

Planning Guide 10/2003 Edition

simodrive

AC Induction Motors
General Section
SIMODRIVE 611/Masterdrives VC/MC

SIEMENS

SIEMENS

SIMODRIVE 611 MASTERDRIVES VC/MC

AC Induction Motors General Section

Planning Guide

| | |
|-------------------|---|
| Electrical Data | 1 |
| Mechanical Data | 2 |
| Connection System | 3 |
| Engineering | 4 |
| References | A |
| Index | |

Designation of the documentation

Printing history

Brief details of this edition and previous editions are listed below.

The status of each edition is shown by the code in the "Remarks" column.

Status code in the "Remarks" column:

- A New documentation
- B Unrevised reprint with new Order No.
- C Revised edition with new status

If factual changes have been made on the page since the last edition, this is indicated by a new edition coding in the header on that page.

| Edition | Order No. for the General Section | Remark |
|----------------|--|---------------|
| 10.03 | 6SN1197-0AC62-0BP0 | A |

This manual is part of the documentation on CD ROM (**DOCONCD**)

| Edition | Order No. | Remark |
|----------------|---------------------|---------------|
| 11.03 | 6FC5 298-6CA00-0BG4 | C |

Trademarks

SIMATIC®, SIMATIC HMI®, SIMATIC NET®, SIROTEC®, SINUMERIK®, SIMODRIVE®, SIMOVERT MASTERDRIVES® and MOTION-CONNECT® are registered trademarks of Siemens AG. Other names in this publication might be trademarks whose use by a third party for his own purposes may violate the rights of the registered holder.

Additional information is available in the Internet under:
<http://www.ad.siemens.de/sinumerik>

This documentation was produced with Interleaf V 7

The reproduction, transmission or use of this document or its contents is not permitted without express written authorization. Offenders will be liable for damages. All rights, including rights created by patent grant or registration of a utility model or design, are reserved.

© Siemens AG 2003. All rights reserved.

Other functions not described in this documentation might be executable in the control. This does not, however, represent an obligation to supply such functions with a new control or when servicing.

We have checked that the contents of this publication agree with the hardware and software described herein. Nonetheless, differences might exist and therefore we cannot guarantee that they are completely identical. The information given in this publication is reviewed at regular intervals and any corrections that might be necessary are made in the subsequent printings. Suggestions for improvement are welcome at all times.

Subject to change without prior notice.

Foreword

Information on the documentation

This document is part of the Technical Customer Documentation which has been developed for SIMODRIVE, SIMOVERT MASTERDRIVES VC (Vector Control) and SIMOVERT MASTERDRIVES MC (Motion Control) drive converter systems. All publications are available individually. The documentation list, which includes all Advertising Brochures, Catalogs, Overview, Short Descriptions, Operating Instructions and Technical Descriptions with order number, ordering address and price can be obtained from your local Siemens office.

This document does not purport to cover all details or variations in equipment, nor to provide for every possible contingency to be met in connection with installation, operation or maintenance.

Furthermore, the contents of this document shall neither become part of nor modify any prior or existing agreement, commitment or relationship. The sales contract contains the entire obligations of Siemens. The warranty contained in the contract between the parties is the sole warranty of Siemens. Any statements contained herein neither create new warranties nor modify the existing warranty.

Structure of the documentation for 1PH and 1PL motors

The complete Planning Guides for 1PH and 1PL motors can be ordered in paper form.

Table Foreword-1 Planning Guide with General Section and 1PH and 1PL6 motors

| Title | Order No. (MLFB) | Language |
|-----------------------------------|--------------------|----------|
| AC Induction Motors, 1PH and 1PL6 | 6SN1197-0AC61-0AP0 | German |
| AC Induction Motors, 1PH and 1PL6 | 6SN1197-0AC61-0BP0 | English |

The General Section and the individual motor series are also separately available.

Table Foreword-2 Planning Guide, individual documents

| Title | Order No. (MLFB) | Language |
|---|--------------------|----------|
| AC Induction Motors, General Section | 6SN1197-0AC62-0AP0 | German |
| AC Induction Motors, Motor Section 1PH2 | 6SN1197-0AC63-0AP0 | German |
| AC Induction Motors, Motor Section 1PH4 | 6SN1197-0AC64-0AP0 | German |
| AC Induction Motors, 1PH7 Motor Section for SIMODRIVE | 6SN1197-0AC65-0AP0 | German |
| AC Induction Motors, 1PH7 Motor Section for SIMOVERT MASTERDRIVES VC/MC | 6SN1197-0AC66-0AP0 | German |
| AC Induction Motors, 1PL6 Motor Section for SIMOVERT MASTERDRIVES VC/MC | 6SN1197-0AC67-0AP0 | German |

Hotline

If you have any questions please contact the following Hotline:

A&D Technical Support Tel.: +49 (180) 5050–222
Fax: +49 (180) 5050–223
eMail: adsupport@siemens.com

Please send any questions regarding the documentation (suggestions, corrections) to the following fax number:

+49 (9131) 98–2176

Fax form: Refer to the response sheet at the end of the document

Definition of qualified personnel

For the purpose of this document and product labels, a qualified person is a person who is familiar with the installation, mounting, start-up and operation of the equipment and hazards involved. He or she must have the following qualifications:

- Trained and authorized to energize, de-energize, ground and tag circuits and equipment in accordance with established safety procedures.
- Trained in the proper care and use of protective equipment in accordance with established safety procedures.
- Trained in rendering first aid.

Explanation of the symbols

The following danger and warning concept is used in this document:



Danger

This symbol is used in the document to indicate that death, severe personal injury or substantial property damage **will** result if proper precautions are not taken.



Warning

This symbol is used in the document to indicate that death, severe personal injury or property damage **can** result if proper precautions are not taken.



Caution

This symbol is used in the document to indicate that minor personal injury or material damage **can** result if proper precautions are not taken.

Caution

This warning (without warning triangle) indicates that material damage **can** result if proper precautions are not taken.

Notice

This warning indicates that an undesirable situation or condition **can** occur if the appropriate instructions/information are not observed.

Note

In this document, it can be advantageous to observe the information provided in a Note.

Danger and warning information



Danger

- Start-up/commissioning is absolutely prohibited until it has been completely ensured that the machine, in which the components described here are to be installed, fully corresponds to the specifications of Directive 98/37/EC.
 - Only appropriately qualified personnel may commission SIMODRIVE and SIMOVERT MASTERDRIVES drive units and the AC motors.
 - This personnel must carefully observe the technical customer documentation belonging to this product and be knowledgeable about and carefully observe the danger and warning information.
 - Operational electrical equipment and motors have parts and components which are at hazardous voltage levels.
 - Hazardous axis motion can occur when working with the equipment.
 - All work must be undertaken with the system in a no-voltage condition (powered-down).
 - SIMODRIVE and SIMOVERT MASTERDRIVES drive units have been designed to be connected to line supplies grounded through a low-ohmic connection (TN line supplies). For additional information please refer to the appropriate documentation for the drive converter systems.
-



Warning

- Perfect and safe operation of these units and motors assumes professional transport, storage, mounting and installation as well as careful operator control and servicing.
 - The information provided in catalogs and quotations additionally applies to special versions of units and motors.
 - In addition to the danger and warning information/instructions in the technical customer documentation supplied, the applicable domestic, local and plant-specific regulations and requirements must be carefully taken into account.
-



Caution

- The motors can have surface temperatures of over +100° C.
 - This is the reason that temperature-sensitive components, e.g. cables or electronic components may neither be in contact nor be attached to the motor.
 - When handling cables, please observe the following
 - They may not be damaged
 - They may not be stressed
 - They may not come into contact with rotating components.
-

Caution

- Motors should be connected up according to the circuit diagram provided. It is not permissible to directly connect the motors to the three-phase line supply as this will destroy the motors.
 - SIMODRIVE and SIMOVERT MASTERDRIVES drive units with AC motors are subject, as part of the type test, to a voltage test corresponding to EN 50178. When the electrical equipment of industrial machines is subject to a voltage test in compliance with EN 60204-1, Section 19.4, all of the connections of the SIMODRIVE and SIMOVERT MASTERDRIVES drive units must be disconnected/withdrawn in order to avoid damaging the SIMODRIVE and SIMOVERT MASTERDRIVES drive units.
-

Note

- SIMODRIVE and SIMOVERT MASTERDRIVES drive units with AC motors fulfill, when operational and in dry equipment rooms, the Low-Voltage Directive 73/23/EEC.
 - SIMODRIVE and SIMOVERT MASTERDRIVES drive units with AC motors fulfill, in the configurations specified in the associated EC Declaration of Conformity, EMC Directive 89/336/EEC.
-

ESDS information



Caution

ElectroStatic Discharge Sensitive devices (ESDS) are individual components, integrated circuits or boards which, when handled, tested or transported, could be destroyed by electrostatic fields or electrostatic discharge.

Handling ESDS boards:

- When handling components which can be destroyed by electrostatic discharge, it must be ensured that personnel, the workstation and packaging are well grounded!
 - Electronic boards may only be touched by personnel in ESDS areas with conductive flooring if
 - they are grounded with an ESDS bracelet
 - they are wearing ESDS shoes or ESDS shoe grounding strips.
 - Electronic boards should only be touched when absolutely necessary.
 - Electronic boards would not be brought into contact with plastics and articles of clothing manufactured from man-made fibers.
 - Electronic boards may only be placed on conductive surfaces (table with ESDS surface, conductive ESDS foam rubber, ESDS packing bag, ESDS transport containers).
 - Electronic boards may not be brought close to data terminals, monitors or television sets. Minimum clearance >10 cm).
 - Measuring work may only be carried-out on the electronic boards, if
 - the measuring unit is grounded (e.g. via a protective conductor) or
 - for floating measuring equipment, the probe is briefly discharged before making measurements (e.g. a bare-metal control housing is touched).
-

Table of Contents

| | | |
|----------|---|-----------------|
| 1 | Electrical Data | AL/1-13 |
| 1.1 | Definition of the terminology | AL/1-13 |
| 1.2 | Mode of operation and power characteristics | AL/1-15 |
| 1.3 | Operation with drive converter systems | AL/1-17 |
| 1.3.1 | Operation on SIMODRIVE 611 | AL/1-17 |
| 1.3.2 | Operation with SIMOVERT MASTERDRIVES | AL/1-18 |
| 1.3.3 | Motor drive converter assignment (power module) | AL/1-19 |
| 1.4 | Motor limits | AL/1-19 |
| 2 | Mechanical Data | AL/2-21 |
| 2.1 | Types of construction | AL/2-21 |
| 2.2 | Vibration severity limit values | AL/2-21 |
| 2.3 | Balancing process | AL/2-23 |
| 2.4 | Natural frequency when mounted | AL/2-24 |
| 2.5 | Permissible vibrations which are externally excited | AL/2-24 |
| 2.6 | Misalignment errors | AL/2-25 |
| 2.7 | Flywheels | AL/2-25 |
| 2.8 | Shaft and flange accuracy | AL/2-26 |
| 2.9 | Degree of protection acc. to EN 60034-5 | AL/2-28 |
| 2.10 | Cooling | AL/2-30 |
| 2.11 | Cantilever and axial force | AL/2-31 |
| 2.11.1 | Cantilever force | AL/2-31 |
| 2.11.2 | Axial force | AL/2-33 |
| 2.12 | Bearing lifetime/bearing change intervals | AL/2-34 |
| 3 | Connection System | AL/3-35 |
| 3.1 | Power and signal cables | AL/3-35 |
| 3.1.1 | Power cable | AL/3-35 |
| 3.1.2 | Connecting-up information | AL/3-37 |
| 3.1.3 | Signal cable | AL/3-38 |
| 4 | Engineering | AL/4-39 |
| 4.1 | Software for engineering and commissioning | AL/4-39 |
| 4.2 | Selecting and dimensioning induction motors | AL/4-40 |
| A | References | AL/A-45 |
| | Index | Index-51 |



Electrical Data

1.1 Definition of the terminology

Mechanical limit speed n_{\max}

The max. permissible speed n_{\max} is determined from the mechanical design (bearings, short-circuit ring of the squirrel cage etc.). It is **not** permissible that this speed is exceeded! The motor may not be continuously operated at this speed. The speed must be reduced according to the following load duty cycle:

| | |
|------|----------------|
| 30 % | n_{\max} |
| 60 % | $2/3 n_{\max}$ |
| 10 % | Standstill |

for a cycle duration of 10 min.

Maximum continuous speed n_{S1}

The maximum permissible speed that is continuously permitted without speed duty cycles.

Speed n_1

The maximum permissible speed at constant power or speed where for $P=P_N$, there is still a 30% power reserve up to the stall limit.

Maximum torque M_{\max}

Torque which is briefly available for dynamic operations (e.g. accelerating).

$$M_{\max} = 2 \cdot M_N$$

S1 duty (continuous operation)

Operation with a constant load the duration of which is sufficient so that the machine goes into a thermal steady-state condition.

1.1 Definition of the terminology

S6 duty (intermittent load)

S6 duty is operation with comprises a sequence of similar load duty cycles; each of these load duty cycles comprises a time with constant motor load and a no-load time. If not otherwise specified, then the power-on time refers to a load duty cycle of 10 min.

e.g. S6 – 40 %: 4 min load
 6 min no-load time

Thermal time constant T_{th}

The thermal time constant defines the temperature rise of the motor winding when the motor load is suddenly increased (step increase) up to the permissible S1 torque. After T_{th} , the motor has reached 63 % of its S1 final temperature.

Core types

Core types are a subset of the overall motor range. Core types have shorter delivery times and are in some cases available ex-stock. The range of options is restricted. The order designation is specifically referred to in the Catalogs.

1.2 Mode of operation and power characteristics

Mode of operation

A constant torque M_N is available from standstill up to the rated operating point.

The constant power range starts at the rated operating point (refer to the P/n diagrams in the Planning Guides of the motor sections).

At higher speeds, i.e. in the constant power range, the maximum available torque M_{\max} at a specific speed n is approximated according to the following formula:

$$M_{\max} [\text{Nm}] < \frac{P_{\max} [\text{W}] \cdot 9550}{n [\text{RPM}]} \quad P_{\max} [\text{W}] = 2 \cdot P_N$$

AC induction motors have a high overload capacity in the constant power range. For some AC motors, the overload capacity is reduced in the highest speed range. The precise data can be taken from the motor characteristics in the appropriate Planning Guides of the motor sections.

The motor field remains constant over the base speed range up to the rated operating point of the motor. This is then followed by a wide constant power range.

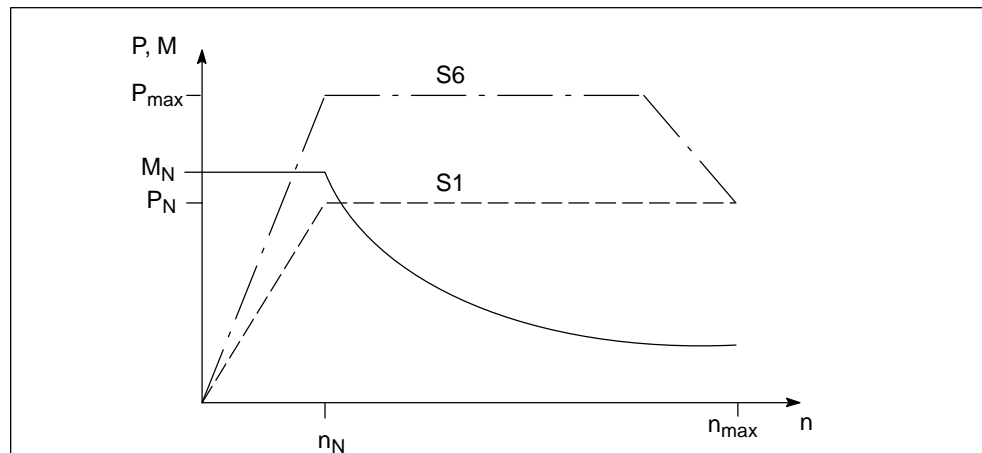

Fig. 1-1 Principle characteristic of power P and torque M as a function of speed n (operating modes acc. to VDE 0530 Part 1)

Power characteristics

For main spindle applications, the constant power range used to machine a work-piece with constant cutting power is extremely important. The required drive converter power can be reduced by optimally utilizing the constant power range.

The following limits and characteristics apply as basis for all AC induction motors fed from drive converters.

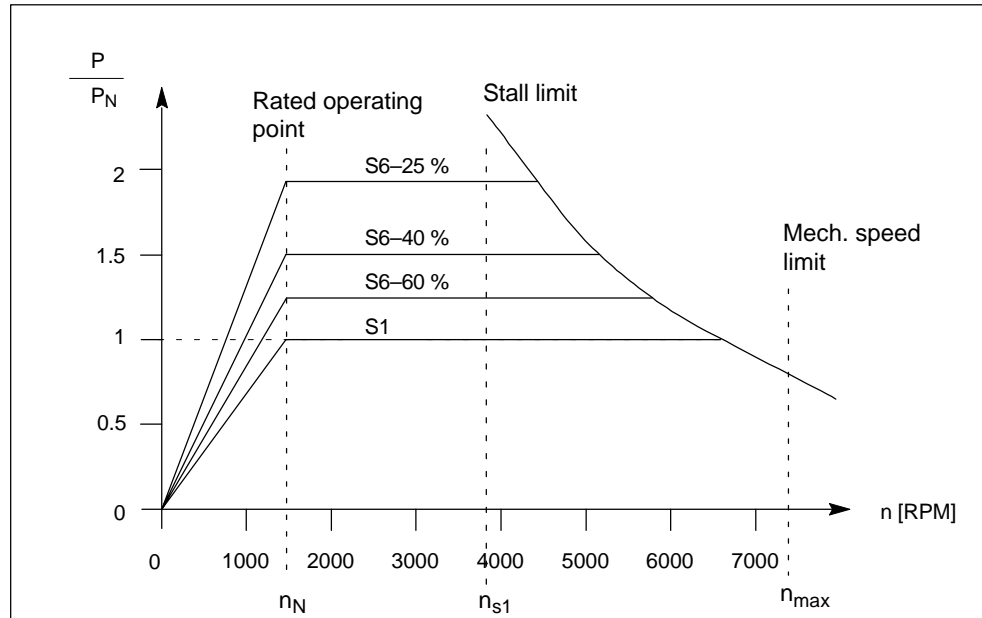

Fig. 1-2 Power characteristics, limits and characteristics

Power–speed diagram

Power ratings for duty types S1 and S6

The operating modes are defined in IEC 60034, Part 1. For duty types S1 and S6, acc. to IEC 60034, Part 1, a maximum load duty cycle of 10 min is defined as long as no other information exists.

All of the AC motor performance data (power etc.) refer to continuous operation and the appropriate duty type S1.

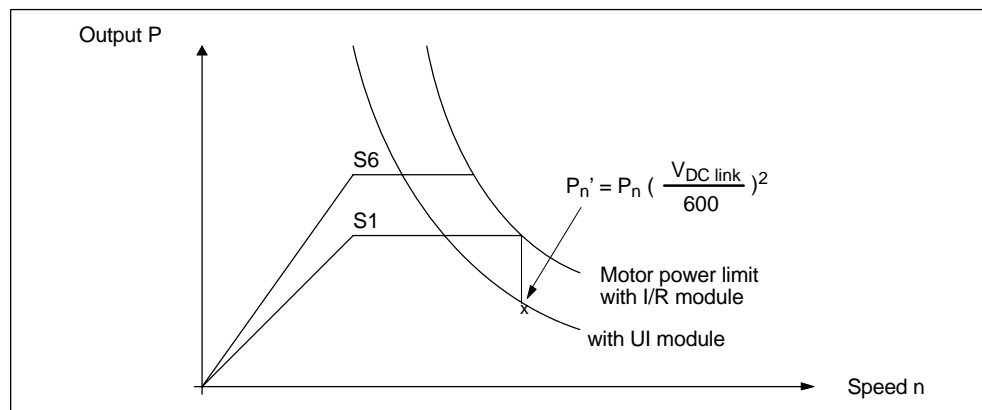

Fig. 1-3 Power-speed diagram (using SIMODRIVE as example)

However, for many applications, duty type S1 does not apply, if e.g. the load varies as a function of time. For this particular case, an equivalent sequence can be specified which represents, as a minimum, the same load for the motor.

Duty type S6... can be considered close to normal applications.

(S6 = continuous operation with intermittent load).

For shorter accelerating times, torque surges or drives which have to handle overload conditions, short-time or peak currents are available in a 60-second cycle. The magnitude of these currents and how the drive converter system is engineered can be taken from the documentation of the relevant drive converter power modules.

1.3 Operation with drive converter systems

1.3.1 Operation on SIMODRIVE 611

The drive modules can be operated from both uncontrolled and controlled supply modules belonging to the SIMODRIVE 611 drive converter system. The engineering and power data of the Catalog refer to operation with the controlled infeed/regenerative feedback modules. This data should be corrected, if required, when operated from uncontrolled infeed modules.

When operating main spindle and induction drive modules with an uncontrolled (non-regulated) infeed (UI module), then a lower maximum motor output is available in the upper speed range than when using the infeed/regenerative feedback module (refer to the diagram).

As a result of the lower DC link voltage of 490 V, for the UI module, the available continuous output is given by:

1.3 Operation with drive converter systems

If $V_{DC\ link} < 1.5 U_{ZN\ motor}$ then the motor can only provide its continuous power

$$P_{cont} = P_N \cdot \frac{V_{DC\ link}}{1.5 \cdot U_{N\ motor}} \quad \text{at the rated speed.}$$

| | |
|----------------|--------------------------|
| $V_{DC\ link}$ | 490 V for a UI module |
| $V_{DC\ link}$ | 600 V for and I/R module |

These values apply for a 400 V line supply.

For the UI module, it must be also be observed that the braking energy, which is fed-in, does not exceed the power rating of the pulsed resistor:

- 5 kW infeed module
 - 200 W continuous power (regenerative feedback power)
 - 10 kW short-time output for 120 ms, once per 10 s operating cycle without pre-load condition
- 10 kW infeed module
 - 300 W continuous power (regenerative feedback power)
 - 25 kW short-time output for 120 ms, once per 10 s operating cycle without pre-load condition
- 28 kW infeed module
 - max. 2 x 300 W continuous power
 - max. 2 x 25 kW short-time power for 120 ms, once per 10 s operating cycle without pre-load condition
 or
 - max. 2 x 1.5 kW continuous power
 - max. 2 x 25 kW short-time power for 12 ms, once per 10 s operating cycle without pre-load condition

For higher regenerative feedback powers, a separate pulse resistor module must be provided or the regenerative feedback power must be reduced by using longer braking times.

1.3.2 Operation with SIMOVERT MASTERDRIVES

1PH and 1PL AC induction motors can be fed from the MASTERDRIVES drive converter system for line supply voltages of 3-ph. 380 V to 480 V AC.

The data for line supply voltages of 400 V and 460/480 V are specified in the Catalog and in the Planning Guide.

In this case, it was taken into account that the Vector Control (VC) and Motion Control (MC) control versions, for the same drive converter input voltage, provide different maximum drive converter output voltages:

- Vector Control (VC):
 - Max. drive converter output voltage = drive converter input voltage
- Motion Control (MC):
 - Max. drive converter output voltage $\approx 0.86 \cdot$ drive converter input voltage

Additional data on the drive converters as well as different infeed units should be taken from the Planning Guide of the drive converter.

1.3.3 Motor drive converter assignment (power module)

If the rated drive converter current exceeds the rated motor current, then the thermal characteristic (S1) of the motor determines the continuous power of the combination.

Result: The drive converter is therefore not fully utilized.

In the inverse case, the rated drive converter current defines the available continuous power.

Result: The motor isn't thermally fully utilized.

If the drive system is operated using load duty cycles, then the motor must be selected so that the RMS current values do not exceed the permissible S1 value of the motor.

The following generally applies:

If a range is defined by two limit values or characteristics, then the lower limit defines the usable range.

1.4 Motor limits

The speed and power of induction motors are limited for thermal and mechanical reasons¹⁾.

Thermal limiting

The characteristics for continuous duty S1 and intermittent operation S6–60 %, S6–40 % and S6–25 % describe the permissible power values for an ambient temperature of up to 40 °C. A winding temperature rise of approx. 105 K can occur.

Mechanical limiting

It is not permissible that the mechanical limit speed is exceeded. If this speed is exceeded, then this can result in damage to the bearings, short-circuit end rings, press fits etc. It should be ensured that higher speeds are not possible by appropriately designing the control or by activating the speed monitoring in the drive converter.

1) Load on the shaft end; bearing stressing



Mechanical Data

2.1 Types of construction

| Type of constr. | Designation | Type of constr. | Designation | Type of constr. | Designation |
|---|-------------|---|-------------|---|-------------|
|  | IM B3 |  | IM B5 |  | IM B35 |
|  | IM V5 |  | IM V1 |  | IM V15 |
|  | IM V6 |  | IM V3 |  | IM V36 |

Fig. 2-1 The various types of construction

2.2 Vibration severity limit values

High cantilever force loads cannot be handled at high speed and with high vibration quality. The reason for this is that the different applications require different bearings.

2.2 Vibration severity limit values

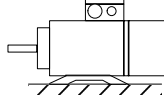
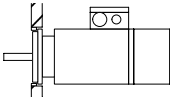
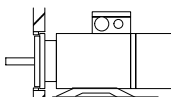
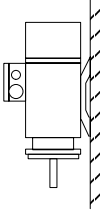
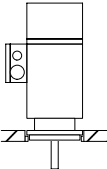
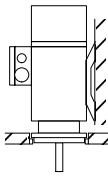
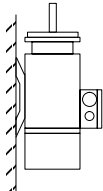
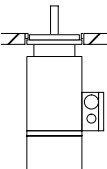
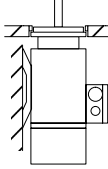
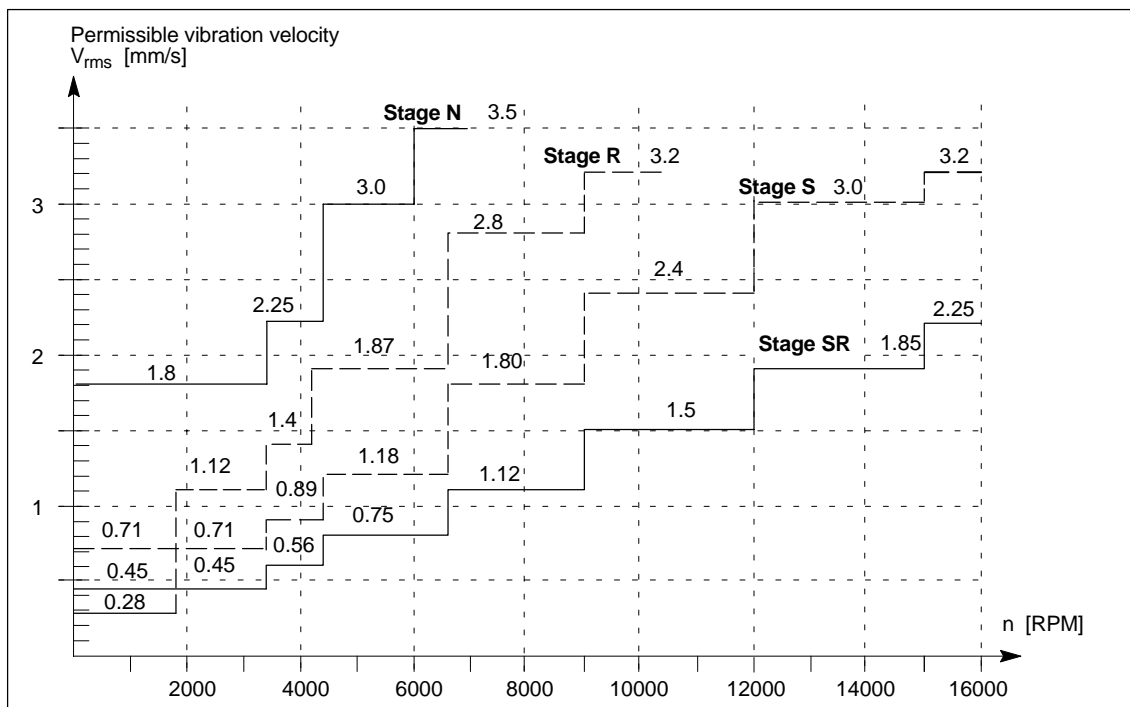

Fig. 2-2 Vibration severity stages – limit values for the AC induction motors, shaft heights 100 to 132

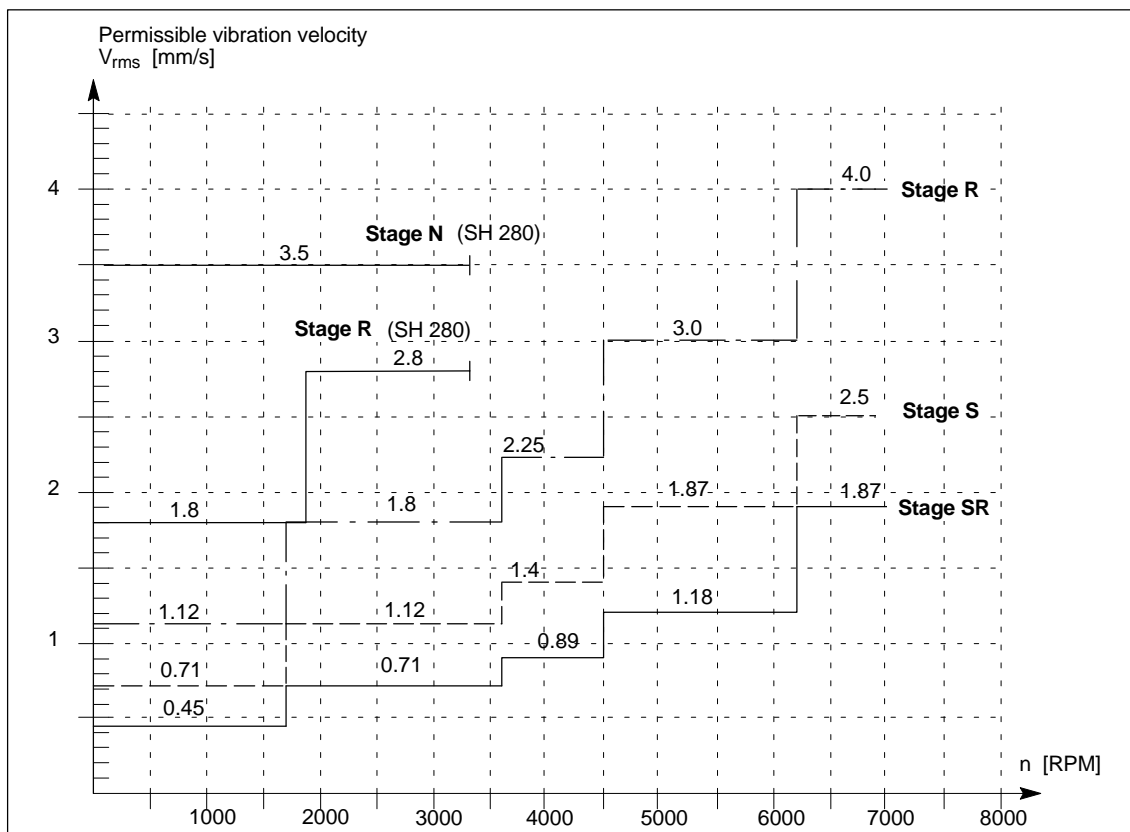

Fig. 2-3 Vibration severity stages - limit values for AC induction motors, shaft heights 160 to 280

2.3 Balancing process

Requirements placed on the process when balancing mounted components – especially pulley wheels

In addition to the balance quality of the motor, the vibration quality of motors with mounted belt pulleys and coupling is essentially determined by the balance quality of the mounted component.

If the motor and mounted component are separately balanced before they are assembled, then the process used to balance the belt pulley or coupling must be adapted to the motor balancing type.

For induction motors, a differentiation should be made between the following balancing types:

- Half key balancing (an "H" is stamped on the shaft face)
- Full key balancing (an "F" is stamped on the shaft face)
- Smooth shaft end (no keyway)

The balancing type is coded in the order designation.

For the highest demands placed on the system balance quality, we recommend that motors with smooth shaft (without keyway) are used. For motors balanced with full key, we recommend belt pulleys with two keyways on opposite sides, however, with only one key in the shaft end.

Table 2-1 Requirements placed on the balancing process as a function of the motor balancing type

| Balancing equipment/process step | Motor balanced with half key | Motor balanced with full key | Motor with smooth (no keyway) shaft end |
|--|---|---|--|
| Auxiliary shaft to balance the mounted component | <ul style="list-style-type: none"> • Auxiliary shaft with keyway • Keyway with the same dimensions as the motor shaft end • Auxiliary shaft, balanced with half key | <ul style="list-style-type: none"> • Auxiliary shaft with keyway • Keyway design with the exception of the keyway width (the same as the motor) can be freely selected • Auxiliary shaft, balanced with full key | <ul style="list-style-type: none"> • Auxiliary shaft without keyway • If required, use a tapered auxiliary shaft |
| | <ul style="list-style-type: none"> • Balance quality of the auxiliary shaft $\leq 10\%$ of the required balance quality of the component to be mounted to the motor | | |
| Attaching the mounted component to the auxiliary shaft for balancing | <ul style="list-style-type: none"> • Retaining with key • Key design, dimensions and material the same as the motor shaft end | <ul style="list-style-type: none"> • Retaining with key • Key design, dimensions and material as for the full-key balancing of the auxiliary shaft are used | <ul style="list-style-type: none"> • It should be retained with as little play as possible, e.g. light press fit on a tapered shaft |
| Position the mounted component on the auxiliary shaft | <ul style="list-style-type: none"> • Select a position between the mounted component and the key of the auxiliary shaft so that it is the same when mounted on the actual motor | <ul style="list-style-type: none"> • No special requirements | |
| Balance the mounted component | <ul style="list-style-type: none"> • Two-plane balancing – this means that we recommend balancing in two planes at both sides of the mounted component at right angles to the axis of rotation | | |

2.4 Natural frequency when mounted

Special requirements

If special requirements are placed on the smooth running operation of the machine, we recommend that the motor together with the drive-out component is completely balanced. In this case, balancing should be carried-out in two planes of the drive-out component.

2.4 Natural frequency when mounted

System-specific vibration characteristics

When the motor is mounted to the machine/system (flange-mounting is predominantly used) and coupled to the mechanical transmission shaft, vibration characteristics are obtained according to the specific system.

The vibration characteristics depend on the stiffness of the motor foundation. For a rigid coupling, the smooth running characteristics of the drive mechanical transmission are also important. These factors can result in increased vibration values at the motor and for example, for machine tools, in poor machining quality.

Measures to reduce vibration levels

Depending on the actual operating conditions, vibrations can be reduced by applying the following measures:

- Stiffer motor foundation
- Additionally supporting the motor on the B side (for flange mounting)
- By de-coupling the system from the source of vibration or damping the drive mechanical shaft

2.5 Permissible vibrations which are externally excited

External vibrations are introduced into the motor through the motor foundation and/or the drive mechanical transmission through the motor frame and/or through the rotor. In order to ensure perfect functioning of the drive as well as a long motor lifetime, these types of vibrations, introduced into the drive system, should not exceed the specific limit values of the motor.

Vibrations caused by the rotor must be minimized by appropriately balancing the motor (refer to Chapter 2.3).

2.6 Misalignment errors

In order to avoid misalignment errors or to keep them as low as possible, an equalizing coupling should be used (refer to Fig. 2-4).

If possible, the motor should not be directly and rigidly coupled to a drive-out transmission shaft which has its own bearings.

However, if a rigid coupling is absolutely necessary due to mechanical design reasons, misalignment deviations must be avoided. In this case, a careful check must be made by making the appropriate measurements.

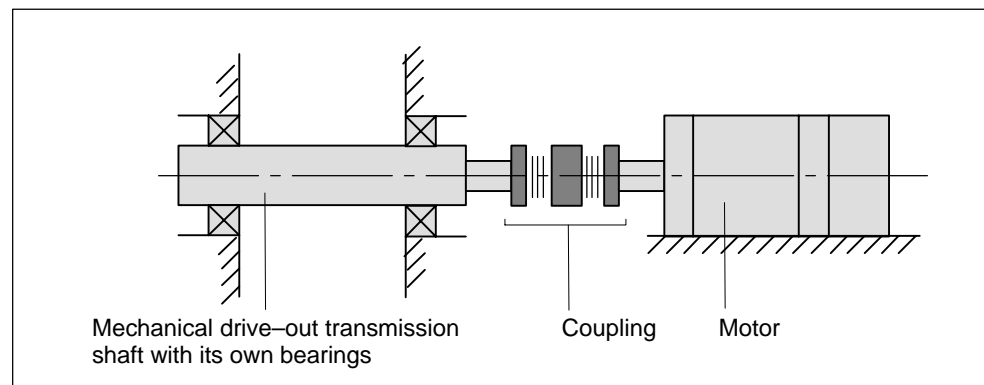

Fig. 2-4 Mechanical drive-out transmission shaft with its own bearings and equalization coupling

2.7 Flywheels

Flywheels with a high mass, which are rigidly mounted to the end of the motor shaft, modify the vibration characteristics of the motor and shift the critical rotational frequencies of the motor into the lower speed ranges.

The overall system should be precision balanced in order to minimize/avoid exciting vibration, when external masses are directly mounted onto the motor shaft.

Operation in the resonance range should be avoided.

2.8 Shaft and flange accuracy

The shaft and flange accuracies are checked according to DIN 42955, IEC 60072. Data, which deviate from these values, is entered into the dimension drawings (refer to the Planning Guide of the appropriate motor).

Table 2-2 Radial eccentricity tolerance of the shaft to the frame axis (referred to cylindrical shaft ends)

| Shaft height | Tolerance, stage N | Tolerance, stage R |
|--------------|--------------------|--------------------|
| 100 | 0.05 | 0.025 |
| 132 | 0.05 | 0.025 |
| 160 | 0.06 | 0.03 |
| 180 | 0.06 | 0.03 |
| 225 | 0.06 | 0.03 |
| 280 | 0.07 | 0.035 |

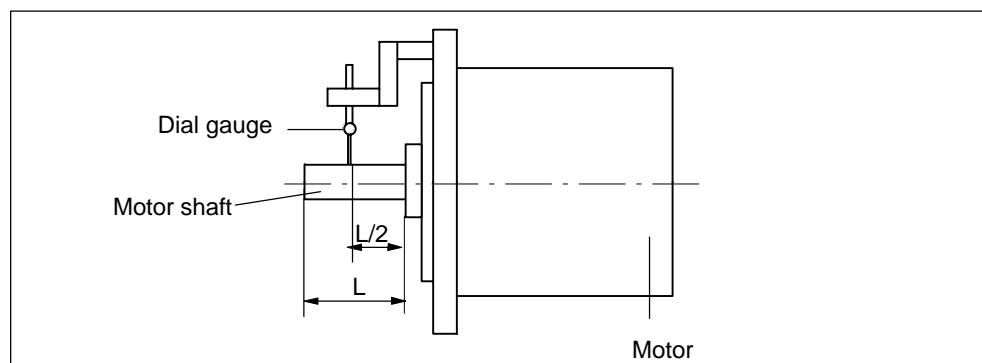

Fig. 2-5 Checking the radial eccentricity

Table 2-3 Concentricity and axial eccentricity tolerance of the flange surface to the shaft axis (referred to the centering diameter of the mounting flange)

| Shaft height | Tolerance, stage N | Tolerance, stage R |
|--------------|--------------------|--------------------|
| 100 | 0.1 | 0.05 |
| 132 | 0.125 | 0.063 |
| 160 | 0.125 | 0.063 |
| 180 | 0.125 | 0.063 |
| 225 | 0.125 | 0.063 |
| 280 | 0.16 | 0.08 |

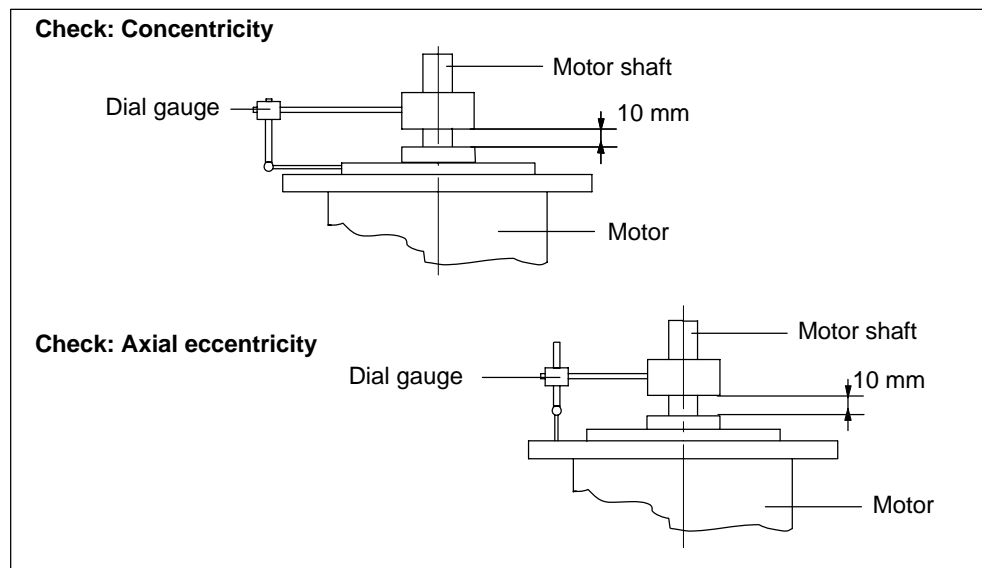

Fig. 2-6 Checking the concentricity and axial eccentricity

2.9 Degree of protection acc. to EN 60034-5

Degree of protection of electric motors is specified by a code. This comprises 2 letters, 2 digits and if required, an additional letter. The motors are assigned to degrees of protection IP□□ after the test objects have been subject to a type test test.

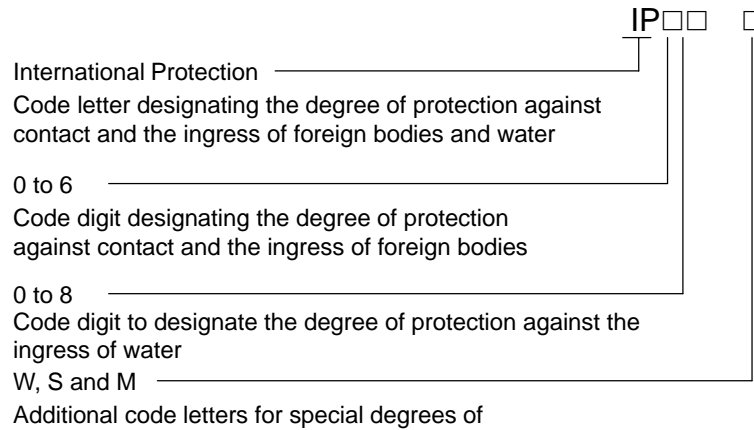

Table 2-4 Description of the various degrees of protection

| Motor | Degree of protection | 1st digit | | 2nd digit |
|-----------------------------|---|-------------------------------------|---|---|
| | | Contact protection | Protection against foreign bodies | Protection against water |
| Open-circuit cooling | IP23 | Protection against finger contact | Protection against medium-sized, solid foreign bodies above 12 mm Ø | Protection against spray water up to 60° to the vertical |
| Totally enclosed fan cooled | IP 54 | Complete shock protection | Protection against damaging dust deposits | Spray water from every direction |
| | IP55 | | | Jets of water from every direction |
| | IP64 | Complete protection against contact | Protection against the ingress of dust | Spray water from every direction |
| | IP65 ¹⁾ | | | Jets of water from every direction |
| | IP67 ¹⁾ | | | Motor immersed in water under specific pressure and time conditions |
| IP68 ¹⁾ | Motor can be completely submersed in water under conditions which the manufacturer must specify | | | |

1) According to DIN VDE 0530 Part 5 or EN 60034 Part 5, for the 1st digit, there are only 5 degrees of protection and for the 2nd code, 8 degrees of protection for rotating electrical machinery. IP6 is included in DIN 40050 which generally applies to electrical equipment.

When assigning motors to a specific degree of protection Class, a standardized, brief test procedure is applied. This can deviate significantly from the actual ambient conditions where the motor is installed.

Depending on these ambient conditions— such as the chemical properties of dusts or the cooling media used at the installation site – it is only conditionally possible to evaluate the suitability of the motor for the particular environment using the degree of protection (e.g. electrically conductive dusts or aggressive cooling medium vapors or liquids).

In cases such as these, the motor must be additionally protected using the appropriate measures.

Even for versions with shaft sealing ring, liquids should be avoided from collecting.

2.10 Cooling

Ambient/cooling medium temperature

Operation: $T = -15\text{ °C}$ to $+40\text{ °C}$ (without any restrictions)

Bearing design: $T = -20\text{ °C}$ to $+70\text{ °C}$

For different conditions (ambient temperature $> 40\text{ °C}$ or installation altitudes $> 1000\text{ m}$ above sea level), the permissible torque/power must be determined using factors from Table 2-5 (torque/power reduction in compliance with EN 60034–6).

Please contact your local Siemens office for ambient temperatures $> 50\text{ °C}$.

The ambient temperature and installation altitude are rounded-off to 5 °C or 500 m .

Table 2-5 Torque/power reduction factors

| Installation height above sea level | Ambient temperature in °C | | |
|-------------------------------------|---------------------------|------|------|
| | 40 | 45 | 50 |
| 1000 | 1.00 | 0.96 | 0.92 |
| 1500 | 0.97 | 0.93 | 0.89 |
| 2000 | 0.94 | 0.90 | 0.86 |
| 2500 | 0.90 | 0.86 | 0.83 |
| 3000 | 0.86 | 0.82 | 0.79 |
| 3500 | 0.82 | 0.79 | 0.75 |
| 4000 | 0.77 | 0.74 | 0.71 |



Caution

The surface of motors can reach temperatures of over 100 °C .

Air-cooled motors

The cooling air must be able to freely enter and leave the motor. Accumulated dirt in the cooling ducts should be avoided as this can reduce the cooling airflow.

If necessary, the cooling ducts must be regularly cleaned depending on the degree of pollution at the location where the motor is installed (e.g. using dry, oil-free compressed air).

Water-cooled motors

For water-cooled motors, the cooling conditions (intake temperature, water flow rate, cooling power) must be maintained. If required, the cooling medium should be cleaned using a filter before it enters the motor cooling circuit.

2.11 Cantilever and axial force

2.11.1 Cantilever force

Specific cantilever forces may not be exceeded in order to guarantee perfect operation.

For various shaft heights, a minimum force may not be fallen below. This can be taken from the cantilever force diagrams.

The cantilever force diagrams in the motor sections specify the cantilever force F_Q

- at various operating speeds
- as a function of the bearing lifetime

The force diagrams and tables only apply for standard drive shaft ends. If smaller shaft diameters are used, only reduced cantilever forces may be transmitted or none at all.

For force levels going beyond these, please contact your local Siemens office.



Caution

- For coupling and belt out-drives:

If you use force transmission elements which subject the shaft end to a cantilever force, then it must be ensured that the maximum limit values, specified in the cantilever force diagrams, are not exceeded.

- Only for belt out-drives (shaft heights 180 to 280):

For applications with an extremely low cantilever force load, it should be observed, that the motor shaft is subject to a minimum cantilever force load as specified in the diagrams. Low cantilever forces can cause the bearings to roll in an undefined fashion which results in increased bearing wear.

For applications with cantilever loads, which are less than the specified minimum cantilever forces (e.g. coupling outdrive), then the bearings may not be used for belt outdrives. For applications such as these, the induction motor must be ordered with bearings for coupling out-drive.



Caution

When using elements which increase the force/torque (e.g. gearboxes, brakes) then it must be ensured that the higher forces are not absorbed through the motor.

Important

The cantilever forces at the shaft end must be precisely dimensioned according to the guidelines laid-down by the belt manufacturer. The belt tension must be adjusted using the appropriate measuring equipment.

Calculating the total cantilever force F_Q for belt out-drives

If the belt manufacturer hasn't provided accurate cantilever force data, then this can be appropriately determined using the following formula:

$$F_Q [N] = c \cdot F_U \qquad F_U [N] = 2 \cdot 10^7 \cdot P / (n \cdot D)$$

Table 2-6 Explanation of the formula abbreviations

| Formula abbreviations | Units | Description |
|-----------------------|-------|--|
| c | — | Pre-tensioning factor: The pre-tensioning factor is an experience value provided by the belt manufacturer. It can be assumed as follows: For the V belts: $c = 1.5$ to 2.5 For special plastic belts (flat belts) depending on the load type and belt type $c = 2.0$ to 2.5 |
| F_U | N | Circumferential force |
| P | kW | Motor output |
| n | RPM | Motor speed |
| D | mm | Diameter of belt pulley |

2.11.2 Axial force

The axial force acting on the locating bearings comprises an external axial force (e.g. gearbox with helical gearing, machining forces through the tool), a bearing pre-load force and possibly the force due to the weight of the rotor when the motor is vertically mounted. This results in a maximum axial force that is a function of the direction.

When using, for example, helical toothed wheels as drive element, in addition to the radial force, there is also an axial force on the motor bearings. For axial forces in the direction of the motor, the pre-loading of the bearing can be overcome. This must be prevented, as under certain circumstances, the bearing pre-loading is cancelled which means that the bearing lifetime could be reduced.

The permissible axial force F_{AZ} in operation depends on the motor mounting position (refer to Fig. 2-7).

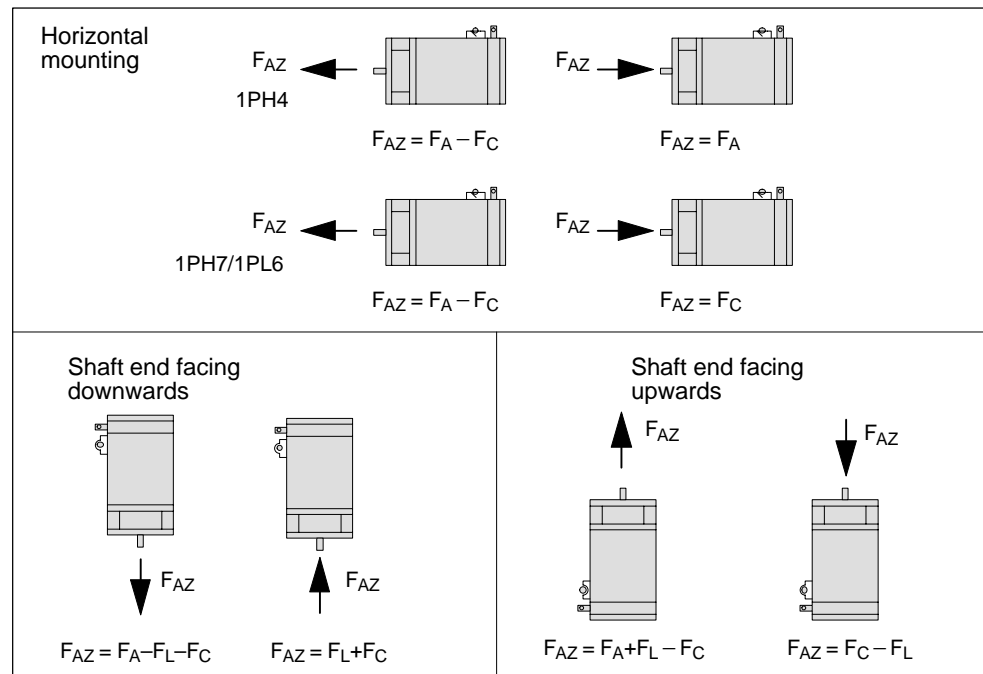

Fig. 2-7 Permissible axial force for 1PH- and 1PL-motors

- F_{AZ} Permissible axial force in operation
- F_A Permissible axial force depending on the average speed
- F_C Pre-loading force – refer to the appropriate motor documentation
- F_L Force due to the weight of the rotor – refer to the appropriate motor documentation

2.12 Bearing lifetime/bearing change intervals

The bearing lifetime has been reached if the bearing fails due to fatigue (mechanical overload) or can no longer be used due to wear (if the lubrication fails).

In order to avoid subsequent damage if a motor bearing fails, we recommend that the bearings are replaced after a certain operating time. The recommended values depend on the operating conditions and are noted in the product specifications.

When replacing the motor bearings, we also recommend that motor encoders with their own bearings are also replaced.

Data relating to fatigue lifetime and grease lifetime are only statistical values and cannot be guaranteed.



3.1 Power and signal cables

Pre-assembled cables offer many advantages over cables assembled by customers themselves. In addition to the security of perfect functioning and the high quality, there are also cost benefits.

Note

Use the power and signal cables from the MOTION CONNECT family. The maximum cable lengths should be carefully observed.

In order to avoid disturbing effects (e.g. as a result of EMC), the signal cables must be routed separately away from power cables.

Refer to Catalog NC Z for technical data and ordering information.

3.1.1 Power cable



Caution

Carefully observe the current which the motor draws for your particular application! Adequately dimension the connecting cables in accordance with IEC 60204-1.

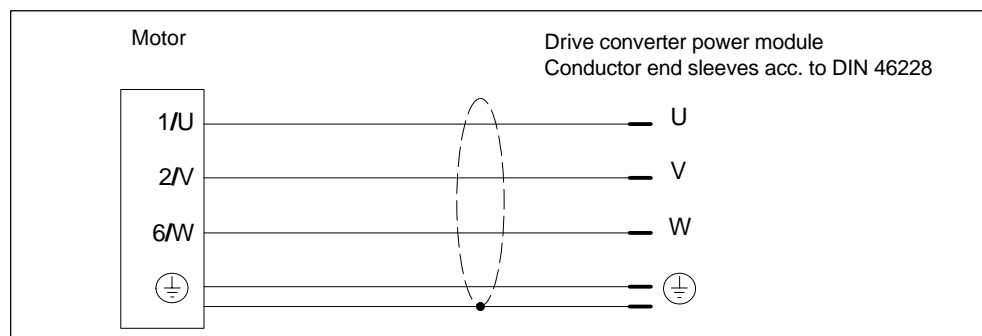

Fig. 3-1 Power cable

Note

The cables are available in a UL version or for higher mechanical requirements.

Cross-sections

When connecting cables to the terminal board, the connecting cables must be dimensioned corresponding to the rated current and the size of the cable lugs must match the dimensions of the terminal studs.

Table 3-1 Current load capacity acc. to IEC EN 60204-1 for PVC-insulated cables with copper conductors for an ambient temperature 40°C and routing type C (cables and conductors attached to walls and in cable trays)

| I_{rms} at +40 °C [A] | Required cross-section [mm ²] | Comments |
|-------------------------|---|--|
| 11.7 | 1 | Correction factors regarding the ambient temperature and routing type should be taken from IEC EN 60204-1. |
| 15.2 | 1.5 | |
| 21 | 2.5 | |
| 28 | 4 | |
| 36 | 6 | |
| 50 | 10 | |
| 66 | 16 | |
| 84 | 25 | |
| 104 | 35 | |
| 123 | 50 | |
| 155 | 70 | |
| 192 | 95 | |
| 221 | 120 | |
| > 221 | For current loads of > 220 A, the required cross-sections can be dimensioned in accordance with DIN VDE 0298. | |

3.1.2 Connecting-up information

Note

The system compatibility is only guaranteed if shielded power cables are used, the shield is connected to the metal motor terminal box through the largest possible surface area (using metal EMC cable glands).

Shields must be incorporated in the protective grounding concept. Protective ground should be connected to conductors which are open circuit and which are not being used and also electrical cables which can be touched. If the brake feeder cables in the SIEMENS cable accessories are not used, then the brake conductor cores and shields must be connected to the cabinet ground. (Open-circuit cables result in capacitive charges!)



Warning

- Before carrying out any work on the AC motor, please ensure that it is powered-down and the system is locked-out so that the motor cannot re-start!
 - Please observe the rating plate data and circuit diagram in the terminal box. Appropriately dimension the connecting cables.
-

- Twisted or three-core cables with additional ground conductor should be used as motor cables. The insulation should be removed from the ends of the conductors so that the remaining insulation extends up to the cable lug or terminal.
- The connecting cables should be freely arranged in the terminal box so that the protective conductor has an overlength and the cable conductor insulation cannot be damaged. Connecting cables should be appropriately strain relieved.
- The following minimum air clearances must be maintained:
for supply voltages up to 500 V minimum air clearance 4.5 mm
for supply voltages up to 690 V minimum air clearance 10 mm
- After connecting-up, the following should be checked
 - the inside of the terminal box is clean and there are no bits of cables in it,
 - all of the terminal screws are screwed tightly,
 - minimum air clearances are maintained,
 - the cable entries are reliably sealed,
 - unused cable entry glands are closed and the caps are tightly screwed in and
 - all of the sealing surfaces are in a good condition.

Press drive

Note

For press drives with acceleration rates > 2 g, special measures are required. Please contact your local Siemens office.

The power cables for 1PH motors are selected according to the rated motor current I_n at +40 °C according to Table 3-1.

3.1.3 Signal cable

The signal cable used is described in the Planning Guide of the appropriate motor section.

In order to avoid disturbances (e.g. as a result of EMC), the signal cables must be routed separately away from power cables.



4.1 Software for engineering and commissioning

Engineering software for the SIMOVERT MASTERDRIVES drive units

The PATH plus engineering software is a comprehensive, user-friendly engineering tool.

The program can be used to simply engineer AC converter drives from the SIMOVERT MASTERDRIVES Vector Control and Motion Control families thus saving considerable amounts of time.

PATH Plus is a powerful engineering tool which supports the user in all engineering steps from the supply up to the motor.

Order No. for the full version of PATH Plus: 6SW1710-0JA00-2FC0

Commissioning software for SIMODRIVE

Additional commissioning software is available to commission AC induction motors connected to the SIMODRIVE drive converter system.

Order No. [MLFB] for software 6SN1153-2AX10-□AB□5

Order No. [MLFB] for documentation 6SN1197-0AA30-0□B□

NCSD configurator

You simply tell the Configurator the requirements placed on your SINUMERIK/ SIMODRIVE system and the conditions under which you wish to operate this system. The Configurator converts this data and provides you with a complete open-loop control and drive configuration optimized to your particular application. In addition, you are also told which accessories should be used in order to guarantee a safe reliable connection between the various components.

For additional information and to download this engineering tool, refer to Siemens Intranet: www.siemens.de/intranet/mc or Internet: www.siemens.de/motioncontrol

Enter "NCSD Configurator" in the index!

4.2 Selecting and dimensioning induction motors

A differentiation must be made between 3 applications when selecting a suitable induction motor:

- Case 1: The motor essentially operates in continuous duty.
 Case 2: A periodic load duty cycle defines how the drive is dimensioned.
 Case 3: A wide field weakening range is required.

Case 1

A motor should be selected whose S1 output is the same or greater than the required drive output.

Using the P/n diagrams, a check should be made as to whether the power is available over the required speed range. It may be necessary to select a larger motor.

Case 2

The load duty cycle determines how the drive is dimensioned.

It is assumed that the speeds during the load duty cycle lie below the rated speed.

If the torques during the load duty cycle are not known, but only the power, then the power should be converted into a torque using the following equation:

$$M = P \cdot 9550 / n \quad M \text{ in [Nm], } P \text{ in [kW], } n \text{ in [RPM]}$$

The torque to be generated by the motor comprises the frictional torque M_{friction} , the load torque of the driven machine M_{load} and the accelerating torque M_{B} :

$$M = M_{\text{friction}} + M_{\text{load}} + M_{\text{B}}$$

The accelerating torque M_{B} is calculated as follows:

$$M_{\text{B}} = \frac{\pi}{30} \cdot J_{\text{motor+load}} \cdot \frac{\Delta n}{t_{\text{B}}} = \frac{J_{\text{motor+load}} \cdot \Delta n}{9.55 \cdot t}$$

| | |
|-------------------------|---|
| M_{B} | Accelerating torque in Nm referred to the motor shaft (on the motor side) |
| $J_{\text{motor+load}}$ | Total moment of inertia in kgm^2 (on the motor side) |
| Δn | Speed range in RPM |
| t_{B} | Accelerating time in s |

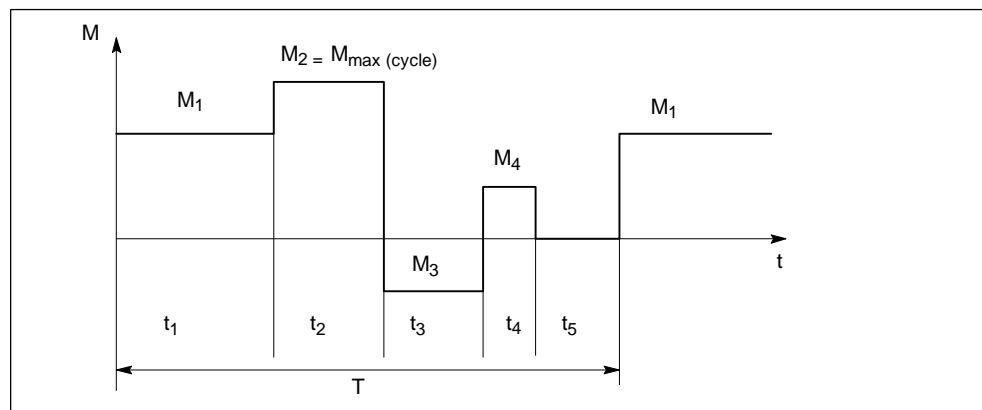

Fig. 4-1 Load duty cycle with 1PH7 motor

The M_{rms} torque must be calculated from the load cycle:

$$M_{\text{rms}} = \sqrt{\frac{M_1^2 \cdot t_1 + M_2^2 \cdot t_2 \dots}{T}}$$

Selecting a motor

A differentiation should be made depending on the period T and the thermal time constant T_{th} that is dependent on the shaft height:

- $T/T_{\text{th}} \leq 0.1$ (for a period duration of 2 to 4 min)

A motor with the rated torque M_{N} should be selected:

$$M_{\text{N}} > M_{\text{rms}} \text{ and } M_{\text{max (cycle)}} < 2M_{\text{N}}$$

- $0.1 \leq T/T_{\text{th}} \leq 0.5$ (for a period duration of approx. 3 min up to approx. 20 min)

A motor with rated torque M_{N} should be selected:

$$M_{\text{N}} > \frac{M_{\text{rms}}}{1.025 - 0.25 \cdot \frac{T}{T_{\text{th}}}} \text{ and } M_{\text{max (cycle)}} < 2M_{\text{N}}$$

- $T/T_{\text{th}} > 0.5$ (for a period duration of approx. 15 min)

If torques above M_{N} of longer than $0.5 T_{\text{th}}$ occur during the load cycles, then a motor with rated torque $M_{\text{N}} > M_{\text{max (cycle)}}$ should be selected.

Selecting a drive converter

The required currents for overload are specified in the power–speed diagrams (powers for S6–25 %, S6–40 %, S6–60 %). Intermediate values can be interpolated.

Example

Moment of inertia of the motor + load: $J = 0.2 \text{ kgm}^2$, friction can be neglected.

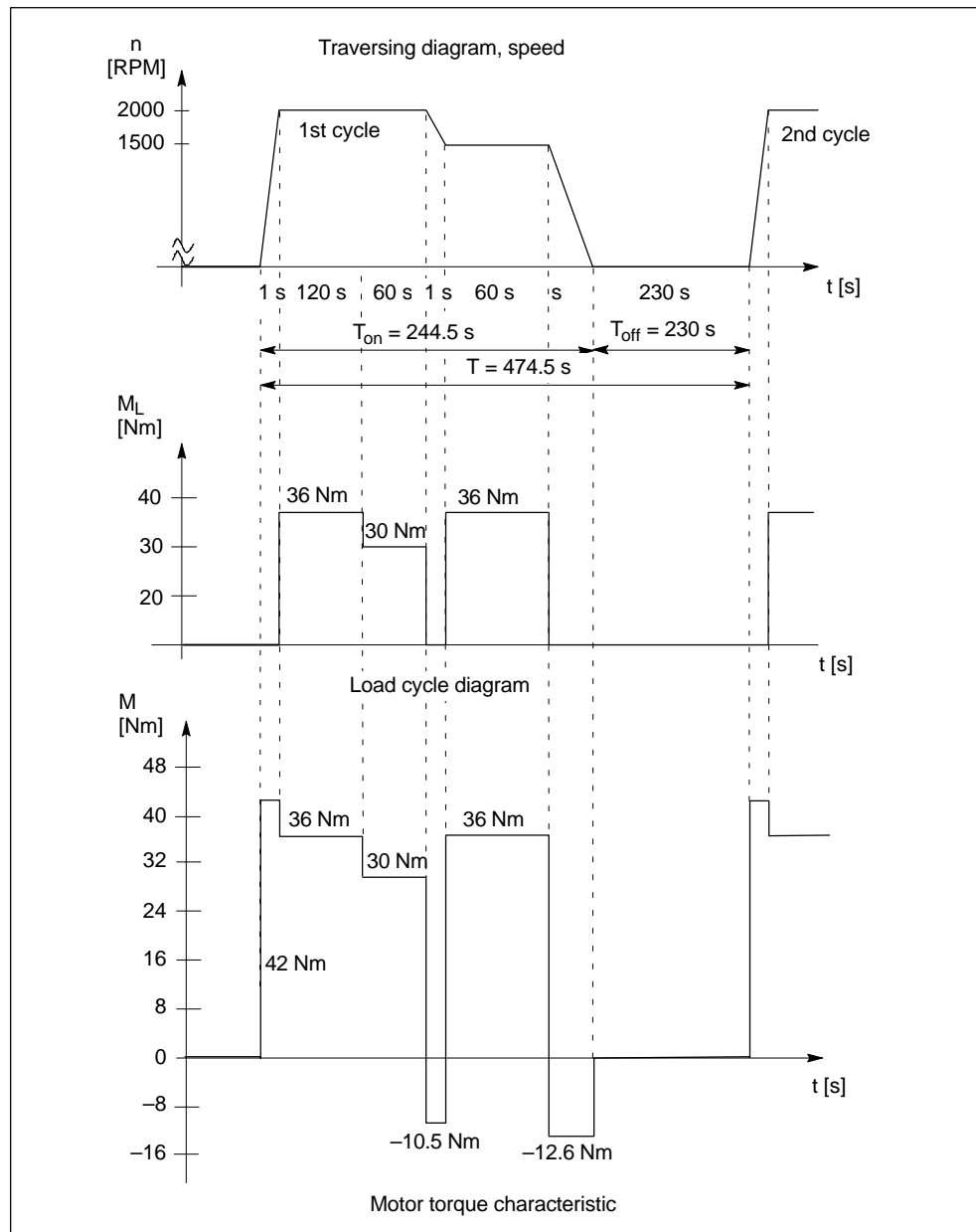

Fig. 4-2 Load duty cycle for the example

Calculating the accelerating torques

$$M_B = \frac{J * \Delta n}{9.55 * t_a}$$

Acceleration for 1 s from 0 to 2000 RPM:

$$M_B = \frac{0.2 * 2000}{9.55 * 1} \quad Nm = 41.8 Nm \approx 42 Nm$$

Braking for 1 s from 2000 to 1500 RPM:

$$M_B = \frac{0.2 * (-500)}{9.55 * 1} = -10.5 Nm$$

Braking for 2.5 s from 1500 to 0 RPM:

$$M_B = \frac{0.2 * (-1500)}{9.55 * 2.5} = -12.6 Nm$$

Max. torque M_{max} : 42 Nm for 1 s

Calculating the RMS motor torque in the operating cycle

$$M_{rms} = \sqrt{\frac{M_1^2 * t_1 + M_2^2 * t_2 + \dots + M_n^2 * t_n}{T}}$$

$$M_{rms} = \sqrt{\frac{42^2 * 1 + 36^2 * 120 + 30^2 * 60 + (-10.5)^2 * 1 + 36^2 * 60 + (-12.6)^2 * 2.5}{474.5}}$$

$$M_{rms} = 24.7 Nm \approx 25 Nm$$

Selecting a motor

| | | |
|----------------|-----------------------------|----------|
| With the data: | Speed | 2000 RPM |
| | Max. motor torque M_{max} | 42 Nm |
| | RMS motor torque: | 25 Nm |

A motor with $n_n = 2000$ RPM, $M_n \geq 25$ Nm should be selected from the torque characteristics (refer to the Planning Guide of the appropriate motor).

Selecting a drive converter

From the power–speed diagram:

The power at the rated speed and 42 Nm maximum torque should be entered. The current requirement should be determined from the characteristics.

Case 3

A higher-field-weakening range is required

Proceed as follows for applications with a field-weakening range greater than for standard induction motors as listed in the motor documentation:

Starting from the max. speed n_{\max} and the power P_{\max} specified there, a motor should be selected which provides the required power P_{\max} at this operating point (n_{\max} , P_{\max}).

Finally, a check should be made as to whether the motor can generate the torque or the power at the transition speed required by the application (n_n , P_n).

Example:

A power of $P_{\max} = 8$ kW is required at $n_{\max} = 5250$ RPM.

The field weakening range should be 1 : 3.5.

The transition speed, required by the application, would then be $5250/3.5$ RPM = 1500 RPM.

The power-speed diagram indicates, as solution, a motor with e.g. $P_n = 9$ kW, $n_n = 1500$ RPM, $M_n = 57$ Nm.



References

General Documentation

/BU/ Catalog NC 60

Automation Systems for Machine Tools

Ordering document

Order No.: E86060-K4460-A101-A8

Order No.: E86060-K4460-A101-A8-7600 (English)

/DA65/ Catalog DA 65.3

Servomotors for SIMOVERT MASTERDRIVES

Order No.: E86060-K5465-A301-A1

Order No.: E86060-K5465-A301-A1-7600 (English)

/ZI/ Catalog NC Z

SINUMERIK, SIMODRIVE & SIMOVERT MASTERDRIVES

Connection system & system components

Order No.: E86060-K4490-A001-A7

Order No.: E86060-K4490-A001-A7-7600 (English)

Electronic Documentation

/CD1/ DOC ON CD

The SINUMERIK System

(includes all SINUMERIK 840D/810D and SIMODRIVE 611D documents)

Order No.: 6FC5 298-6CA00-0BG4

Manufacturer/Service Documentation

- /PJAS/ Planning Guide, AC Induction Motors**
SIMODRIVE, MASTERDRIVES VC/MC
Contents: General Section, 1PH2, 1PH4, 1PH7 for SIMODRIVE, 1PH7 for
MASTERDRIVES, 1PL6 for MASTERDRIVES
Order No: 6SN1197-0AC61-0BP0
- /ASAL/ Planning Guide, AC Induction Motors**
SIMODRIVE, MASTERDRIVES VC/MC
AC Induction Motors, General Section
Order No: 6SN1197-0AC62-0BP0
- /APH2/ Planning Guide, AC Induction Motors**
SIMODRIVE
AC Induction Motors 1PH2
Order No: 6SN1197-0AC63-0BP0
- /APH4/ Planning Guide, AC Induction Motors**
SIMODRIVE
AC Induction Motors 1PH4
Order No: 6SN1197-0AC64-0BP0
- /APH7S/ Planning Guide, AC Induction Motors**
SIMODRIVE
AC Induction Motors 1PH7
Order No: 6SN1197-0AC65-0BP0
- /APH7M/ Planning Guide, AC Induction Motors**
MASTERDRIVES VC/MC
AC Induction Motors 1PH7
Order No: 6SN1197-0AC66-0BP0
- /APL6/ Planning Guide, AC Induction Motors**
MASTERDRIVES VC/MC
AC Induction Motors 1PL6
Order No: 6SN1197-0AC67-0BP0

- /PJM2/ Planning Guide, AC Servomotors**
SIMODRIVE 611, MASTERDRIVES MC
Contents: General Section, 1FT5, 1FT6, 1FK6, 1FK7
Order No: 6SN1197-0AC20-0BP0
- /PJAL/ Planning Guide, AC Servomotors**
SIMODRIVE 611, MASTERDRIVES MC
AC Servomotors, General Section
Order No: 6SN1197-0AD07-0BP0
- /PFK7/ Planning Guide, AC Servomotors**
SIMODRIVE 611, MASTERDRIVES MC
AC Servomotors 1FK7
Order No: 6SN1197-0AD06-0BP0
- /PFK6/ Planning Guide, AC Servomotors**
SIMODRIVE 611, MASTERDRIVES MC
AC Servomotors 1FK6
Order No: 6SN1197-0AD05-0BP0
- /PFT5/ Planning Guide, AC Servomotors**
SIMODRIVE
AC Servomotors 1FT5
Order No: 6SN1197-0AD01-0BP0
- /PFT6/ Planning Guide, AC Servomotors**
SIMODRIVE 611, MASTERDRIVES MC
AC Servomotors 1FT6
Order No: 6SN1197-0AD02-0BP0
- /PPM/ Planning Guide, Hollow Shaft Motors**
SIMODRIVE
Hollow Shaft Motors for Main Spindle Drives
1PM6 and 1PM4
Order No: 6SN1197-0AD03-0BP0

/PJFE/ Planning Guide, Synchronous Build-in Motors

SIMODRIVE
AC Motors for Main Spindle Drives
Synchronous Build-in Motors 1FE1
Order No: 6SN1197-0AC00-0BP1

/PMS/ Planning Guide, Motor Spindle

SIMODRIVE
ECO Motor Spindle 2SP1
Order No: 6SN1197-0AD04-0BP1

/PJTM/ Planning Guide, Build-in Torque Motors

SIMODRIVE
Build-in Torque Motors 1FW6
Order No: 6SN1197-0AD00-0BP2

/PJLM/ Planning Guide, Linear Motors

SIMODRIVE
1FN1 and 1FN3 Linear Motors
Order No: 6SN1197-0AB70-0BP3

/PJU/ Planning Guide, Drive Converters

SIMODRIVE 611
Drive Converters
Order No: 6SN1197-0AA00-0BP5

/EMV/ Planning Guide, EMC Design Guidelines

SINUMERIK, SIROTEC, SIMODRIVE
Order No: 6FC5297-0AD30-0BP1

Operating Instructions

Operating Instructions 1PH2

Order No.: A1A3433 DE

Operating Instructions 1PH4

Order No.: 610.43.424.21a

Operating Instructions 1PH718□

| | |
|--------------------|--------------|
| Order No.: German | A5E00215737A |
| Order No.: English | A5E00215729A |
| Order No.: Spanish | A5E00215745A |
| Order No.: French | A5E00215713A |
| Order No.: Italian | A5E00215741A |
| Order No.: Swedish | A5E00215747A |

Operating Instructions 1PH722□, available from 02.2004

| | |
|--------------------|--------------|
| Order No.: German | A5E00264361A |
| Order No.: English | A5E00264369A |
| Order No.: Spanish | A5E00264372A |
| Order No.: French | A5E00264534A |
| Order No.: Italian | A5E00264543A |
| Order No.: Swedish | A5E00264554A |

Operating Instructions 1PH728□

| | |
|--------------------|--------------|
| Order No.: German | A5E00171047A |
| Order No.: English | A5E00177602A |
| Order No.: Spanish | A5E00205680A |
| Order No.: French | A5E00205665A |
| Order No.: Italian | A5E00205677A |
| Order No.: Swedish | A5E00205684A |

Operating Instructions 1PL618□

| | |
|--------------------|--------------|
| Order No.: German | A5E00215739A |
| Order No.: English | A5E00215731A |
| Order No.: Spanish | A5E00215746A |
| Order No.: French | A5E00215726A |
| Order No.: Italian | A5E00215743A |
| Order No.: Swedish | A5E00215748A |

Operating Instructions 1PL622□, available from 02.2004

| | |
|--------------------|--------------|
| Order No.: German | A5E00264364A |
| Order No.: English | A5E00264365A |
| Order No.: Spanish | A5E00264370A |
| Order No.: French | A5E00264374A |
| Order No.: Italian | A5E00264537A |
| Order No.: Swedish | A5E00264546A |

Operating Instructions 1PL628□

| | |
|--------------------|--------------|
| Order No.: German | A5E00171048A |
| Order No.: English | A5E00177606A |
| Order No.: Spanish | A5E00205686A |
| Order No.: French | A5E00205688A |
| Order No.: Italian | A5E00205687A |
| Order No.: Swedish | A5E00205693A |



Index

A

Axial eccentricity tolerance, AL/2-26
Axial force, AL/2-33

B

Balancing process, AL/2-23
Bearing change intervals, AL/2-34
Bearing lifetime, AL/2-34

C

Cantilever force, AL/2-31
Commissioning software, AL/4-39
Concentricity tolerance, AL/2-26
Connecting-up information, AL/3-37
Core types, AL/1-14

D

Danger and warning information, AL/vii
Degree of protection, AL/2-28
Drive converter systems, AL/1-17
Drive-out transmission shaft, AL/2-25

E

Engineering information, AL/4-39
Engineering software, AL/4-39
Equalization coupling, AL/2-25
ESDS instructions, AL/x
Externally excited vibrations, AL/2-24

F

Flywheels, AL/2-25

H

Hotline, AL/vi

I

Induction motors
Mode of operation, AL/1-15
Selecting and determining, AL/4-40

M

Maximum continuous speed, AL/1-13
Maximum torque, AL/1-13
Mechanical limit speed, AL/1-13
Mechanical limiting, AL/1-19
Misalignment errors, AL/2-25
Motor selection, AL/4-39

N

Natural frequency when mounted, AL/2-24
NCSD configurator, AL/4-39

O

Operation on, SIMODRIVE 611, AL/1-17
Operation with, SIMOVERT MASTERDRIVES,
AL/1-18

P

Power characteristics, AL/1-16
Power module, AL/1-19
Power-speed diagram, AL/1-16

R

Radial eccentricity, AL/2-26

S

S1 duty, AL/1-13
S6 duty, AL/1-14
Signal cable, AL/3-38

SIMODRIVE 611, AL/1-17
SIMOVERT MASTERDRIVES, AL/1-18
Speed n1, AL/1-13

T

Thermal limiting, AL/1-19

Thermal time constant, AL/1-14
Types of construction, AL/2-21

V

Vibration severity limit values, AL/2-21

To
SIEMENS AG
A&D MC BMS
Postfach 3180
D-91050 Erlangen

Tel.: +49 (0)180 / 5050 – 222 [Service Support]
Fax: +49 (0)9131 / 98 – 2176 [Documentation]
email: motioncontrol.docu@erlf.siemens.de

| | |
|---|--|
| From Name _____ Company address/Dept. _____ Street _____ Postal code: City: _____ Telephone: / _____ Telefax: / _____ | Recommendations |
| | Corrections For documentation: AC Induction Motors General Section Manufacturer/Service Documentation |
| | Planning Guide Order No.: 6SN1197-0AC62-0BP0 Edition: 10.2003 |
| | If you come across any printing errors in this document, please let us know using this form. We would also be grateful for any recommendations and suggestions. |

Recommendations and/or corrections

Documentation overview SIMODRIVE

General Documentation

Manufacturer/Service Documentation

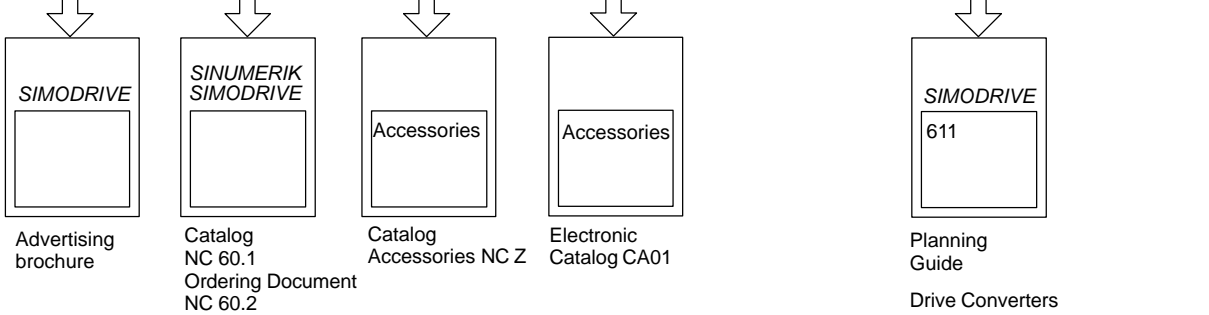

Manufacturer/Service Documentation

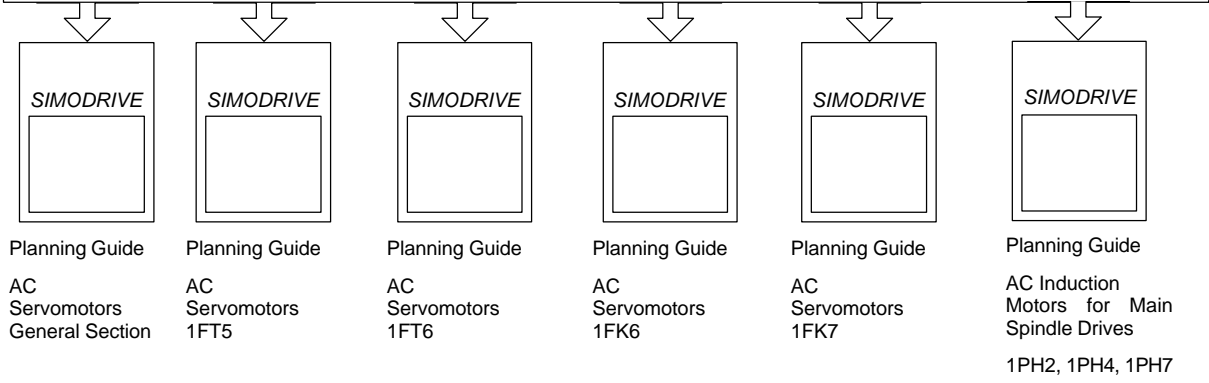

Manufacturer/Service Documentation

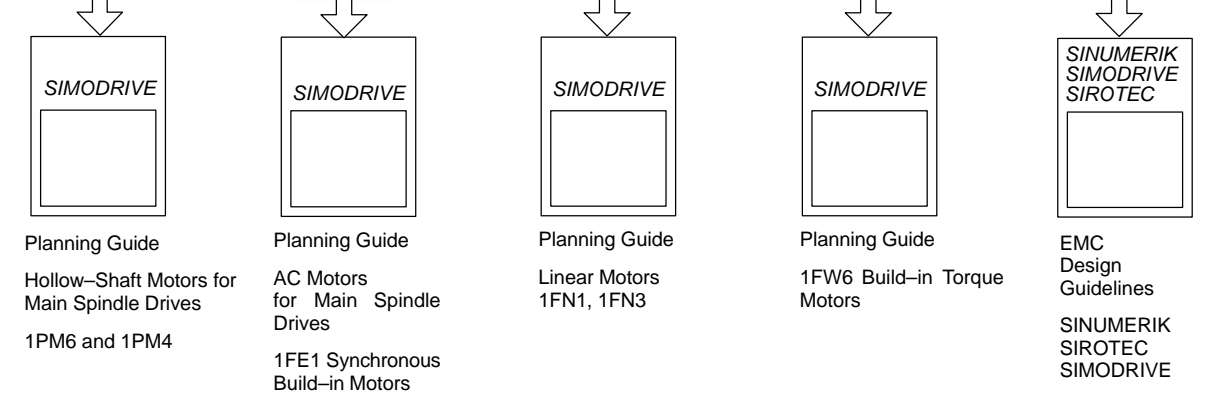

Electronic Documentation

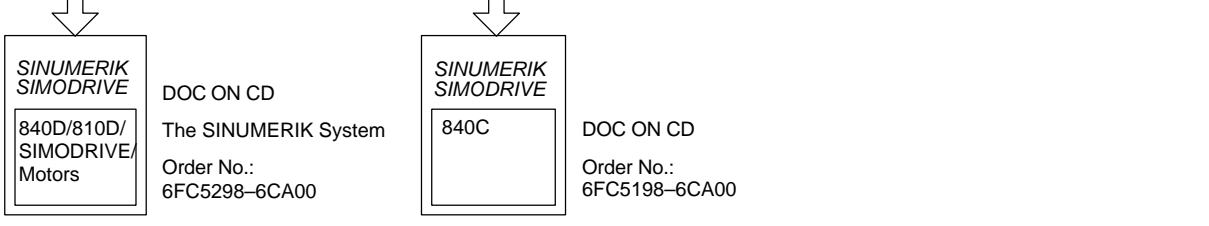

Siemens AG

Automatisierungs- und Antriebstechnik

Motion Control Systems

Postfach 3180, D – 91050 Erlangen

Bundesrepublik Deutschland

www.ad.siemens.de

© Siemens AG 2003
Subject to change without prior notice
Order No.: 6SN1197-0AC62-0BP0

Printed in the Federal Republic of Germany