



HEIDENHAIN



Service Manual

Data Interfaces for HEIDENHAIN Controls of the Series

TNC 122	TNC 351/355
TNC 124	TNC 360
TNC 125	TNC 370
TNC 131/135	TNC 406
TNC 145	TNC 407/415
TNC 150/151/155	TNC 410
TNC 246	TNC 425
TNC 2500	TNC 426/430
TNC 306	CNC 232 B
TNC 310	CNC 234.xx
TNC 335	CNC 332

July 2011

1	How to Use this Service Manual	
1.1	Target Group	5
1.2	About this Manual	5
1.3	Other Documentation on Data Interfaces	5
1.4	Meaning of the symbols used in this manual	6
2	General Information on the Data Interfaces	
2.1	RS-232-C/V.24 Interface	7
2.1.1	Hardware.....	7
2.1.2	Signal levels	7
2.1.3	HEIDENHAIN data transfer software	8
2.2	RS-422/V.11 Interface	9
2.2.1	Hardware.....	9
2.2.2	Signal levels	10
2.2.3	HEIDENHAIN data transfer software	10
2.3	Ethernet	10
2.3.1	Hardware.....	11
2.3.2	Signal structure	11
2.3.3	Connecting the TNC to data networks.....	12
3	Connector Designations and Layouts	
3.1	Connector Designations and Layouts of TNC 125, 131, 135, 145, 150, 151/155	13
3.2	Connector Designations and Layouts of TNC 122, TNC 2xx, TNC 3xx, TNC 4xx, CNC xxx	14
3.2.1	RS-232-C/V.24 data interface, 25-pin, D-sub Flange socket with female insert.....	14
3.2.2	RS-232-C/V.24 data interface, 9-pin, D-sub Flange socket with female insert.....	15
3.2.3	RS-422/V.11 data interface, 15-pin, D-sub Flange socket with female insert.....	16
4	Wiring Diagrams of the Data Interfaces	
4.1	RS-232-C/V.24 Overview	19
4.2	RS-422/V.11 Overview	20
4.3	Ethernet Overview	20
4.4	RS-232-C/V.24 Diagrams	20
4.5	RS-422/V.11 Diagram	33
4.6	V.11 -> V.24 Converter	33
5	Operating Modes of the Data Interfaces	
5.1	Operating Modes on TNC 125, 131, 135, 145, 150, 151/155	35
5.2	Operating Modes on TNC 122 to TNC 430	36
6	Machine Parameters for the Data Interfaces	
6.1	Machine Parameters for TNC 125, 131, 135, 145, 150, 151/155, 351/355	39
6.1.1	Overview.....	39
6.1.2	Description of the machine parameters.....	40
6.2	Machine Parameters for for TNC 122/124	48
6.2.1	Overview.....	48
6.2.2	Description of the machine parameters.....	48

6.3	Machine Parameters for TNC 232/246	49
6.3.1	Overview	49
6.3.2	Description of the machine parameters	50
6.4	Machine Parameters for TNC 306/335/360/2500/CNC 234/TNC 370	51
6.4.1	Overview	51
6.4.2	Description of the machine parameters	52
6.5	Machine Parameters for TNC 310/410	54
6.5.1	Overview	54
6.5.2	Description of the machine parameters	55
6.6	Machine Parameters for TNC 406/407/415/425	56
6.6.1	Overview	56
6.6.2	Description of the machine parameters of TNC 406/407/415	57
6.6.3	Description of the machine parameters of TNC 415 B/425	60
6.7	Machine Parameters for TNC 426/430	63
6.7.1	Overview	63
6.7.2	Description of the machine parameters	64
7	Ethernet Card (Option) in TNC 426/430 Controls	
7.1	Installing the Ethernet Card	65
7.2	Connecting the Ethernet Hardware	66
7.3	Ethernet Configuration in the TNC	68
7.3.1	Settings in DEFINE NET	68
7.3.2	Settings in DEFINE MOUNT	72
7.4	Checking the Connection to the Server	79
7.5	Finding the Hardware Address of the Ethernet Card	80
7.6	Working with the Ethernet Interface	81
7.6.1	Establish network connection (mount)	81
7.6.2	Unmounting a network connection	83
8	Error Messages and their Causes	
8.1	Error Messages Related to the RS-232C and RS-422 Interfaces	85
8.1.1	Error messages at the TNC in the ME mode	85
8.1.2	Error messages at the ME	86
8.1.3	Error messages at the FE in the ME mode	87
8.1.4	Error messages at the TNC in the FE mode	89
8.1.5	Error messages during data transfer	90
8.2	Ethernet Error Messages	91
9	Tables	
9.1	7-Bit ASCII Code	93
9.2	Powers of 2	97

1 How to Use this Service Manual

1.1 Target Group

This Service Manual has been written for **specialist electricians** for service, maintenance and commissioning as well as for end users of machine tools with HEIDENHAIN controls.

1.2 About this Manual

This manual provides support for connecting, machine parameter setting and troubleshooting the data interfaces RS-232-C, RS-422 and Ethernet of the following HEIDENHAIN controls.

- TNC 122
- TNC 124
- TNC 125
- TNC 131/135
- TNC 145
- TNC 150/151/155
- TNC 246
- TNC 2500
- TNC 306
- TNC 310
- TNC 335
- TNC 351/355
- TNC 360
- TNC 370
- TNC 406
- TNC 407/415
- TNC 410
- TNC 425
- TNC 426/430
- CNC 232B
- CNC 234.xx
- CNC 332

1.3 Other Documentation on Data Interfaces

For information on the data interfaces of the HEIDENHAIN controls as of iTNC 530, TNC 320, TNC 620, etc., please refer to the respective Technical Manual, User's Manual and Service Manual.

1.4 Meaning of the symbols used in this manual



DANGER

Failure to comply with this information could result in most serious or fatal injuries, and/or in substantial material damage.



Attention

Failure to comply with this information could result in injuries and interruptions of operation, including material damage.



Note

These boxes contain important and useful information.

2 General Information on the Data Interfaces

2.1 RS-232-C/V.24 Interface

RS-232-C is the designation of a serial interface for transfer rates of up to 19,200 bps based on the American EIA standard of the same name. Data transfer is executed asynchronously, with a start bit before each character and one or two stop bits after each character.

The interface is designed for transmission distances of up to 30 meters.

The RS-232-C interface has been adopted with slight modifications and introduced into Europe as the V.24 interface. The relevant German standard is DIN 66020.

2.1.1 Hardware

The physical connection between two RS-232-C/V.24 interfaces is an asymmetrical line, i.e. the common ground connection between transmitter and receiver is used as a return wire.

Physical connections:

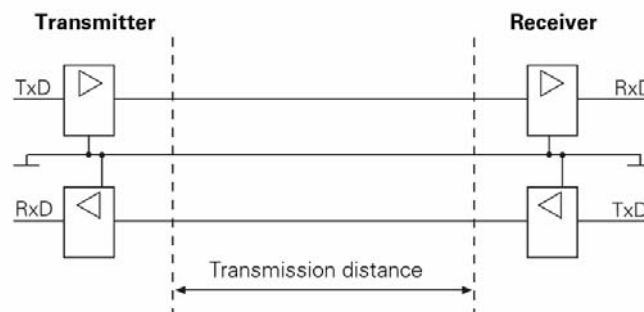

2.1.2 Signal levels

With the RS-232-C/V.24 interface one must differentiate between two different signal lines and their levels.

Data lines:

The data signals are defined as being logical one (MARK) over the range -3 V to $+15\text{ V}$ and logical zero (SPACE) over the range $+3\text{ V}$ to $+15\text{ V}$.

Control and signal lines:

These signals are defined as being ON (High) over the range $+3\text{ V}$ to $+15\text{ V}$ and as OFF (Low) over the range -3 V to -15 V .

For all of the signals, the voltage range from -3 V to $+3\text{ V}$ is not defined as a logic level and can therefore not be evaluated.

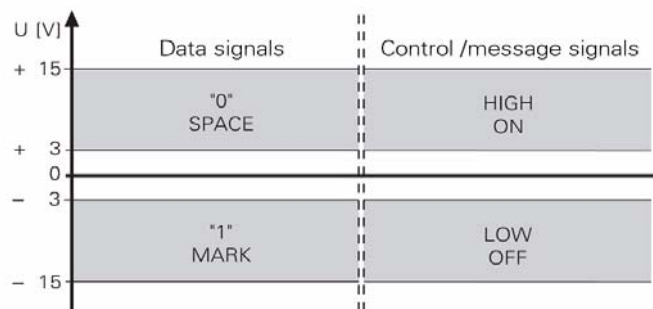

2.1.3 HEIDENHAIN data transfer software

TNCremoNT is a software package for communication between PCs and HEIDENHAIN controls or programming stations.

Data transfer is carried out over the Ethernet network or the serial interface.

TNCremoNT can be run on all common personal computers.

A version of Windows 2000, XP, Vista or 7 must be used as operating system.

Windows 2000, Windows XP, Windows Vista and Windows 7 are registered trademarks of the Microsoft Corporation.

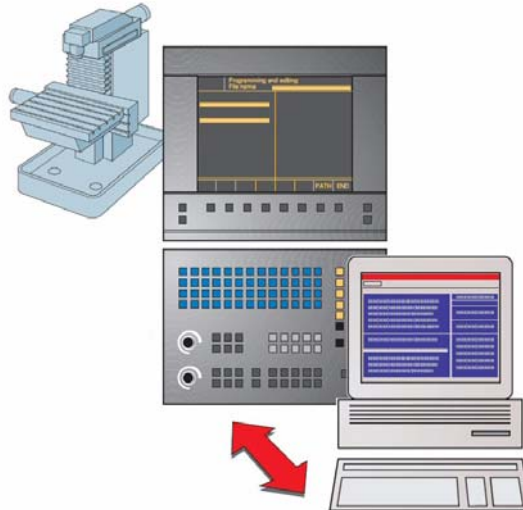

The TNCremoNT software package includes:

Functions of TNCremoNT

TNCremoNT

- Convenient data transfer and management functions that are operated from the PC
- Screenshot of the control's screen
- Read-out of the control's log
- Pallet management for creating, editing and transmitting pallet tables
- Creating a service file

TNCserver

- Transfer via the serial interface with operation on the control for all HEIDENHAIN controls and many HEIDENHAIN position displays.
- Support of all HEIDENHAIN protocols including simple data input/output.

TNCbackup

- Features for data backup and restoration

TNCcmd

- Command line tool for all transfer functions

TNClog

- Log viewer to view and filter the control's log file

TNCremoPlus (available for a fee)

- View control screen (live screen)

The selection of features you can use in TNCremoNT depends on your control. Refer to the overview of features for more detailed information.

2.2 RS-422/V.11 Interface

As the features of the V.24/RS-232-C interface are limited, the V.11/RS-422 interface was developed. This interface is also standardized, but operates symmetrically. The RS-422/V.11 serial interface is suitable for data transfer rates up to 10 Mbps. At a baud rate of 38,400 bauds, data can be transferred over 1 km cable.

2.2.1 Hardware

The V.11/RS-422 standard operates with differential voltages. This offers the advantage that interferences act on both signal lines equally and simultaneously over the transmission distance. As the receiver only evaluates the differential voltages of the two signal lines, interferences are not relevant. By this means, considerably longer lines can be installed, and the transfer rate is much higher, as interferences are limited.

Physical connections:

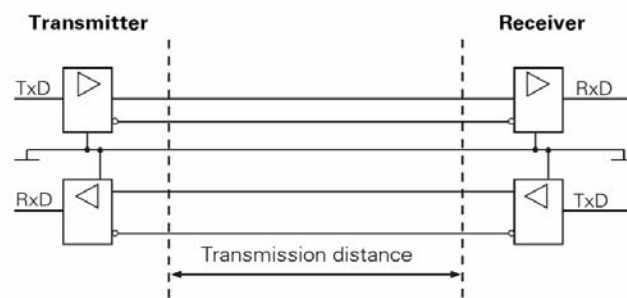

2.2.2 Signal levels

With the V.11/RS-422 interface the signals are both transmitted and received as differential voltage.

A positive differential voltage means a logical zero (OFF), a negative differential voltage means a logical one (ON).

Differential voltages between

$U_{dmin} = 2 \text{ V}$ and $U_{dmax} = 5 \text{ V}$ are output; the control detects the differential voltages between

$U_{dmin} = 0.2 \text{ V}$ and $U_{dmax} = 6 \text{ V}$ as logically defined levels.

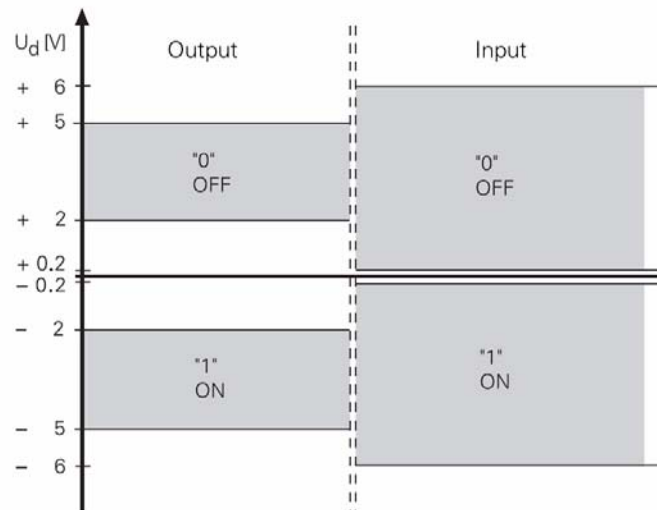

2.2.3 HEIDENHAIN data transfer software

See chapter 2.1.3

2.3 Ethernet

Ethernet technology is most frequently used in local networks. It was developed by Digital Equipment, Intel and Xerox in 1982. Ethernet operates at a data transfer rate of up to 100 Mbps (Fast Ethernet); the hardware versions most frequently used - such as 10Base2 (Thin Ethernet, Cheapernet), 10Base5 (Thick Ethernet, Yellow Cable) or 10BaseT (Twisted Pair) - operate at 10 Mbps. They differ in price, routing complexity or network topology, but not in the method of accessing media.

The data transfer rate strongly depends on the amount of traffic at the time on the net.

Realistic values: NC program up to 200 Kbps
 ASCII file up to 1 Mbps

2.3.1 Hardware

The integrated Ethernet expansion card provides you with both the 10Base2 (BNC) port and the 10BaseT (twisted pair). You can only use one of the two connections at one time. Both connections are electrically isolated from the control electronics.

Connection and wiring diagrams see chapter 7.2, pin layouts see chapter 3.2.

X26 Ethernet interface, BNC connection (coaxial cable, 10Base2)

The 10Base2 connection is also commonly known as **ThinEthernet** or **CheaperNet**. You connect the TNC with your network via BNC-T connector. The maximum cable length is 185 m (coaxial cable). The network topology is a linear bus. The "open" ends of the bus must be terminated with terminating resistors.

X25 Ethernet interface, RJ45 connection (10BaseT)

The twisted-pair cable of the 10BaseT connector may be either shielded or non-shielded.

Maximum cable length:	non-shielded:	100 m
	shielded:	400 m

The network topology is a star connection. This means a central node establishes the connection to the other participants.

2.3.2 Signal structure

Ethernet frames are transferred in **Manchester code** which is a self-clocking code. The synchronization or the transfer of a transmit clock pulse is executed such that each bit is transmitted inverted in the first half of the transfer period, i.e. the bit rate is half the baud rate. A data rate of 10 Mbps results in a bit time of 100 ns. Carrier detect (activity on the cable) is indicated by the presence of signal level changes. If the signal level does not change in a bit time interval between 0.75 and 1.25 after the last transition, no carrier is detected (see figure).

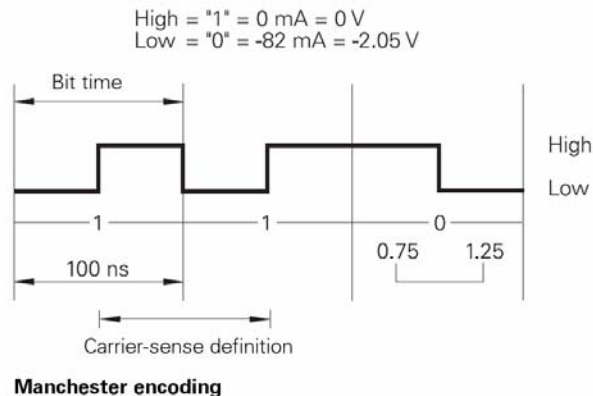

The network settings of the TNC are described in the Technical Manual and in chapter 7 (Ethernet) of this Service Manual.

2.3.3 Connecting the TNC to data networks

The HEIDENHAIN control models TNC 426/TNC 430 can optionally¹⁾ be equipped with an Ethernet data interface. Via this interface, TNC 426/TNC 430 can be integrated into data networks as client.

The TNC transfers data using the TCP/IP protocol (Transmission Control Protocol / Internet Protocol) and with the aid of the NFS, version 2 (Network File System). Since TCP/IP and NFS have been implemented in UNIX systems in the first place, you can usually connect the TNC in the UNIX world without any additional software.

The PC world with Microsoft operating systems, however, also works with TCP/IP, but not with NFS. For this reason, additional software is usually required for PC networks. HEIDENHAIN recommends the following network software:

Operating system	Network Software
WIN 2000 WIN XP WIN Vista WIN 7	CIMCO NFS available from HEIDENHAIN under ID 339737-xx



Note

In principle, other NFS servers can be used as well.
However, due to the great variety of software providers, HEIDENHAIN is not in a position to provide technical support in adapting other NFS servers.

¹⁾ Control models that can be operated with the Ethernet card: see chapter 2.
The network settings of the TNC are described in the Technical Manual and in chapter 7 (Ethernet) of this Service Manual.

3 Connector Designations and Layouts

3.1 Connector Designations and Layouts of TNC 125, 131, 135, 145, 150, 151/155

RS-232-C/V.24 data interface, 14-pin, Amphenol

Flange socket with female insert

	Pin no.	Assignment	Designation
	1	GND	Chassis ground
	2	Not assigned	
	3	Not assigned	
	4	Not assigned	
	5	RTS	Request to Send
	6	DSR	Data Set Ready
	7	Not assigned	
	8	Not assigned	
	9	Not assigned	
	10	Not assigned	
	11	DTR	Data Terminal Ready
	12	TxD	Transmit Data
	13	CTS	Clear to Send
	14	RXD	Receive Data
Chassis	Ext. shield		

3.2 Connector Designations and Layouts of TNC 122, TNC 2xx, TNC 3xx, TNC 4xx, CNC xxx

3.2.1 RS-232-C/V.24 data interface, 25-pin, D-sub

Flange socket with female insert

Pin no.	Assignment	Designation
1	Shield	Chassis Ground
2	RxD	Receive Data
3	TxD	Transmit Data
4	CTS	Clear to Send
5	RTS	Request to Send
6	DTR	Data Terminal Ready
7	GND (0 V *2)	Signal Ground
8 to 19	Not assigned	
20	DSR	Data Set Ready
21 to 25	Not assigned	
Chassis	External shield = Chassis	

Control model	RS-232-C/V.24 connector			
	X21	X25	X6	X26
TNC 122	x			
TNC 246			x	
TNC 2500/B/C		x		
TNC 306		x		
TNC 335		x		
TNC 351/355				x
TNC 360		x		
TNC 406	x			
TNC 407	x			
TNC 410	x			
TNC 415/B	x			
TNC 425	x			
TNC 426	x			
TNC 430	x			
CNC 232B			x	
CNC 234.xxx		x		
CNC 332				x

3.2.2 RS-232-C/V.24 data interface, 9-pin, D-sub

Flange socket with female insert

Pin no.	Assignment	Designation
1	Shield	Chassis Ground
2	TxD	Transmit Data
3	RxD	Receive Data
4	DSR	Data Set Ready
5	GND	Signal Ground
6	DTR	Data Terminal Ready
7	CTS	Clear to Send
8	RTS	Request to Send
9	Not assigned	
Chassis	External shield = Chassis	

Control model	RS-232-C/V.24 connector			
	X21			
TNC 124	x			
TNC 310	x			
TNC 370	x			

3.2.3 RS-422/V.11 data interface, 15-pin, D-sub

Flange socket with female insert

Pin no.	Assignment	Designation
1	Shield	Chassis Ground
2	RxD	Receive Data
3	CTS	Clear to Send
4	TxD	Transmit Data
5	RTS	Request to Send
6	DSR	Data Set Ready
7	DTR	Data Terminal Ready
8	GND	Signal Ground
9	RxD	Receive Data
10	CTS	Clear to Send
11	TxD	Transmit Data
12	RTS	Request to Send
13	DSR	Data Set Ready
14	DTR	Data Terminal Ready
15	Do not assign	

Control model	RS-422/V.11 connector			
	X22			
TNC 406	x			
TNC 407	x			
TNC 415/B	x			
TNC 425	x			
TNC 426	x			
TNC 430	x			

X25 Ethernet interface, RJ45 connection, 10BaseT

Maximum cable length: non-shielded: 100 m
shielded: 400 m

RJ45 connection (female) 8-pin	Assignment
1	TX+
2	TX-
3	REC+
4	Not assigned
5	Not assigned
6	REC-
7	Not assigned
8	Not assigned

X26 Ethernet interface, BNC connection, 10Base2 (coaxial cable)

Maximum cable length: 180 m

BNC connection (female)	Assignment
Inner conductor (core)	Data (RXI, TXD)
Shield	GND

Control model	Ethernet connector (option)	
	X25	X26
TNC 426.B	x	x
TNC 430.A	x	x
TNC 426M/430M	x	x

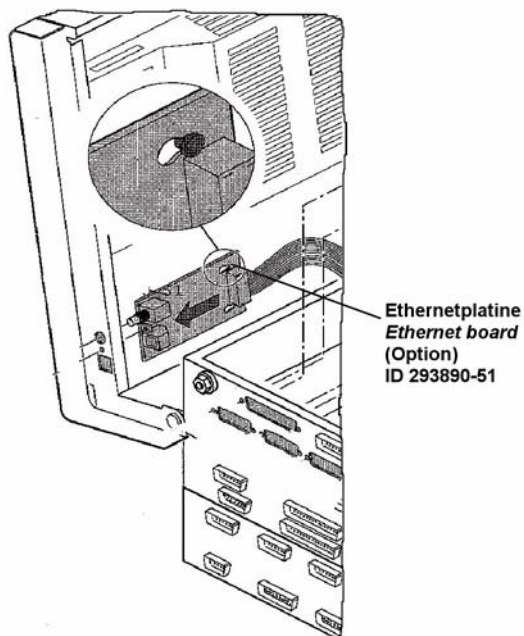

4 Wiring Diagrams of the Data Interfaces

4.1 RS-232-C/V.24 Overview

Control	Connection of peripheral, 25-pin				Connection of peripheral, 9-pin			
	Wiring diagram for connection				Wiring diagram for connection			
	direct		via adapter and JH cable		direct		via adapter and JH cable	
	HW	SW	HW	SW	HW	SW	HW	SW
TNC 122	11	12	2	1	10	10	3	4
TNC 124	-	-	14	14	-	-	15	15
TNC 125	13	13	7	8	9	9	5	6
TNC 131	13	13	7	8	9	9	5	6
TNC 135	13	13	7	8	9	9	5	6
TNC 145	13	13	7	8	9	9	5	6
TNC 150	13	13	7	8	9	9	5	6
TNC 151/155	13	13	7	8	9	9	5	6
TNC 246	11	12	2	1	10	10	3	4
TNC 2500/B/C	11	12	2	1	10	10	3	4
TNC 306	11	12	2	1	10	10	3	4
TNC 310	-	-	14	14	-	-	15	15
TNC 335	11	12	2	1	10	10	3	4
TNC 351/355	11	12	2	1	10	10	3	4
TNC 360	11	12	2	1	10	10	3	4
TNC 370	-	-	14	14	10	10	15	15
TNC 406	11	12	2	1	10	10	3	4
TNC 407	11	12	2	1	10	10	3	4
TNC 410	11	12	2	1	10	10	3	4
TNC 415/B	11	12	2	1	10	10	3	4
TNC 425	11	12	2	1	10	10	3	4
TNC 426	11	12	2	1	10	10	3	4
TNC 430	11	12	2	1	10	10	3	4
CNC 232B	11	12	2	1	10	10	3	4
CNC 234.XXX	11	12	2	1	10	10	3	4
CNC 332	11	12	2	1	10	10	3	4

HW: Wiring diagram for data transfer with hardware handshake

SW: Wiring diagram for data transfer with software handshake

4.2 RS-422/V.11 Overview

Control model	Connection diagram
TNC 406	16
TNC 407	16
TNC 415/B	16
TNC 425	16
TNC 426	16
TNC 430	16
V.11 -> V.24 converter	17

4.3 Ethernet Overview

Control model	Connection diagram
TNC 426	Chapter 7.2
TNC 430	Chapter 7.2

4.4 RS-232-C/V.24 Diagrams

Diagram no. 1
RS-232-C/V.24 with adapter block for software handshake,
TNC 25-pin / peripheral 25-pin

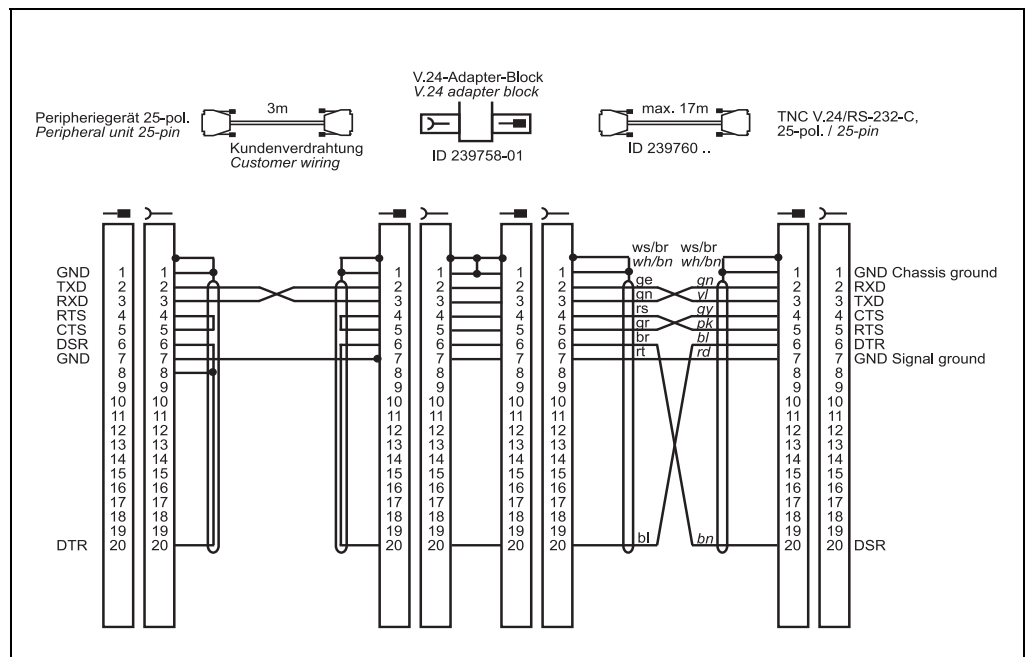

Note

This wiring only allows transfer stop with DC3 (software handshake).

The RS-232-C-/V.24 data interface has different pin layouts at the logic unit and the V.24 adapter block.

Diagram no. 2
RS-232-C/V.24 with adapter block for hardware handshake,
TNC 25-pin / peripheral 25-pin

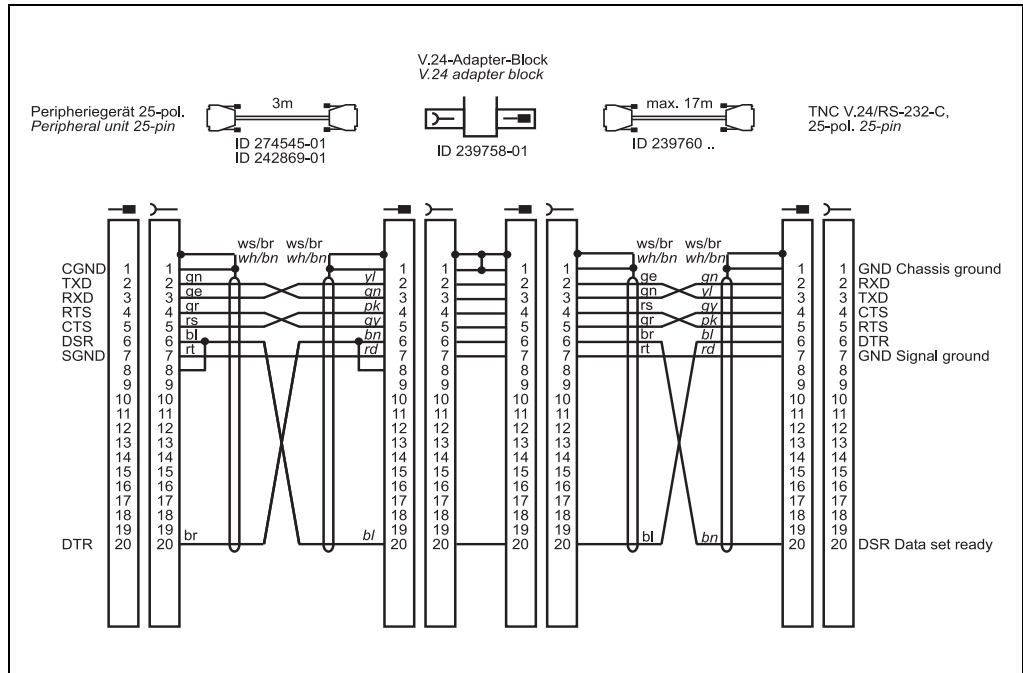

Note

If the pin layout of your peripheral unit differs from the above layout, the HEIDENHAIN connecting cable cannot be used.

Diagram no. 3
RS-232-C/V.24 with adapter block for hardware handshake,
TNC 25-pin / peripheral 9-pin

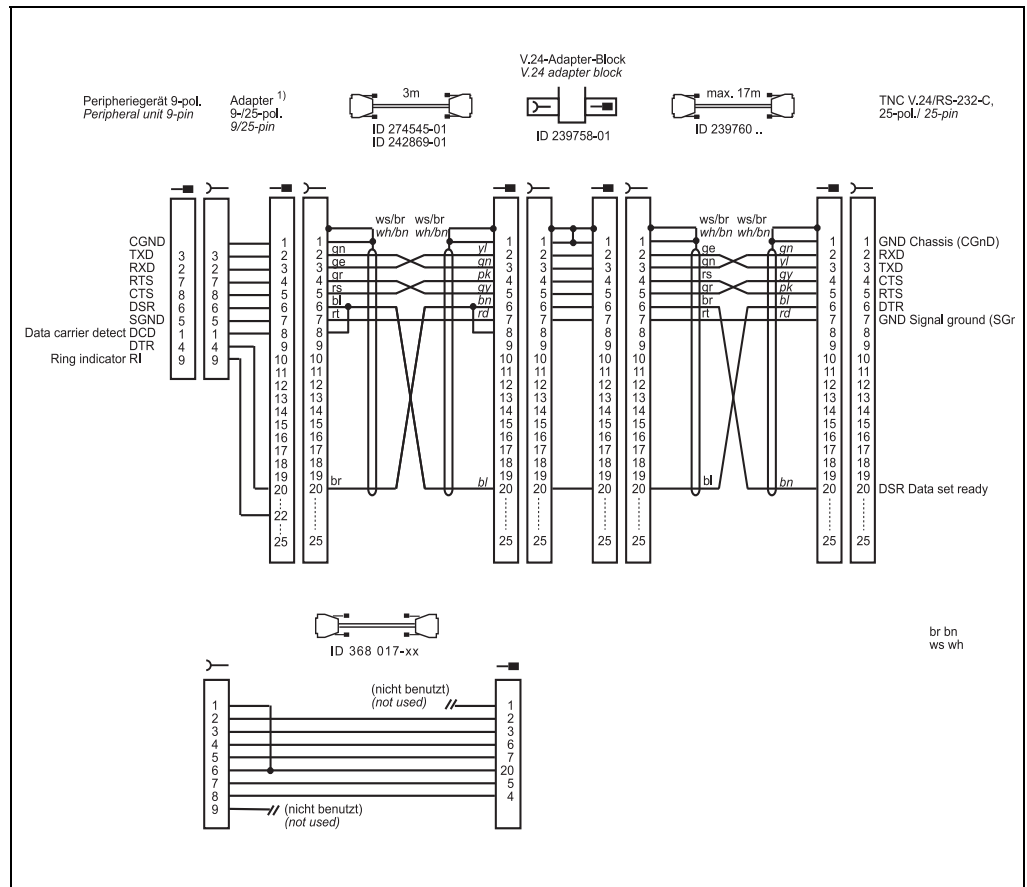

1) Customer wiring or part available on market

Diagram no. 4
RS-232-C/V.24 with adapter block for software handshake,
TNC 25-pin / peripheral 9-pin

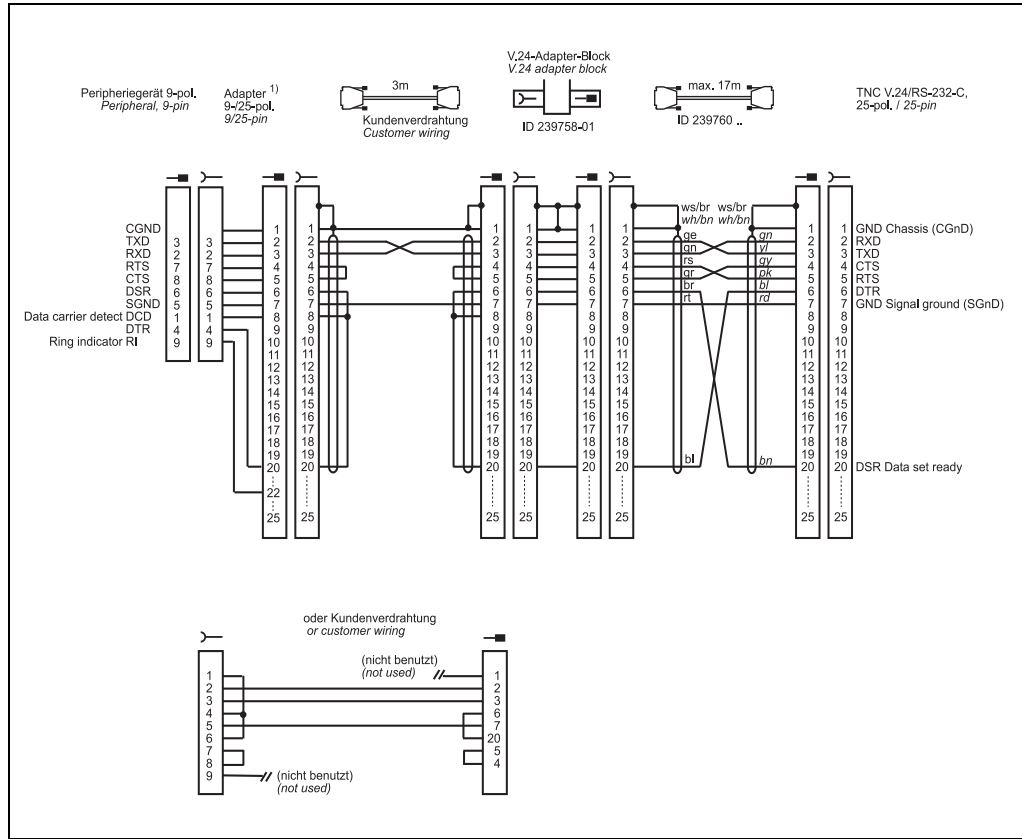

1) Customer wiring or part available on market

Diagram no. 5
RS-232-C/V.24 with adapter block for software handshake,
TNC 25-pin / peripheral 9-pin

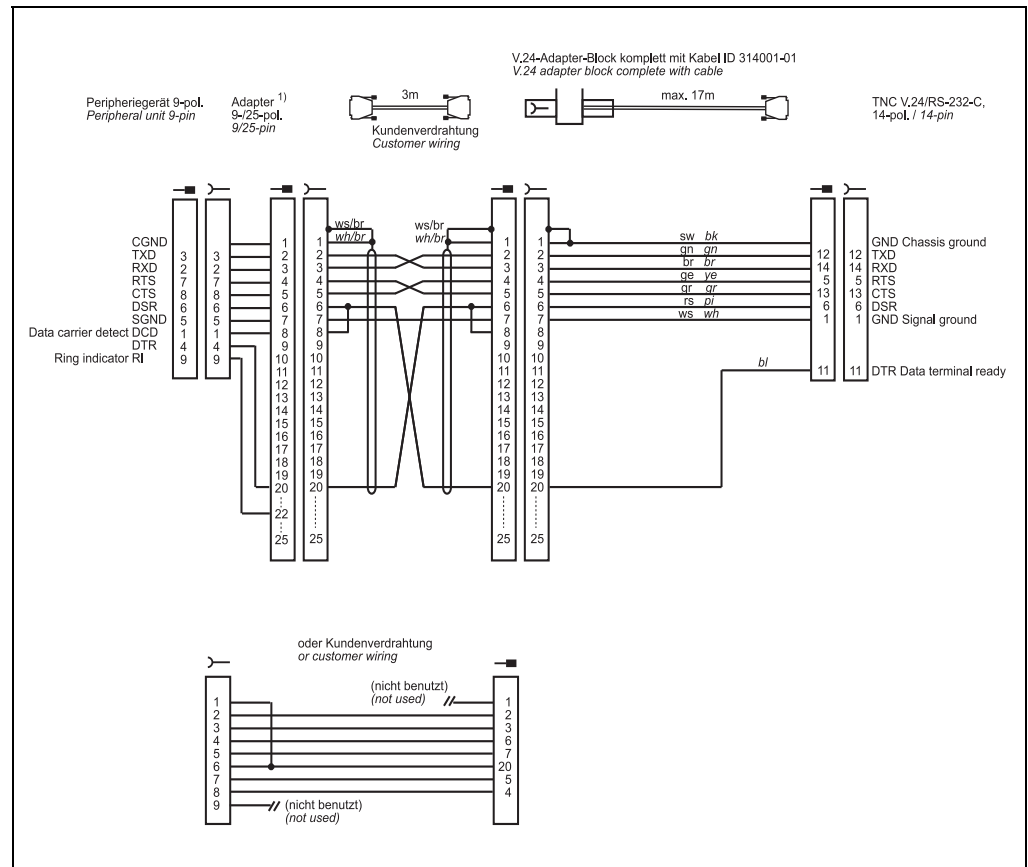

1) Customer wiring or part available on market



Attention

This modification applies for hardware handshake with TNC 145 to TNC 155. In these control models, the RTS pin is not connected but tied high internally.

The following modification is required for hardware handshake:
Cut the line on both sides between DRS and DTR and short-circuit DSR with DTR
(at the PC: pin 6 with pin 20).

Without this modification, data transfer using hardware handshake is not only stopped but aborted immediately (like "power off).

Do not use this configuration for TNC 335 with new hardware.

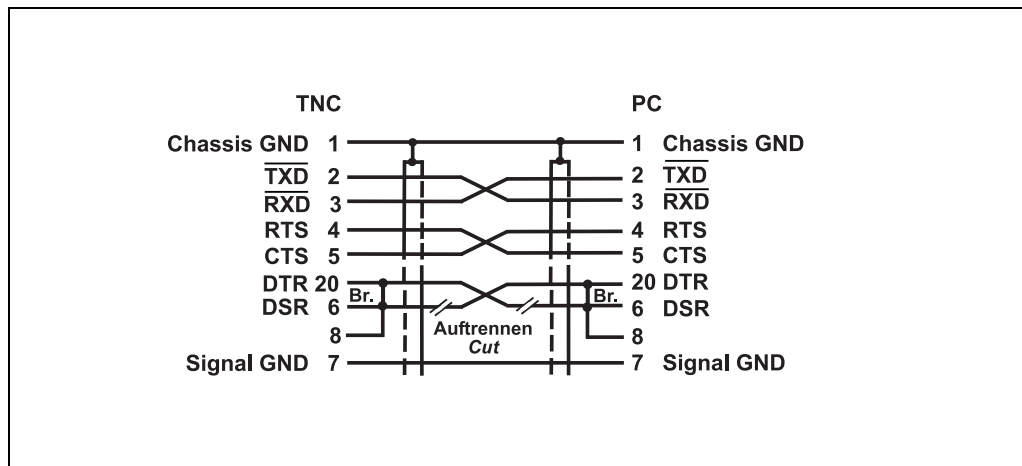
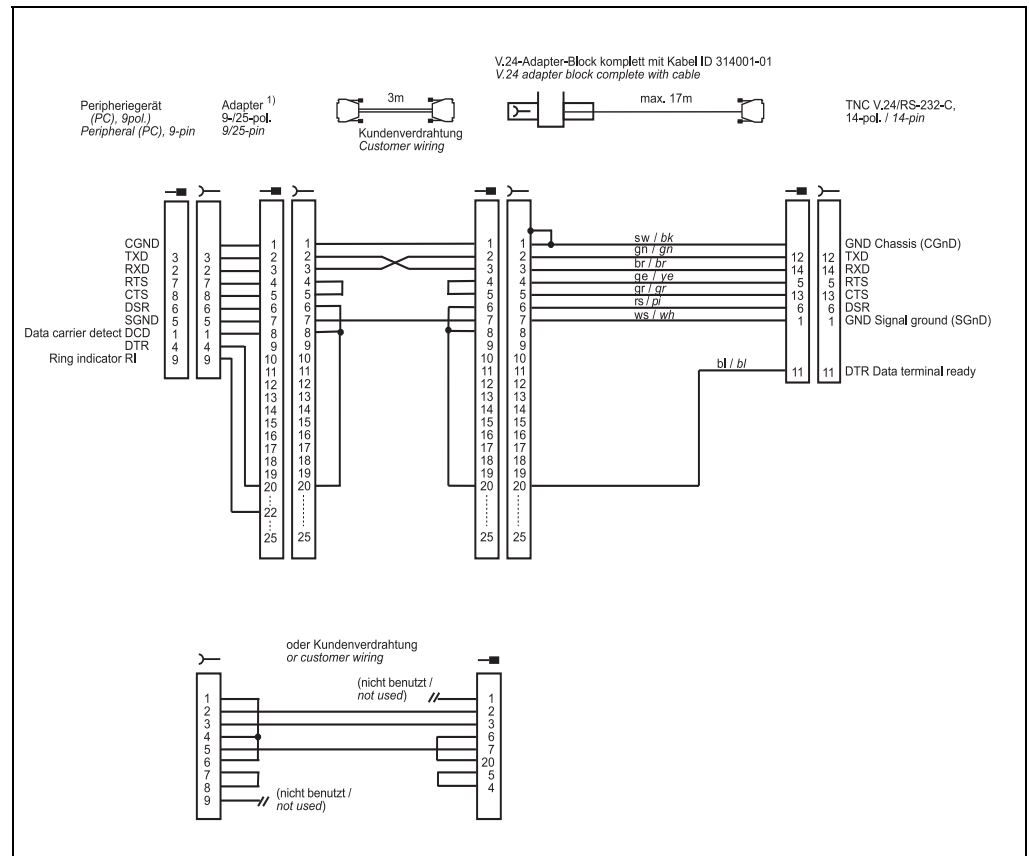
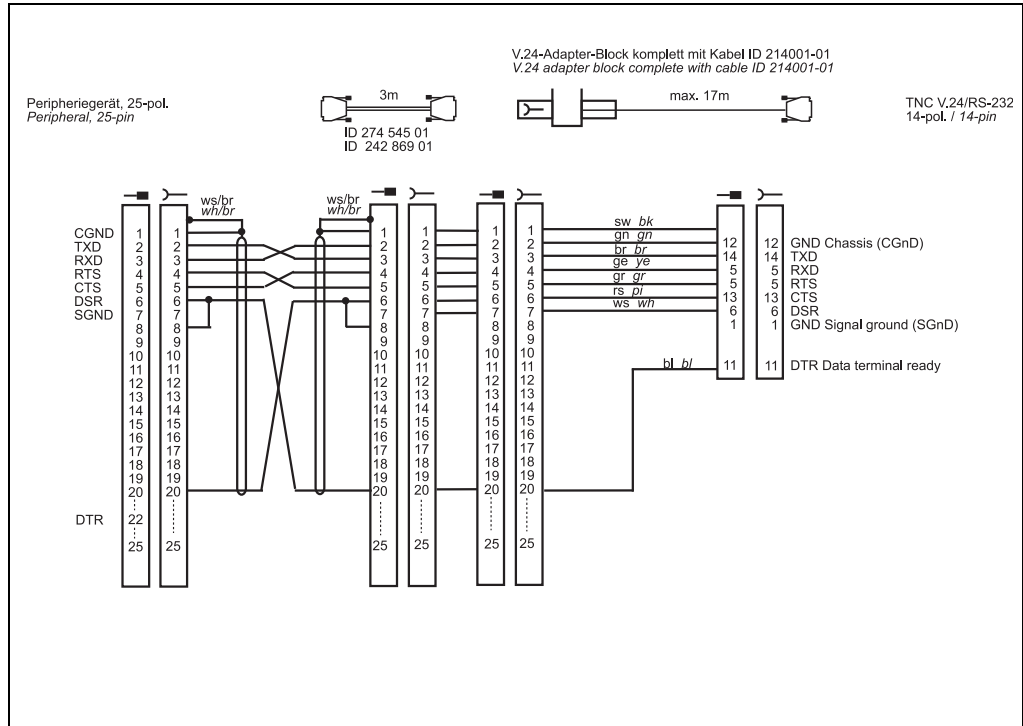

Diagram no. 6
RS-232-C/V.24 with adapter block for software handshake,
TNC 14-pin / peripheral 9-pin



¹⁾ Customer wiring or part available on market

Diagram no. 7
RS-232-C/V.24 with adapter block for hardware handshake,
TNC 14-pin / peripheral 25-pin





Attention

This modification applies for hardware handshake with TNC 145 to TNC 155. In these control models, the RTS pin is not connected but tied high internally.

The following modification is required for hardware handshake:
Cut the line on both sides between DRS and DTR and short-circuit DSR with DTR
(at the PC: pin 6 with pin 20).

Without this modification, data transfer using hardware handshake is not only stopped but aborted immediately (like "power off").

Do not use this configuration for TNC 335 with new hardware.

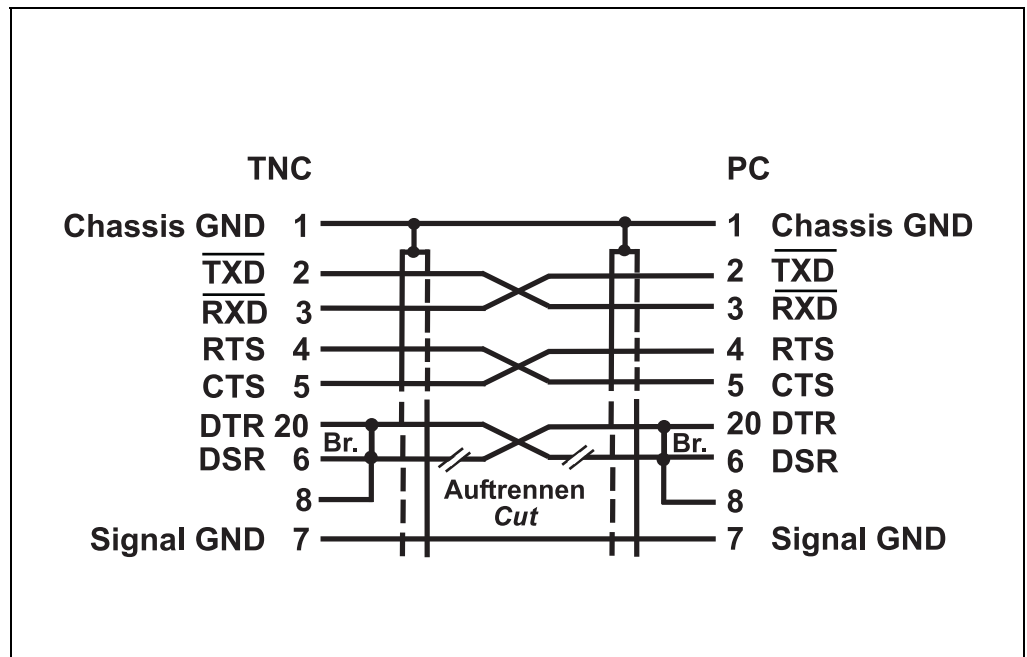

Diagram no. 8
RS-232-C/V.24 with adapter block for software handshake,
TNC 14-pin / peripheral 25-pin

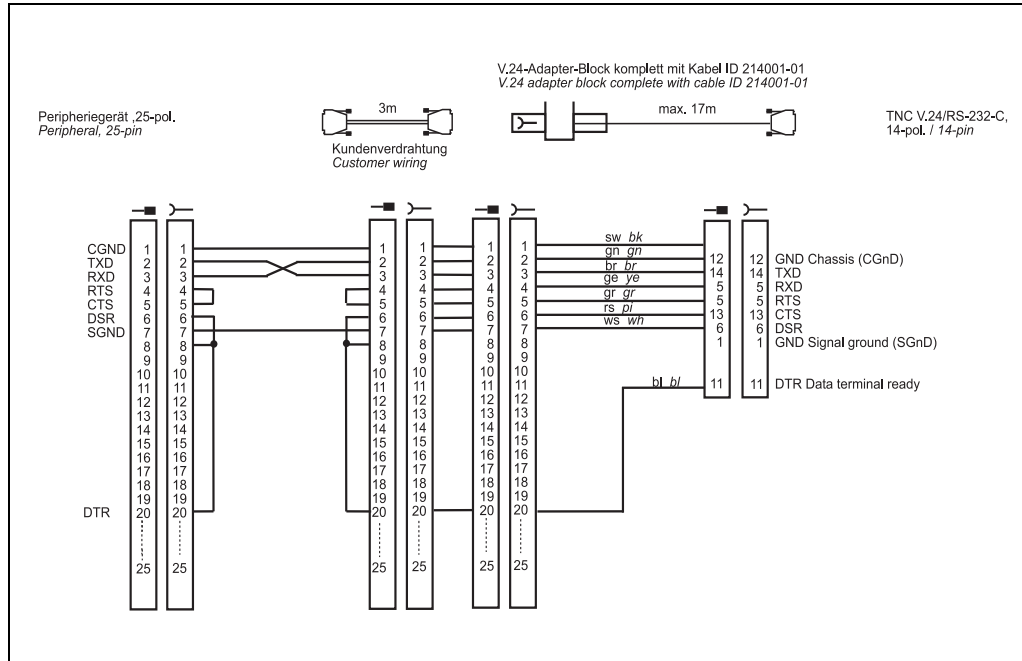

Diagram no. 9
RS-232-C /V.24 direct connection, TNC 14-pin / peripheral 9-pin

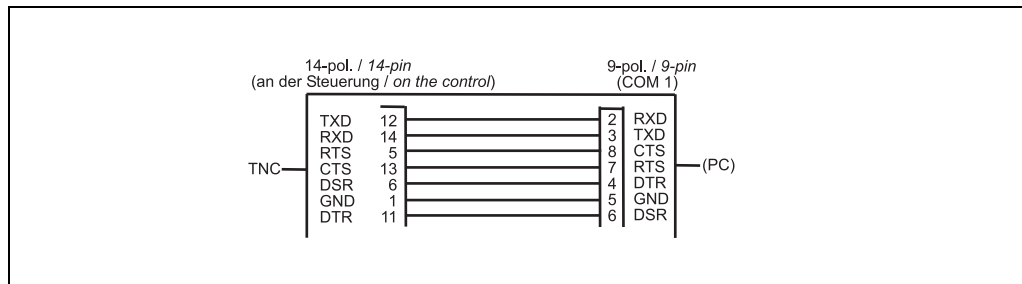

Diagram no. 10
RS-232-C /V.24 direct connection, TNC 25-pin / peripheral 9-pin

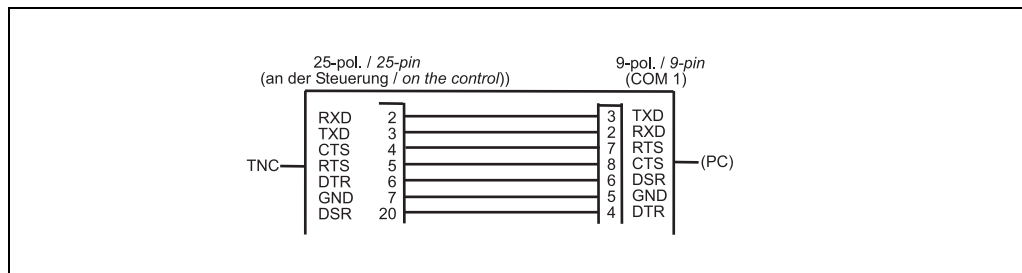

Diagram no. 11
RS-232-C/V.24 direct connection for hardware handshake,
TNC 25-pin / peripheral 25-pin (1:1)

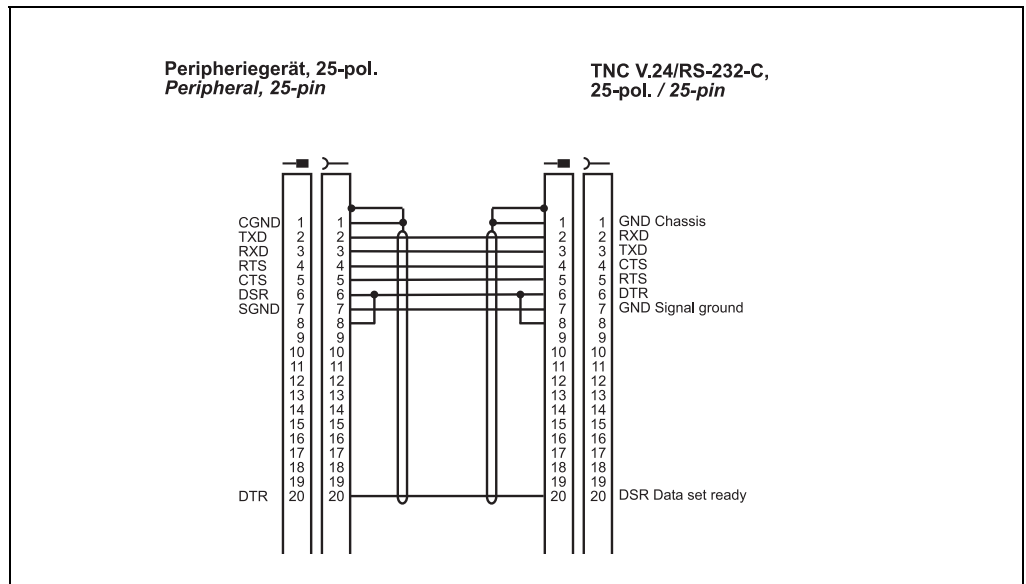

Diagram no. 12
RS-232-C/V.24 direct connection for software handshake,
TNC 25-pin / peripheral 25-pin (1:1)

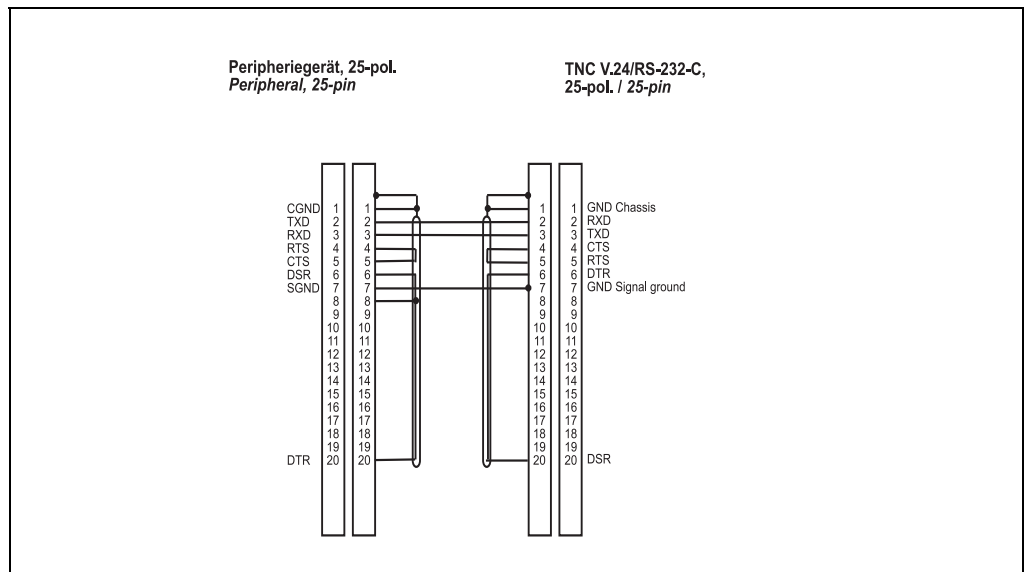

Diagram no. 13
RS-232-C / V.24 direct connection, TNC 14-pin / peripheral 25-pin

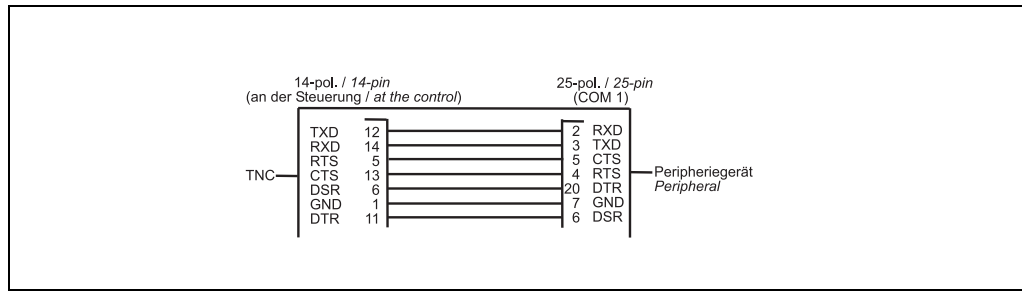
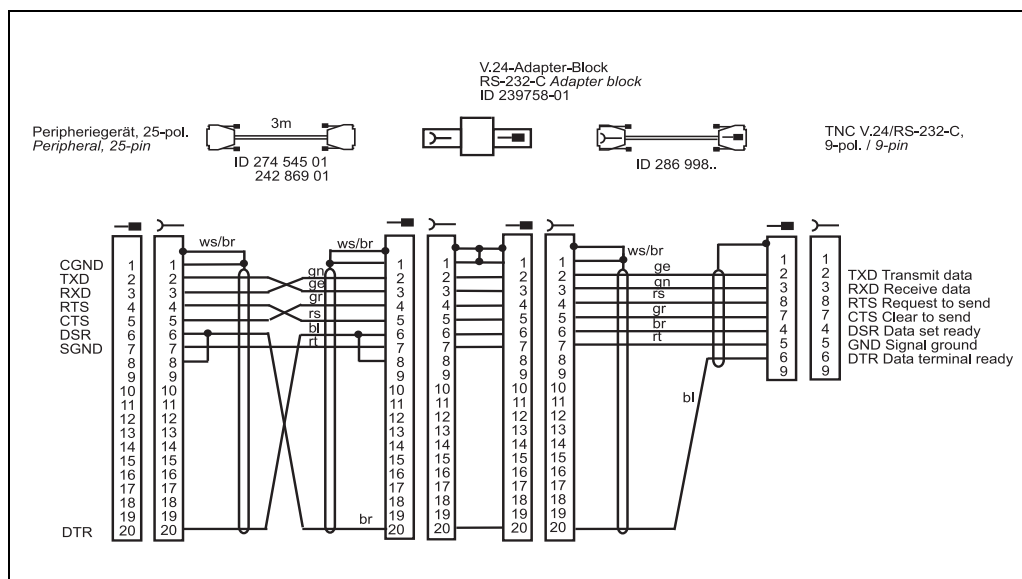

Diagram no. 14
RS-232-C/V.24 with adapter block for hardware handshake, TNC 9-pin / peripheral 25-pin



Note

If the pin layout of your peripheral unit differs from the above layout, the HEIDENHAIN connecting cable may not be used.

Diagram no. 15
RS-232-C/V.24 with adapter block for hardware handshake,
TNC 9-pin / peripheral 9-pin

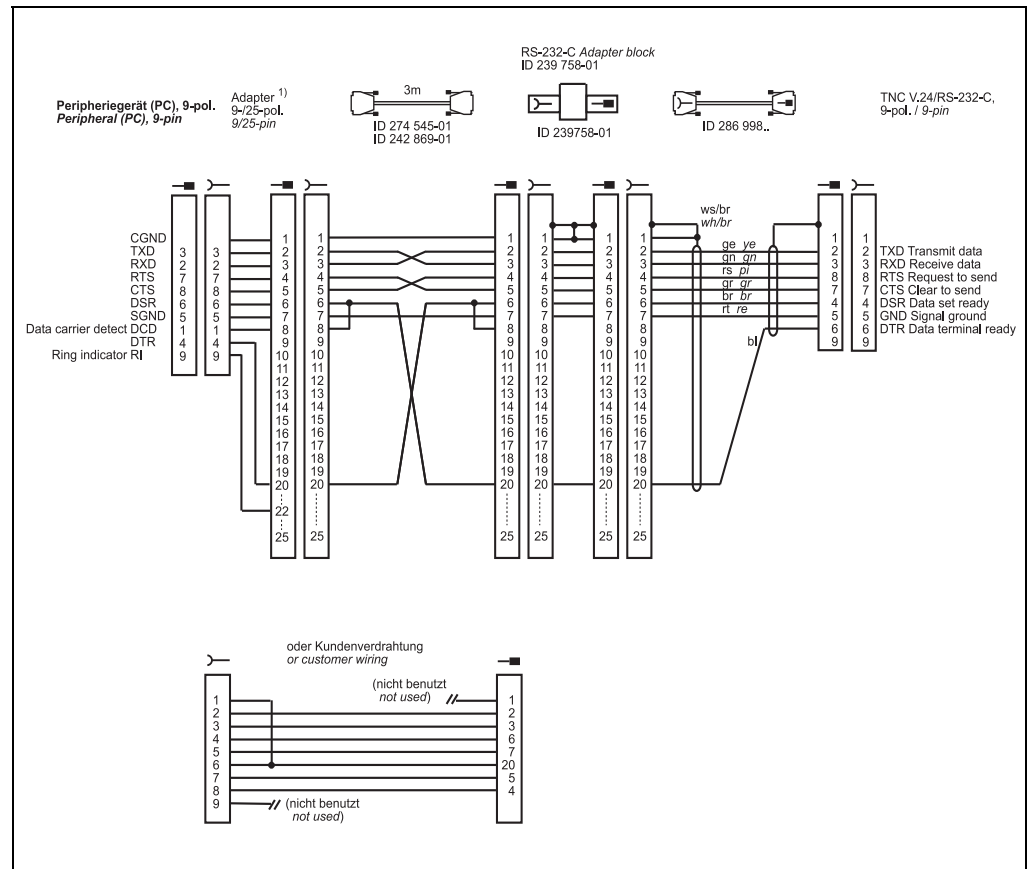

1) Customer wiring or part available on market

4.5 RS-422/V.11 Diagram

Diagram no. 16
RS-422/V.11 data interface

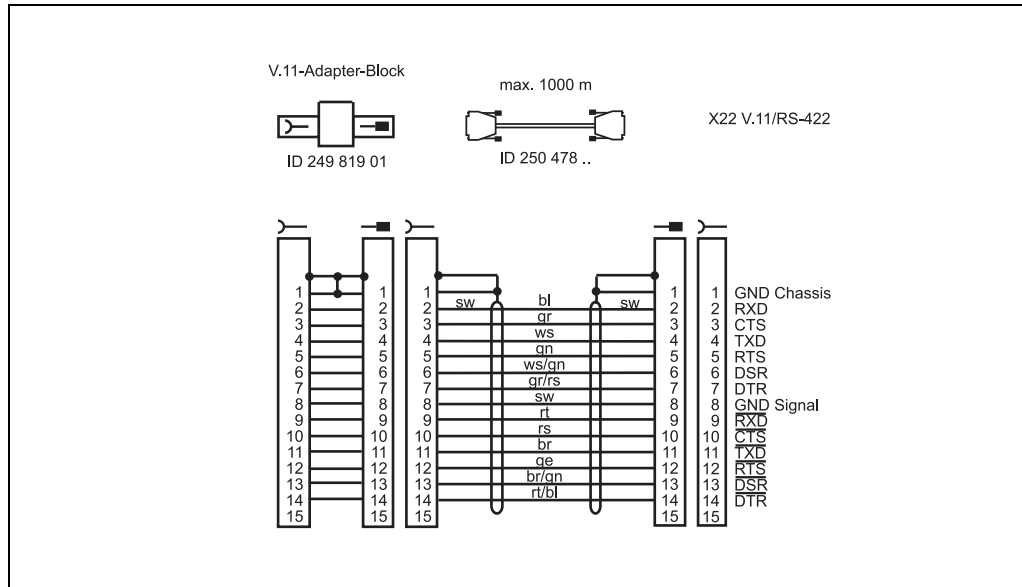

Note

The RS-422/V.11 data interface has the **same** pin layout at the logic unit X22 and at the V.11 adapter block.

4.6 V.11 -> V.24 Converter

Diagram no. 17

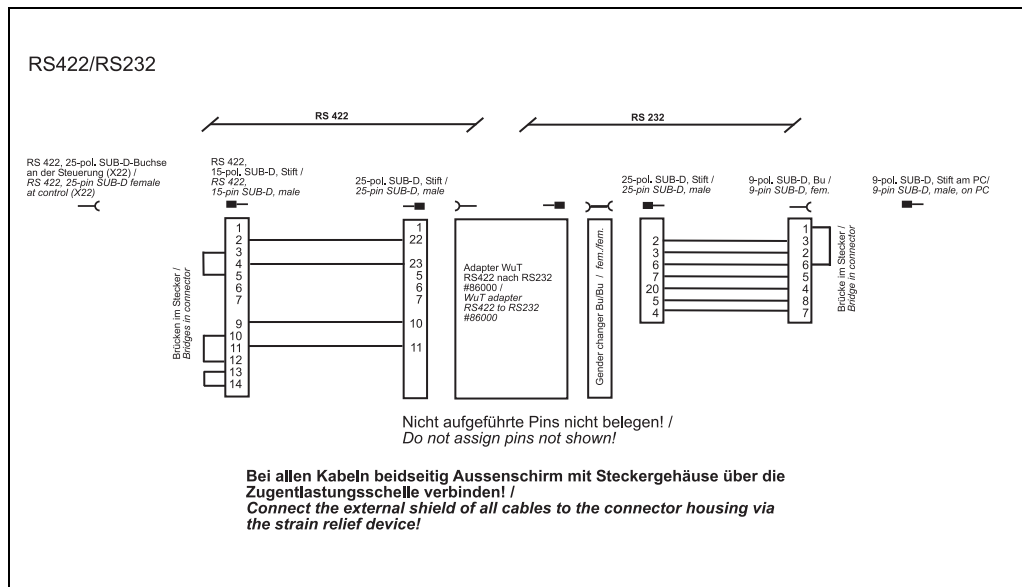

Note

The adapter can be ordered, e.g., from WIESEMANN & THEIS GmbH (www.wut.de).

5 Operating Modes of the Data Interfaces

5.1 Operating Modes on TNC 125, 131, 135, 145, 150, 151/155

One or several operating modes are available, depending on the control model.

Control model	Operating mode			
	ME	FE	EXT	
TNC 125	x			
TNC 131	x			
TNC 135	x			
TNC 145	x			
TNC 150	x			
TNC 151/155 B/Q ¹⁾	x	x	x	
TNC 151/155 A/P ²⁾	x	x	x	

ME:

For connection of the HEIDENHAIN magnetic tape unit MP 101/102 or other peripheral units. Data format (7 data bits, 1 stop bit, even parity) and baud rate (2400) are adapted to the FE.

FE:

For connection of the HEIDENHAIN floppy-disk unit FE 401 or other peripheral units. Data transfer is executed with a special protocol (blockwise transfer) to back up data. Data format (7 data bits, 1 stop bit, even parity), baud rate (9600) and transfer protocol are adapted to the FE.

EXT:

For adaptation of data transfer in standard data format and for blockwise transfer to peripheral units. The interface for data transfer is adapted via machine parameters; any baud rate can be selected.

¹⁾ Selection via MOD

²⁾ Selection via machine parameter

5.2 Operating Modes on TNC 122 to TNC 430

One or several operating modes are available, depending on the model.

Control model	Operating mode							
	ME	FE	EXT	LSV2	Screen dump	Host operation	DNC	Log
TNC 122	x	x	x					
TNC 124	x	x	x					
TNC 131	x							
TNC 135	x							
TNC 145	x							
TNC 150	x							
TNC 151 ¹⁾	x							
TNC 155 ¹⁾	x	x ⁵⁾	x ⁵⁾					
CNC 232 ¹⁾	x	x	x					
CNC 232B ¹⁾	x	x	x					
CNC 234 ¹⁾	x	x	x					
CNC 234.xxx ¹⁾	x	x	x					
CNC 332	x	x	x					
TNC 246	x	x	x				x	
TNC 2500/B/C	x ¹⁾	x	x				x	
TNC 306	x	x	x					
TNC 310	x	x	x		x		x	x
TNC 320		x	x	x	x			
TNC 335	x	x	x				x	
TNC 351/355	x	x	x				x	
TNC 360	x ¹⁾	x	x				x	
CONTOUR 12 ¹⁾	x	x						
TNC 370	x	x	x				x	
TNC 406 ²⁾	x	x	x	x	x	x		x
TNC 407	x	x	x	x ³⁾	x ³⁾		x ³⁾	x
TNC 410	x	x	x		x		x	x
TNC 415	x	x	x					
TNC 415B	x	x	x	x				
TNC 425	x	x	x	x ³⁾	x		x ³⁾	x
TNC 426 B / 430	x	x	x	x ^{4) 6)}	x ⁶⁾			x ⁶⁾
iTNC 530 ⁷⁾		x	x	x	x		x	x
TNC 6xx ⁷⁾		x	x	x	x		x	x

Control model	Operating mode							
	ME	FE	EXT	LSV2	Screen dump	Host operation	DNC	Log
MANUALplus M ⁷⁾			x					
MANUALplus 3110 ⁷⁾			x					
CNC PILOT 3190 ⁷⁾			x					
CNC PILOT 6xx ⁷⁾		x		x	x		x	x
GrindPlusIT ⁷⁾		x		x				
MillPlus ⁷⁾			x	x				
MillPlusIT V600 ⁷⁾		x	x	x	x		x	x

¹⁾ The transfer rate must be set to 9600 baud.

²⁾ Change of directory is not possible.

³⁾ Machine must support LSV2/DNC operation.

⁴⁾ File server (LSV2) as of software versions 280 462 05, 280 470 01, 280 472 01 only

⁵⁾ TNC 155B

⁶⁾ Via Ethernet as of software 280476-xx

⁷⁾ For further information, refer to the respective Technical Manual, User's Manual and Service Manual.

For internals settings please refer to the User's Manuals and Technical Manuals of the controls and DROs.

FE 1:

For connection of HEIDENHAIN floppy-disk unit FE 401 B (or floppy-disk unit FE 401, software 230 626 03 and later) or other peripheral units.

Data format and protocol adapted to FE 401/B

Protocol: Blockwise transfer

Data format: 7 data bits, 1 stop bit, even parity

Baud rate: 110 - 115 200 bauds
(depending on the hardware of the HEIDENHAIN product)

Interface parameters: Fixed

Transfer stop: Software handshake with DC3

FE 2:

For connection of the HEIDENHAIN floppy-disk unit FE 401 or other peripheral units.

Data format and protocol adapted to FE 401/B

Protocol: Blockwise transfer

Data format: 7 data bits, 1 stop bit, even parity

Baud rate: 110 - 115 200 bauds
(depending on the hardware of the HEIDENHAIN product)

Interface parameters: Fixed

Transfer stop: Software handshake with DC3

EXT:

For adaptation of data transfer in standard data format and for blockwise transfer to peripheral units.

Protocol:	Standard protocol or blockwise transfer Adaptation via machine parameters (from MP 5000)
Data format:	Adaptation via machine parameters (from MP 5000)
Baud rate:	110 - 115 200 bauds (depending on the hardware of the HEIDENHAIN product)
Interface parameters:	Adaptation via machine parameters (from MP 5000)
Transfer stop:	Software handshake with DC3 or hardware handshake with RTS, selectable via machine parameters (from MP 5000)

LSV-2:

With the appropriate software (TNCremo V 3.0), the LSV-2 protocol allows various functions such as file management, remote control, and diagnosis of the TNC to be executed from the PC.

Protocol:	Bidirectional data transfer in accordance with DIN 66019
Data format:	8 data bits, 1 stop bit, no parity
Baud rate:	110 - 115 200 bauds (depending on the hardware of the HEIDENHAIN product)
Interface parameters:	Fixed
Transfer stop:	Software handshake via protocol

6 Machine Parameters for the Data Interfaces

6.1 Machine Parameters for TNC 125, 131, 135, 145, 150, 151/155, 351/355

6.1.1 Overview

Function	TNC							
	125	131	135	145	145C	150	151/155	351/355
General information								
Data format	-	-	-	-	-	-	MP 222 Bit 0	MP 222 Bit 0
ASCII characters for beginning and end of program	-	-	-	-	MP 76	MP 71	MP 71	MP 71
Decimal point or comma	-	-	-	-	MP 70	MP 92	-	-
Blockwise transfer								
Operating mode of RS-232-C	-	-	-	-	-	-	MP 223	MP 223
ASCII characters for data input and data output	-	-	-	-	-	-	MP 218 MP 219	MP 218 MP 219
Command block Start/End	-	-	-	-	-	-	MP 220	MP 220
Pos./neg. acknowledge	-	-	-	-	-	-	MP 221	MP 221
Data transfer finished	-	-	-	-	-	-	MP 224	MP 224
Printer adaptation								
Output of control characters at the beginning of each graphics	-	-	-	-	-	-	MP 226 MP 227 MP 228 MP 229	MP 226 MP 227 MP 228 MP 229
Output of control characters at the beginning of each graphic line	-	-	-	-	-	-	MP 230 MP 231 MP 232 MP 233	MP 230 MP 231 MP 232 MP 233
Character parity	-	-	-	-	-	-	MP 222 Bit 4-7	MP 222 Bit 4-7
Transfer stop	-	-	-	-	-	-	MP 222 Bit 2-3	MP 222 Bit 2-3

6.1.2 Description of the machine parameters

Machine parameters - general information

Data format

As of **TNC 151 B/Q** the data format can be set in the machine parameter MP 222.

MP 222 (5020)	Bit 0	0	^	7 data bits (ASCII code, bit 8 = parity)
		1	=	8 data bits (ASCII code, bit 8 = 0, bit 9 = parity)
	Bit 1	0	^	no BCC check
		1	=	BCC check
	Bit 2	1	^	Transfer stop by hardware handshake
	Bit 3	1	=	Transfer stop by software handshake
	Bit 4	0	^	Even character parity
		1	=	Odd character parity
	Bit 5	1	^	Character parity desired
	Bit 7, 6	00	^	1 1/2 stop bits
		01	=	2 stop bits
		10	=	1 stop bit
		11	=	1 stop bit

Example:

For "Blockwise transfer" with the HEIDENHAIN data transfer software in the EXT mode, the data format must be as follows:

7 data bits, 1 stop bit, even parity, software handshake

7	6	5	4	3	2	1	0	Bit
1	0	1	0	1	0	0	0	Binary
↓		↓		↓				
128	+	32	+	8				=168 Decimal

In the "FE/ME" mode, the data format in MP 222 is not active; in this case the format is always set to 7 data bits, 1 stop bit, even parity and software handshake.

Machine parameters for blockwise transfer

With Blockwise Transfer in the "Program Run" operating mode, machine programs - in general created on a remote computer-aided workstation - of any desired length can be downloaded and machined via the serial interface.

Blocks already machined are deleted from the memory and the next program blocks requested from the external memory.

With BLOCKWISE TRANSFER the data flow is not stopped by RTS or DC3, but only by the control characters ACK (acknowledge = positive) and NAK (not acknowledge = negative).

Each transferred block is checked by means of a BCC (block check character), i.e. the received data are checked for longitudinal parity. If both values are the same, positive acknowledgment is transmitted; if they are not identical, negative acknowledgment is transmitted.

This block is repeated up to three times. If the result is negative in each case, data transfer is aborted and an error message generated.

Parameter No.	Bit	Function	Entry values for
71 or 5010.0	0 ... 7 8 ... 15	ETX or any ASCII character; character for End of Program STX or any ASCII character; character for Start Program	ETX and STX: 515
218 or 5010.1	0 ... 7 8 ... 15	H or any ASCII character; transmitted in the a command block for data input <u>before the program number</u> . E or any ASCII character; transmitted in the a command block for data input <u>after the program number</u> .	H and E: 17736
219 or 5010.2	0 ... 7 8 ... 15	H or any ASCII character; transmitted in the a command block for data output <u>before the program number</u> . A or any ASCII character; transmitted in the a command block for data output <u>after the program number</u> .	H and A: 16712
220 or 5010.3	0 ... 7 8 ... 15	ETB or substitute character (decimal code 1 - 47); transferred at the end of the command block. SOH or substitute character (decimal code 1 - 47); transferred at the beginning of the program block.	ETB or SOH: 279
221 or 5010.4	0 ... 7 8 ... 15	ACK or substitute character (decimal code 1 - 47); positive acknowledge, transferred if the data block was been correctly received. NAK or substitute character (decimal code 1 - 47); negative acknowledge, transferred if the data block was not correctly received.	ACK or NAK: 5382
224 or 5010.5	0 ... 7	EOT or substitute character (decimal code 1 - 47); transferred at the end of data transfer.	EOT: 4

For MP 218 (5010.1) and MP 219 (5010.2)

H = HEIDENHAIN conversational program

D = ISO program

M = Machine parameter list

P = PLC program

S = Non-linear compensation list

X99999967 = For all programs stored in the ME mode

Machine parameter calculation

Examples: MP 218 (5010.1) - MP 221 (5010.4) and MP 224 (5010.5)

	15	MSB	8	7	LSB	0	
MP 218 (5010.1):	E (69)				H (72)		
	69 x 256				+	72	= <u>17736</u>

MP 218 (5010.1) = 17736

The LSB must correspond to the transfer program.
("Change identifier" in FDE program)

- X (88) - User parameter (general) ME mode
- H (72) - Programs in HEIDENHAIN plain language
- D (68) - ISO programs
- P (80) - PLC programs
- M (77) - Machine parameters
- S (83) - Non-linear compensation table

The MSB must correspond to the transfer program.
("E" is prescribed in the FDE/TNC program.)

	15	MSB	8	7	LSB	0	
MP 219 (5010.2):	A (65)				H (72)		
	65 x 256				+	72	= <u>16712</u>

MP 219 (5010.2) = 16712

The LSB can be selected as in the above example; however, it must be the same for both machine parameter and identifier.

The MSB is "A" as in the FDE/TNC program.

	15	MSB	8	7	LSB	0	
MP 220 (5010.3):	SOH (1)				ETB (23)		
	1 x 256				+	23	= <u>279</u>

MP 220 (5010.3) = 279

SOH and ETB are fixed for the FDE/TNC program. Otherwise a substitute character can be selected which must match the data transfer software.

	15	MSB	8	7	LSB	0	
MP 221 (5010.4):	NAK (21)				ACK (6)		
	21 x 256				+	6	= <u>5382</u>

MP 221 (5010.4) = 5382

ACK/NAK is defined for the FDE/TNC program; otherwise a matching substitute character can be selected in the data transfer software.

MP 224 (5010.5):

EOT (4)

4 = **4**

MP 224 (5010.5) = 4

Prescribed for the FDE/TNC program; otherwise selectable as above.

For our example the following values must be entered in the machine parameter list:

MP 71	(5010.0)	=	515	(STX, ETX)
MP 218	(5010.1)	=	17736	(E, H)
MP 219	(5010.2)	=	16712	(A, H)
MP 220	(5010.3)	=	279	(SOH, ETB)
MP 221	(5010.4)	=	5382	(NAK, ACK)
MP 222	(5020)	=	168	(7 data bits, 1 stop bit, even parity, xon/xoff)
MP 223	(5030)	=	1	(blockwise transfer active)
MP 224	(5010.5)	=	4	(EOT)

Printer adaptation

General information on graphic output



Note

Your printer manual is absolutely required!

Proceeding:

Via the DIP switches the printer must be configured such that it matches the configuration of the control.

Control settings:

1. At the control, the **RS-232-C interface** must be set to **EXT**. (The interface can be selected with the MOD key; pressing ENT changes the setting.)
2. The **baud rate** must also be selected via MOD and a value entered. (Observe the settings of the DIP switches at the printer.)
3. Data format: 8 data bits, 1 stop bit, even parity, software handshaking. The data format is set in **MP 222 (MP 5020): 169**.
4. The EXT control character for end of program is set in the machine parameter **MP 71 (MP 5010.0): 3**.
5. Blockwise transfer must be deactivated in **MP 223 (MP 5030): 0**.
6. Enter **MP 226 (MP 5110.0) to MP 233 (MP 5120.3)**.
Machine parameter calculation is explained on the following pages.

The printer manual is required to define the escape sequences.

The values determined must be entered in the machine parameter list.

Machine parameter calculation for graphic output

In the graphics mode the display of the TNC 155/355 consists of 512 x 490 pixels. For graphic data output, the data is output line by line in 8-bit format via the serial interface. A line consists of 8 pixels and 512 bytes.

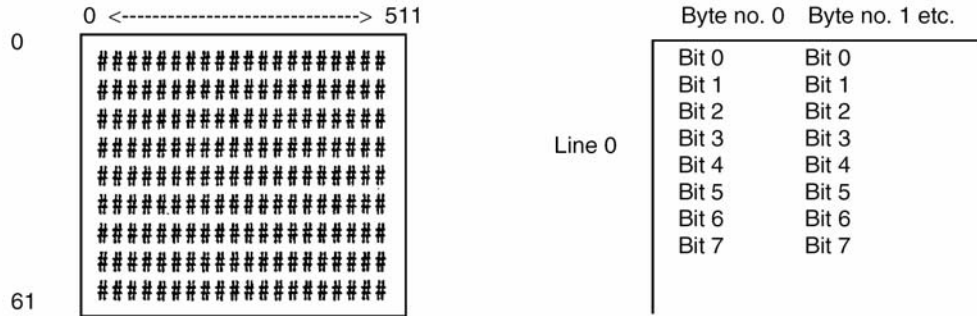

represents one byte on the screen

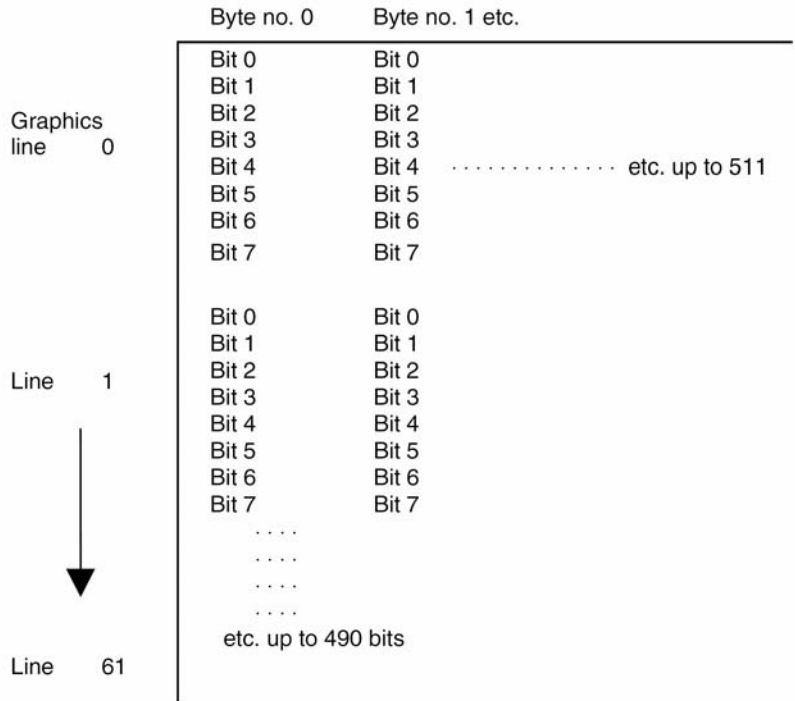

The parameters are subdivided into two blocks:

The first block (MP 226 (5110.0) to MP 229 (5110.3)) is sent once before each block. It serves to initialize the printer and to set the general parameters for graphic output, e.g. line spacing, carriage return, line feed and possibly form feed to reach the beginning of the print paper.

The line feed must be specified such that the graphic lines are printed without blanks in between. For this reason, the line spacing should be 72/216 inches.

The second parameter block (MP 230 (5120.0) to MP 233 (5120.3)) is output before each graphic line to perform carriage return and line feed at the printer and to set it to the graphics mode.

The control outputs 512 data bytes per line, i.e. 512 bytes must be displayed as graphics on paper before the printer automatically switches from the graphics mode to ASCII mode.

The commands for the printer are described in escape sequences which may vary from printer to printer.

The EPSON command set for printers is a quasi-standard supported by most printer manufacturers. Therefore, this manual refers to these EPSON ESCAPE SEQUENCES.

The following escape sequences and ASCII characters must be transferred to the printer for initialization:

The machine parameters MP 226 (5110.0) to MP 233 (5120.3) are present as 16-bit values and are output in decimal format. The input value may be between 0 and 65535. These machine parameters are subdivided into bytes.

The most significant byte from MP 226 (5110.0) and MP 230 (5120.0) defines the number of bytes the control outputs via RS-232-C.

The entry values 0 to 7 are advisable, as up to 7 bytes can be transferred. The next bytes are output individually in ascending order.

Example:

The escape sequences stated below are not generally valid; they must be defined individually for each printer (with the help of the printer manual).

Machine parameter block 1: MP 226 (5110.0) to MP 229 (5110.3)

Output of control characters at the beginning of each graphics

Required:	Character	ASCII code	Result
1. Form feed	FF	12 DEC.	Form Feed
2. Carriage return	CR	13 DEC.	Carriage Return
3. Line feed	LF	10 DEC.	Line Feed
4. Line spacing	ESC	27 DEC.	Escape
5. set to	3	51 DEC.	3 in ASCII code
6. 72/216"	H	72 DEC.	H in ASCII code

Byte counter → 6	FF	CR	LF	ESC	3	H
------------------	----	----	----	-----	---	---

Result:

	15	MSB	8	7	LSB	0	
MP 226 (5110.0):	Byte counter (6)		FF (12)		Byte 1		
	6 * 256		+		12		= 1548
MP 227 (5110.1):	CR (13)		LF (10)		Byte 3		
	13 * 256		+		10		= 3338
MP 228 (5110.2):	ESC (27)		3 (51)		Byte 5		
	27 * 256		+		51		= 6963
MP 229 (5110.3):	H (72)		-- (0)		Byte 7		
	72 * 256		+		0		= 18432

Input values:
 MP 226 (5110.0): 1548
 MP 227 (5110.1): 3338
 MP 228 (5110.2): 6963
 MP 229 (5110.3): 18432

Machine parameter block 2: MP 230 (5120.0) to MP 233 (5120.3)

Output of control characters at the beginning of each graphic line

Required:	Character	ASCII code	Result
1. Carriage Return	CR	13 DEC.	Carriage Return
2. Line Feed	LF	10 DEC.	Line Feed
3. Graphics mode with 8	ESC	27 DEC.	Escape
4. needles	*	42 DEC.	Asterisk
5. 72 dpi and	5 DEC.	5 DEC.	Decimal 5
6. 512 data bytes	0 DEC.	0 DEC.	Decimal 0
7. per line	2 DEC.	2 DEC.	Decimal 2

Byte counter → 7	CR	LF	ESC	*	5	0	2
------------------	----	----	-----	---	---	---	---

Result:

	15	MSB	8	7	LSB	0	
MP 230 (5120.0):	Byte counter (7) Byte 0		CR (13) Byte 1				
	7 * 256		+		13		= 1805
MP 231 (5120.1):	LF (10) Byte 2		ESC (27) Byte 3				
	10 * 256		+		27		= 2587
MP 232 (5120.2):	* (42) Byte 4		5 DEC. (5) Byte 5				
	42 * 256		+		5		= 10757
MP 233 (5120.3):	0 DEC. (0) Byte 6		2 DEC. (2) Byte 7				
	0 * 256		+		2		= 2

Input values

MP 230 (5120.0) :	1805
MP 231 (5120.1) :	2587
MP 232 (5120.2) :	10757
MP 233 (5120.3) :	2

6.2 Machine Parameters for TNC 122/124

6.2.1 Overview

Function	TNC		
	122	124	
Data transfer rate	-	5040	

6.2.2 Description of the machine parameters

The following list contains the machine parameters for all software variants.

Since however, several machine parameters are not valid for certain controls or have been introduced or eliminated as of a certain software version, there are columns with symbols for differentiation.

Meaning of the symbols

- ◆ = The parameter applies for **all** software versions of this control.
- 04** = The parameter was **introduced** as of a certain software version (e.g. as of version 04).
- I04** = The parameter was **eliminated** as of a certain software version (e.g. as of version 04) or **replaced** by a new parameter.
- = The parameter is not active with this software (control).

Explanation of the columns

TNC 124 = TNC 124 with NC software 246 16* –

Function	MP No.	Bit	TNC 124				Input
Data transfer rate	5040		◆				300 600 1200 2400 4800 9600 19200 38400

6.3 Machine Parameters for TNC 232/246

6.3.1 Overview

Function	TNC					
	232	246				
Control character for "Blockwise Transfer" Character for beginning and end of program; the character for program end also applies for "standard data interface"	5010.0	5010.0				
ASCII character for data input	5010.1	5010.1				
ASCII character for data output	5010.2	5010.2				
ASCII character for beginning and end of command block	5010.3	5010.3				
ASCII character for pos. and neg. acknowledge	5010.4	5010.4				
ASCII character for "data transfer finished"	5010.5	5010.5				
Data format and transfer stop for the data interface	5020	5020				
Transfer mode for EXT	5030	5030				

6.3.2 Description of the machine parameters

Function	MP No.	Bit	TNC 246 B	CNC 232 B		Input															
Control character for "Blockwise Transfer" Character for beginning and end of program; the character for program end also applies for "standard data interface"	5010.0*		♦	♦		0 ... 65 535															
ASCII character for data input	5010.1*		♦	♦		0 ... 65 535															
ASCII character for data output	5010.2*		♦	♦		0 ... 65 535															
ASCII character for beginning and end of command block	5010.3*		♦	♦		0 ... 65 535															
ASCII character for pos. and neg. acknowledge	5010.4*		♦	♦		0 ... 65 535															
ASCII character "Data transfer finished"	5010.5*		♦	♦		0 ... 65 535															
Data format and transmission stop for the data interface RS-232-C/V.24 7 or 8 data bits	5020*	0	♦	♦		0 .. 255 + 0 → 7 data bits (ASCII code 8th bit = parity) + 1 → 8 data bits (ASCII code 8th bit = 0 and 9th bit = parity)															
Block check character		1				+ 0 → any BCC + 2 → BCC not control character															
Transmission stop by RTS		2				+ 0 → not active + 4 → active															
Transmission stop by DC3		3				+ 0 → not active + 8 → active															
Character parity even		4				+ 0 → not active + 16 → active															
or Character parity odd		5				+ 0 → even + 32 → odd															
Character parity desired		6/7																			
						<table border="1"> <tr> <td>7</td> <td>6</td> <td></td> </tr> <tr> <td>0</td> <td>0</td> <td>1 ½ stop bits</td> </tr> <tr> <td>0</td> <td>1</td> <td>2 stop bits</td> </tr> <tr> <td>1</td> <td>0</td> <td>1 stop bit</td> </tr> <tr> <td>1</td> <td>1</td> <td>1 stop bit</td> </tr> </table>	7	6		0	0	1 ½ stop bits	0	1	2 stop bits	1	0	1 stop bit	1	1	1 stop bit
7	6																				
0	0	1 ½ stop bits																			
0	1	2 stop bits																			
1	0	1 stop bit																			
1	1	1 stop bit																			
						Bit 6: + 64 Bit 7: + 128															
Operating mode of the data interface RS-232-C/V.24	5030*		♦	♦		0 → "Standard data transfer" 1 → "Transfer blockwise"															

* accessible via code number 123

6.4 Machine Parameters for TNC 306/335/360/2500/CNC 234/TNC 370

6.4.1 Overview

Function	TNC						
	234	306	335	360	2500	370	
Control character for end of text (ETX)	-	5010	-	-	-	-	
1. control character for end of text (ETX) 2. control character for start of text (STX)	5010.0	-	5010.0	5010.0	5010.0	5010.0	
1. ASCII character for file type for data input 2. ASCII character for input code (E)	5010.1	-	5010.1	5010.1	5010.1	5010.1	
1. ASCII character for file type for data output 2. ASCII character for output code (A)	5010.2	-	5010.2	5010.2	5010.2	5010.2	
1. control character for end of command block (ETB) 2. control character for start of command block (SOH)	5010.3	-	5010.3	5010.3	5010.3	5010.3	
1. control character for pos. acknowledge (ACK) 2. control character for neg. acknowledge (NAK)	5010.4	-	5010.4	5010.4	5010.4	5010.4	
Control character for end of data transfer (EOT)	5010.5	5011	5010.5	5010.5	5010.5	5010.5	
Transfer mode for EXT	5030	-	5030	5030	5030	5030	
Data transfer rate for PLC coupling	-	-	5040	5040	-	-	
Graphic printout	-	-	-	-	-	-	
Graphic printout	-	-	-	-	-	-	
Block check number sequence with data transfer from interface	-	5990	-	-	-	-	
Data format and transmission stop for the data interface RS-232-C/EXT	5020	-	5020	5020	5020	5020	

6.4.2 Description of the machine parameters

Function	MP No.	Bit	TNC 2500	TNC 360	*NC 306	CNC 234	Input
Control character for end of text (ETX)	5010		-	-	04	-	0 ... 255
1. control character f. end of text (ETX) 2. control character f. start of text (STX)	5010.0*		♦	♦	-	♦	0 ... 32382
1. ASCII character for file type for data input 2. ASCII character for input code (E)	5010.1*		♦	♦	-	♦	0 ... 32382
1. ASCII character for file type for data output 2. ASCII character for output code (A)	5010.2*		♦	♦	-	♦	0 ... 32382
1. control character for end of command block (ETB) 2. control character for start of command block (SOH)	5010.3*		♦	♦	-	♦	0 ... 32382
1. control character for positive acknowledge (ACK) 2. control character for negative acknowledge (NAK)	5010.4*		♦	♦	-	♦	0 ... 32382
Control character for end of data transfer (EOT)	5010.5*		♦	♦	-	♦	0 ... 32282
Control character for end of data transfer (EOT)	5011		-	-	04	-	0 ... 32382
Data format and transmission stop for the RS-232-C/EXT data interface 7 or 8 data bits	5020*	0	♦	♦	♦	♦	0 ... 255 + 0 = 7 data bits, bit 8 = parity + 1 = 8 data bits, bit 8 = 0 and bit 9 = parity
Block check character		1					+ 0 = any BCC + 2 = BCC not control character
Transmission stop by RTS		2					+ 0 = not active + 4 = active
Transmission stop by DC3		3					+ 0 = not active + 8 = active
Character parity even/odd		4					+ 0 = even + 16 = odd
Character parity on/off		5					+ 0 = off + 32 = on
Number of stop bits		6/7					+ 64 => bit 6 = 1 + 128 => bit 7 = 1 6/7
Activation of RTS signal		8	11	16	-	08	0/1 = 1 1/2 stop bits 1/0 = 2 stop bits 0/1 = 1 stop bit 1/1 = 1 stop bit + 0 = RTS signal always active + 256 = RTS signal is set active when data transfer is activated and set inactive at the end of data transfer.
Control sends EOT after having received ETX		9	11	17	-	-	+ 0 = EOT is transmitted + 512 = EOT is not transmitted

* Accessible via code number 123

Function	MP No.	Bit	TNC 2500	TNC 360	*NC 306	CNC 234	Input
Transfer mode for EXT	5030*		♦	♦	-	♦	0 = "Standard data interface" 1 = "Blockwise transfer"
Data transfer rate for PLC coupling	5040		-	03	-	-	0 = 110 [Bd] 1 = 150 2 = 300 3 = 600 4 = 1200 5 = 2400 6 = 4800 7 = 9600 8 = 19200 9 = 38400
Graphic printout	5110.0 5110.1 5110.2 5110.3		l04	-	-	-	0 = without function
Graphic printout	5120.0 5120.1 5120.2 5120.3		l04	-	-	-	0 = without function
Block check number sequence with data transfer from interface	5990		-	-	♦	-	0 = NC PGM with block numbers 1 = NC PGM without block numbers

accessible via code number 123

-) Example for the calculation of these machine parameters:
 (decimal code 1st character)+ (256 x decimal code 2nd character) = input value
 3 (ETX) + 256 x (STX) = 515

6.5 Machine Parameters for TNC 310/410

6.5.1 Overview

Function	TNC					
	310	410				
Data format and transmission stop for the operating mode EXT1 for the operating mode EXT2 for the operating mode EXT3 (PLC)	5020.0 5020.1 5020.2	5020.0 5020.1 5020.2				
Transfer mode for EXT1 EXT2 EXT3 (PLC)	5030.0 5030.1 5030.2	5030.0 5030.1 5030.2				
Data transfer rate for PLC coupling (EXT3)	5040	5040				

6.5.2 Description of the machine parameters

Function	MP No.	Bit	A	B	C	D	Input
Data format and transmission stop for the operating mode EXT1 for the operating mode EXT2 for the operating mode EXT3	5020.0 5020.1 5020.2	♦ ♦ ♦					0 ... 255
7 or 8 data bits		0					+ 0 = 7 data bits, bit 8 = parity + 1 = 8 data bits, bit 8 = 0 and bit 9 = parity
Block check character		1					+ 0 = any BCC + 2 = BCC not control character
Transmission stop by RTS		2					+ 0 = inactive + 4 = active
Transmission stop by DC3		3					+ 0 = inactive + 8 = active
Character parity even / odd		4					+ 0 = even 6 = odd
Character parity on / off		5					+ 0 = off + 32 = on
Number of stop bits		6 7					+ 64 → bit 6 = 1 +128 → bit 7 = 1 bit 6 bit 7 0 1 = 1½ stop bits 1 0 = 2 stop bits 0 1 = 1 stop bit 1 1 = 1 stop bit
Activation of RTS signal		8					+ 0 = RTS signal always active + 256 = RTS signal is set active when data transfer is activated and set inactive at the end of data transfer.
Control sends EOT after having received ETX		9					+ 0 = EOT is transmitted + 512 = EOT is not transmitted
Transfer mode for EXT1 EXT2 EXT3	5030.0 5030.1 5030.2	♦ ♦ ♦					0 = "Standard data transfer" 1 = "Blockwise transfer"
Data transfer rate for PLC coupling (EXT3)	5040	♦					0 ... 9 0 = 110 Bd 5 = 2400 Bd 10 = 57600 Bd 1 = 150 Bd 6 = 4800 Bd 11 = 115200 Bd 2 = 300 Bd 7 = 9600 Bd 3 = 600 Bd 8 = 19200 Bd 4 = 1200 Bd 9 = 38400 Bd

6.6 Machine Parameters for TNC 406/407/415/425

6.6.1 Overview

Function	TNC				
	406	407	415	425	
Inhibiting a data interface	5000	5000	5000	5000	
Data format and transmission stop					
for the operating mode EXT1	5020.0	5020.0	5020.0	5020.0	
for the operating mode EXT2	5020.1	5020.1	5020.1	5020.1	
for the operating mode EXT3 (PLC)	5020.2	5020.2	5020.2	5020.2	
Transfer mode for					
EXT1	5030.0	5030.0	5030.0	5030.0	
EXT2	5030.1	5030.1	5030.1	5030.1	
EXT3 (PLC)	5030.2	5030.2	5030.2	5030.2	
Data transfer rate for PLC coupling (EXT3)	5040	5040	5040	5040	
Control characters for "Blockwise transfer"					
ASCII character for start of program					
EXT1 (STX)	5200.0	5200.0	5200.0	5200.0	
EXT2	5200.1	5200.1	5200.1	5200.1	
EXT3 (PLC)	5200.2	5200.2	5200.2	5200.2	
ASCII character for end of program					
for EXT1 (ETX)	5201.0	5201.0	5201.0	5201.0	
for EXT2	5201.1	5201.1	5201.1	5201.1	
for PLC	5201.2	5201.2	5201.2	5201.2	
ASCII character for file type for data input					
for EXT1	5202.0	5202.0	5202.0	5202.0	
for EXT2	5202.1	5202.1	5202.1	5202.1	
for PLC	5202.2	5202.2	5202.2	5202.2	
ASCII character for input code					
for EXT1 (E)	5203.0	5203.0	5203.0	5203.0	
for EXT2	5203.1	5203.1	5203.1	5203.1	
for PLC	5203.2	5203.2	5203.2	5203.2	
ASCII character for file type for data output					
for EXT1	5204.0	5204.0	5204.0	5204.0	
for EXT2	5204.1	5204.1	5204.1	5204.1	
for EXT3 (PLC)	5204.2	5204.2	5204.2	5204.2	
ASCII character for output code					
for EXT1 (A)	5205.0	5205.0	5205.0	5205.0	
for EXT2	5205.1	5205.1	5205.1	5205.1	
for EXT3 (PLC)	5205.2	5205.2	5205.2	5205.2	
ASCII character for start of command block					
for EXT1 (SOH)	5206.0	5206.0	5206.0	5206.0	
for EXT2	5206.1	5206.1	5206.1	5206.1	
for EXT3 (PLC)	5206.2	5206.2	5206.2	5206.2	
ASCII character for end of command block					
for EXT1 (ETB)	5207.0	5207.0	5207.0	5207.0	
for EXT2	5207.1	5207.1	5207.1	5207.1	
for EXT3 (PLC)	5207.2	5207.2	5207.2	5207.2	
ASCII character for positive acknowledge					
for EXT1 (ACK)	5208.0	5208.0	5208.0	5208.0	
for EXT2	5208.1	5208.1	5208.1	5208.1	
for EXT3 (PLC)	5208.2	5208.2	5208.2	5208.2	
ASCII character for negative acknowledge					
EXT1 (NAK)	5209.0	5209.0	5209.0	5209.0	
EXT2	5209.1	5209.1	5209.1	5209.1	
EXT3 (PLC)	5209.2	5209.2	5209.2	5209.2	
ASCII character for end of transmission					
EXT1 (EOT)	5210.0	5210.0	5210.0	5210.0	
EXT2	5210.1	5210.1	5210.1	5210.1	
EXT3 (PLC)	5210.2	5210.2	5210.2	5210.2	

6.6.2 Description of the machine parameters of TNC 406/407/415

Machine parameters

The following list contains the machine parameters for all software variants. Since however, several machine parameters are only valid for a certain software or have been introduced or eliminated as of a certain software version, there are columns with symbols for differentiation.

Meaning of the symbols

- ◆ = The machine parameter or entry value applies for all software versions of this control.
- 04** = The machine parameter has been introduced with a certain software version (e.g. with version 04).
- I04** = The machine parameter is inactive.
- = The parameter does not exist on this control.

Explanation of the columns

- A = TNC 407 with NC software 243 07* -- (without digitizing function)
- B = TNC 415 with NC software 243 05* -- or 259 91* -- (without digitizing function)
- C = TNC 407 with NC software 243 02* -- (with digitizing function)
- D = TNC 415 with NC software 259 96* -- or 259 97* -- (with digitizing function)
- E = TNC 407 with NC software 243 03* -- (software equivalent to TNC 415B/425)
- F = TNC 407 with NC software 280 58* -- (special software)

Function	MP No.	Bit	A	B	C	D	E	F	Input
Inhibiting a data interface	5000	07	09	♦	♦	♦	♦		0 = no interface inhibited 1 = RS-232 inhibited 2 = RS-422 inhibited
Control characters for "Blockwise transfer" Character for program end and start; the character for program end is also valid for the "standard data interface"	5010.0*	105	108	-	-	-	-		0 ... 32 382
ASCII character for data input	5010.1*	105	108	-	-	-	-		0 ... 32 382
ASCII character for data output	5010.2*	105	108	-	-	-	-		0 ... 32 382
ASCII character for start and end of command block	5010.3*	105	108	-	-	-	-		0 ... 32 382
ASCII character for pos. and neg. acknowledge	5010.4*	105	108	-	-	-	-		0 ... 32 382
ASCII character "data transfer finished"	5010.5*	105	108	-	-	-	-		0 ... 32 382
Data format and transmission stop for the operating mode EXT		105	108	-	-	-	-		0 ... 255
for the operating mode EXT1	5020.0*	05	08	♦	♦	♦	♦		
for the operating mode EXT2	5020.1*	05	08	♦	♦	♦	♦		
for the operating mode EXT3 (PLC)	5020.2*	-	-	♦	♦	♦	♦		
7 or 8 data bits		0							+ 0 = 7 data bits, bit 8 = parity + 1 = 8 data bits, bit 8 = 0 and bit 9 = parity
Block check character		1							+ 0 = any BCC + 2 = BCC not control character
Transmission stop by RTS		2							+ 0 = inactive + 4 = active
Transmission stop by DC3		3							+ 0 = inactive + 8 = active
Character parity even / odd		4							+ 0 = even + 16 = odd
Character parity on / off		5							+ 0 = off + 32 = on
Number of stop bits		6 7							+ 64 → bit 6 = 1 + 128 → bit 7 = 1 bit 6 bit 7 0 1 = 1½ stop bits 1 0 = 2 stop bits 0 1 = 1 stop bit 1 1 = 1 stop bit
Transfer mode for EXT EXT1 EXT2 EXT3 (PLC)	5030 5030.0* 5030.1* 5030.2*	105 05 05 -	108 08 08 -	- ♦ ♦ ♦	- ♦ ♦ ♦	- ♦ ♦ ♦	- ♦ ♦ ♦		0 = "Standard data transfer" 1 = "Blockwise transfer"

* Accessible via code number 123

Function	MP No.	Bit	A	B	C	D	E	F	Input
Data transfer rate for PLC coupling (EXT3)	5040		-	-	*	*	*	*	0 ... 9 0 = 110 Bd 5 = 2400 Bd 1 = 150 Bd 6 = 4800 Bd 2 = 300 Bd 7 = 9600 Bd 3 = 600 Bd 8 = 19200 Bd 4 = 1200 Bd 9 = 38400 Bd
Control characters for "Blockwise transfer"									
ASCII character for start of program									0 ... 127
EXT 1 (STX)	5200.0*		05	08	*	*	*	*	
EXT 2	5200.1*		05	08	*	*	*	*	
EXT3 (PLC)	5200.2*		-	-	*	*	*	*	
ASCII character for end of program									0 ... 127
for EXT1 (ETX)	5201.0*		05	08	*	*	*	*	
for EXT2	5201.1*		05	08	*	*	*	*	
for EXT3 (PLC)	5201.2*		-	-	*	*	*	*	
ASCII character for file type for data input									0 ... 127
for EXT1	5202.0*		05	08	*	*	*	*	
for EXT2	5202.1*		05	08	*	*	*	*	
for EXT3 (PLC)	5202.2*		-	-	*	*	*	*	
ASCII character for input code									0 ... 127
for EXT1 (E)	5203.0*		05	08	*	*	*	*	
for EXT2	5203.1*		05	08	*	*	*	*	
for EXT3 (PLC)	5203.2*		-	-	*	*	*	*	
ASCII character for file type for data output									0 ... 127
for EXT1	5204.0*		05	08	*	*	*	*	
for EXT2	5204.1*		05	08	*	*	*	*	
for EXT3 (PLC)	5204.2*		-	-	*	*	*	*	
ASCII character for output code									0 ... 127
for EXT1 (A)	5205.0*		05	08	*	*	*	*	
for EXT2	5205.1*		05	08	*	*	*	*	
for EXT3 (PLC)	5205.2*		-	-	*	*	*	*	
ASCII character for start of command block									0 ... 127
for EXT1 (SOH)	5206.0*		05	08	*	*	*	*	
for EXT2	5206.1*		05	08	*	*	*	*	
for EXT3 (PLC)	5206.2*		-	-	*	*	*	*	
ASCII character for end of command block									0 ... 127
for EXT1 (ETB)	5207.0*		05	08	*	*	*	*	
for EXT2	5207.1*		05	08	*	*	*	*	
for EXT3 (PLC)	5207.2*		-	-	*	*	*	*	
ASCII character for positive acknowledge									0 ... 127
for EXT1 (ACK)	5208.0*		05	08	*	*	*	*	
for EXT2	5208.1*		05	08	*	*	*	*	
for EXT3 (PLC)	5208.2*		-	-	*	*	*	*	
ASCII character for negative acknowledge									0 ... 127
EXT1 (NAK)	5209.0*		05	08	*	*	*	*	
EXT2	5209.1*		05	08	*	*	*	*	
EXT3 (PLC)	5209.2*		-	-	*	*	*	*	
ASCII character for end of transmission									0 ... 127
EXT1 (EOT)	5210.0*		05	08	*	*	*	*	
EXT2	5210.1*		05	08	*	*	*	*	
EXT3 (PLC)	5210.2*		-	-	*	*	*	*	

* Accessible via code number 123

6.6.3 Description of the machine parameters of TNC 415 B/425

Machine parameters

The following list contains the machine parameters for all software variants. Since however, several machine parameters are only valid for a certain software or have been introduced or eliminated as of a certain software version, there are columns with symbols for differentiation.

Meaning of the symbols:

- ◆ = The machine parameter applies for all software versions of this control.
- 04** = The machine parameter has been introduced with a certain software version (e.g. with version 04).
- I04** = The machine parameter is inactive.
- = The parameter does not exist on this control.

Explanation of the columns:

- A = TNC 415/B/F/BR/FR and TNC 425/E with NC software 259 93* – or 259 94* –
- B = TNC 415/B/F/BR/FR and TNC 425/E with NC software 280 54* – or 280 56* – (special software)
- C = for future use

Function	MP No.	Bit	A	B	Input
Inhibiting a data interface	5000		♦	♦	0 = no interface inhibited 1 = RS-232 inhibited 2 = RS-422 inhibited
Data format and transmission stop for the operating mode EXT1 for the operating mode EXT2 for the operating mode EXT3 (PLC)	5020.0* 5020.1* 5020.2*		♦ ♦ ♦	♦ ♦ ♦	0 ... 255
7 or 8 data bits		0			+ 0 = 7 data bits, bit 8 = parity + 1 = 8 data bits, bit 8 = 0 and bit 9 = parity
Block check character		1			+ 0 = any BCC + 2 = BCC not control character
Transmission stop by RTS		2			+ 0 = inactive + 4 = active
Transmission stop by DC3		3			+ 0 = inactive + 8 = active
Character parity even / odd		4			+ 0 = even + 16 = odd
Character parity on / off		5			+ 0 = off + 32 = on
Number of stop bits		6 7			+ 64 → bit 6 = 1 +128 → bit 7 = 1 bit 6 bit 7 0 1 = 1½ stop bits 1 0 = 2 stop bits 0 1 = 1 stop bit 1 1 = 1 stop bit
Transfer mode for EXT1 EXT2 EXT3 (PLC)	5030.0* 5030.1* 5030.2*		♦ ♦ ♦	♦ ♦ ♦	0 = "Standard data transfer" 1 = "Blockwise transfer"
Data transfer rate for PLC coupling (EXT3)	5040		♦	♦	0 ... 9 0 = 110 Bd 5 = 2400 Bd 10 = 57600 Bd 1 = 150 Bd 6 = 4800 Bd 11 = 115200 Bd 2 = 300 Bd 7 = 9600 Bd 3 = 600 Bd 8 = 19200 Bd 4 = 1200 Bd 9 = 38400 Bd
Control character for "Blockwise transfer" ASCII character for start of program EXT 1 (STX) EXT 2 EXT 3 (PLC)	5200.0* 5200.1* 5200.2*		♦ ♦ ♦	♦ ♦ ♦	0 ... 127
ASCII character for end of program for EXT1 (ETX) for EXT2 for PLC	5201.0* 5201.1* 5201.2*		♦ ♦ ♦	♦ ♦ ♦	0 ... 127
ASCII character for file type for data input for EXT1 for EXT2 for PLC	5202.0* 5202.1* 5202.2*		♦ ♦ ♦	♦ ♦ ♦	0 ... 127

Function	MP No.	Bit	A	B	Input
ASCII character for input code for EXT1 (E) for EXT2 for PLC	5203.0* 5203.1* 5203.2*		♦ ♦ ♦	♦ ♦ ♦	0 ... 127
ASCII character for file type for data output for EXT1 for EXT2 for EXT3 (PLC)	5204.0* 5204.1* 5204.2*		♦ ♦ ♦	♦ ♦ ♦	0 ... 127
ASCII character for output code for EXT1 (A) for EXT2 for EXT3 (PLC)	5205.0* 5205.1* 5205.2*		♦ ♦ ♦	♦ ♦ ♦	0 ... 127
ASCII character for start of command block for EXT1 (SOH) for EXT2 for EXT3 (PLC)	5206.0* 5206.1* 5206.2*		♦ ♦ ♦	♦ ♦ ♦	0 ... 127
ASCII character for end of command block for EXT1 (ETB) for EXT2 for EXT3 (PLC)	5207.0* 5207.1* 5207.2*		♦ ♦ ♦	♦ ♦ ♦	0 ... 127
ASCII character for positive acknowledge for EXT1 (ACK) for EXT2 for EXT3 (PLC)	5208.0* 5208.1* 5208.2*		♦ ♦ ♦	♦ ♦ ♦	0 ... 127
ASCII character for negative acknowledge EXT1 (NAK) EXT2 EXT3 (PLC)	5209.0* 5209.1* 5209.2*		♦ ♦ ♦	♦ ♦ ♦	0 ... 127
ASCII character for end of transmission EXT1 (EOT) EXT2 EXT3 (PLC)	5210.0* 5210.1* 5210.2*		♦ ♦ ♦	♦ ♦ ♦	0 ... 127

* Accessible via code number 123

6.7 Machine Parameters for TNC 426/430

6.7.1 Overview

Function	TNC					
	426	430				
Inhibiting a data interface	5000	5000				
Data format and transmission stop for the operating mode EXT1	5020.0	5020.0				
for the operating mode EXT2	5020.1	5020.1				
for the operating mode EXT3 (PLC)	5020.2	5020.2				
Transfer mode for EXT1	5030.0	5030.0				
EXT2	5030.1	5030.1				
EXT3 (PLC)	5030.2	5030.2				
Data transfer rate for PLC coupling (EXT3)	5040	5040				

6.7.2 Description of the machine parameters

Function	MP No.	Bit	A	B	C	D	Input
Inhibiting a data interface	5000	♦					0 = no interface inhibited 1 = RS-232 inhibited 2 = RS-422 inhibited
Data format and transmission stop for the operating mode EXT1 for the operating mode EXT2 for the operating mode EXT3 (PLC)	5020.0* 5020.1* 5020.2*	♦ ♦ ♦					0 ... 255
7 or 8 data bits	0						+ 0 = 7 data bits, bit 8 = parity + 1 = 8 data bits, bit 8 = 0 and bit 9 = parity
Block check character	1						+ 0 = any BCC + 2 = BCC not control character
Transmission stop by RTS	2						+ 0 = inactive + 4 = active
Transmission stop by DC3	3						+ 0 = inactive + 8 = active
Character parity even / odd	4						+ 0 = even + 16 = odd
Character parity on / off	5						+ 0 = off + 32 = on
Number of stop bits	6 7						+ 64 → bit 6 = 1 +128 → bit 7 = 1 bit 6 bit 7 0 1 = 1½ stop bits 1 0 = 2 stop bits 0 1 = 1 stop bit 1 1 = 1 stop bit
Transfer mode for EXT1 EXT2 EXT3 (PLC)	5030.0* 5030.1* 5030.2*	♦ ♦ ♦					0 = "Standard data transfer" 1 = "Blockwise transfer"
Data transfer rate for PLC coupling (EXT3)	5040	♦					0 ... 9 0 = 110 Bd 5 = 2400 Bd 10 = 57600 Bd 1 = 150 Bd 6 = 4800 Bd 11 = 15200 Bd 2 = 300 Bd 7 = 9600 Bd 3 = 600 Bd 8 = 19200 Bd 4 = 1200 Bd 9 = 38400 Bd

* Accessible via code number 123

7 Ethernet Card (Option) in TNC 426/430 Controls

7.1 Installing the Ethernet Card



Danger to internal components!
When handling components that can be damaged by electrostatic discharge (ESD), observe the safety recommendations in EN 100 015. Use only antistatic packaging material. Be sure that the work station and the technician are properly grounded during installation.



Attention

The Ethernet kit may only be mounted by trained personnel.

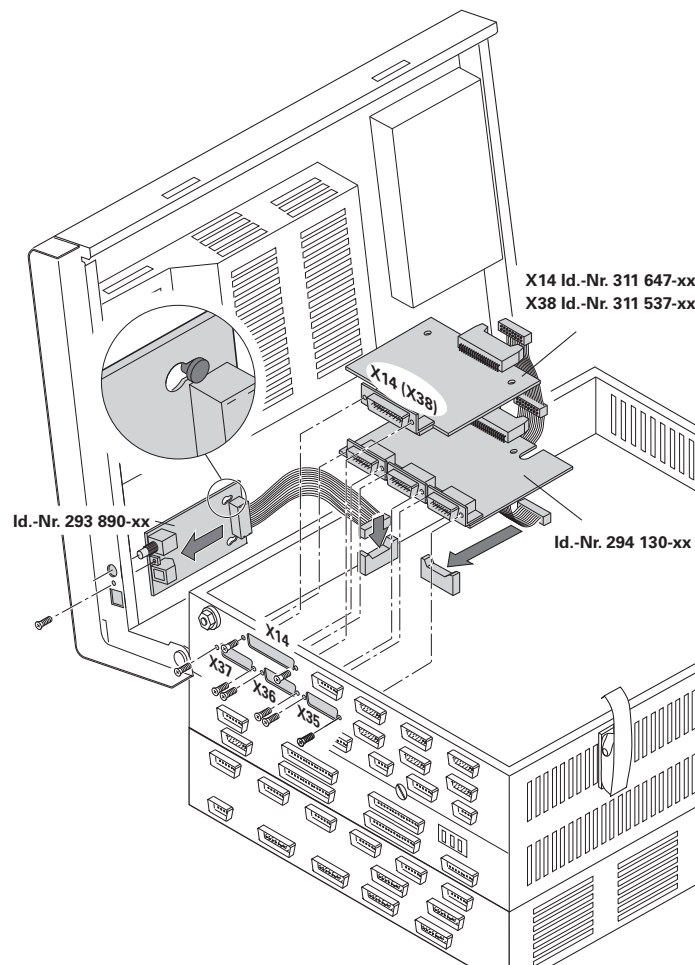

Function of the green LEDs on the ETHERNET board

- BS** (D1), **Bus Select**: Access to the Ethernet controller by the CPU of the TNC
This LED must blink when the control is started!
- LN** (D2), **Link**: Link signal received from server
- RX** (D3), **Received**: Data are received
- TX** (D4), **Transmitted**: Data are transmitted

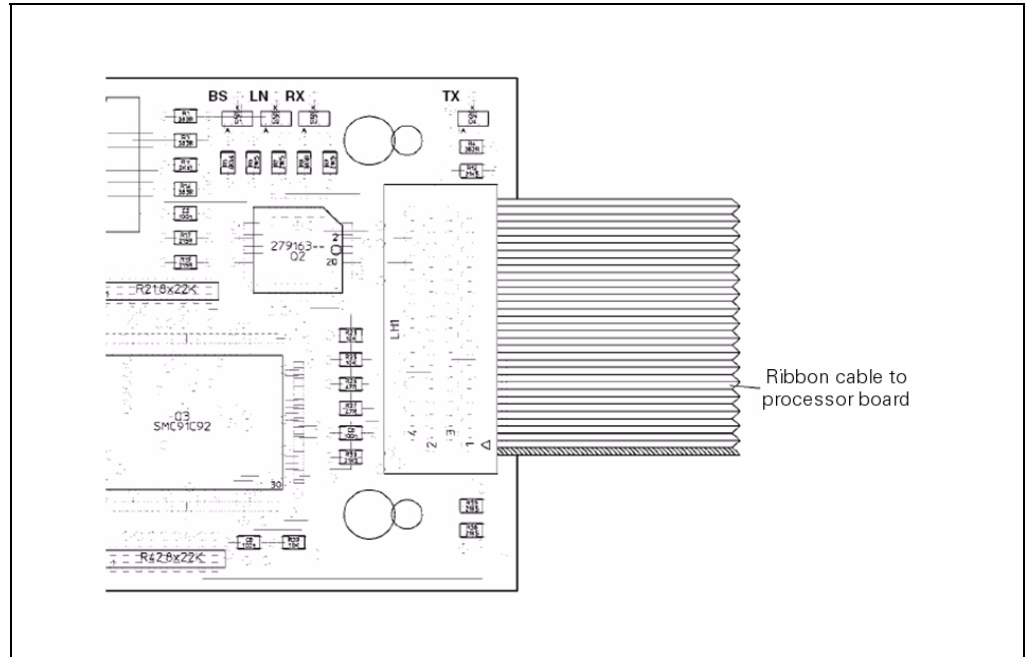

7.2 Connecting the Ethernet Hardware

X26, 10Base2

The maximum cable length is 185 m.

If longer cables are required, an additional amplifier must be used.

The minimum distance between two T-connectors is 0.5 m.

The number of T-connectors must not exceed 30.

Cable ends not in use must be terminated by 50 ohms resistors.

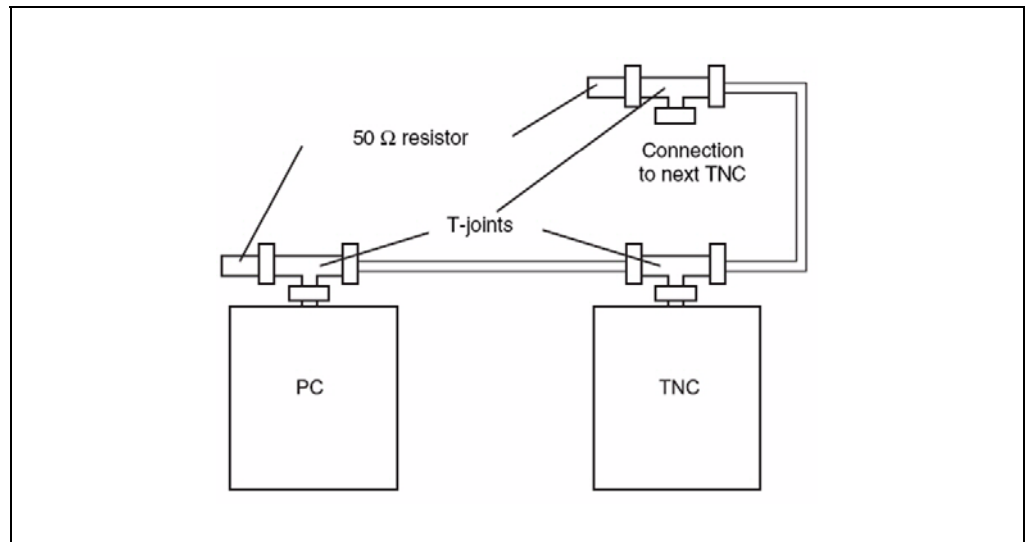

X25, 10BaseT

A transposed cable must be used to realize a direct connection from the computer to the TNC via 10BaseT.

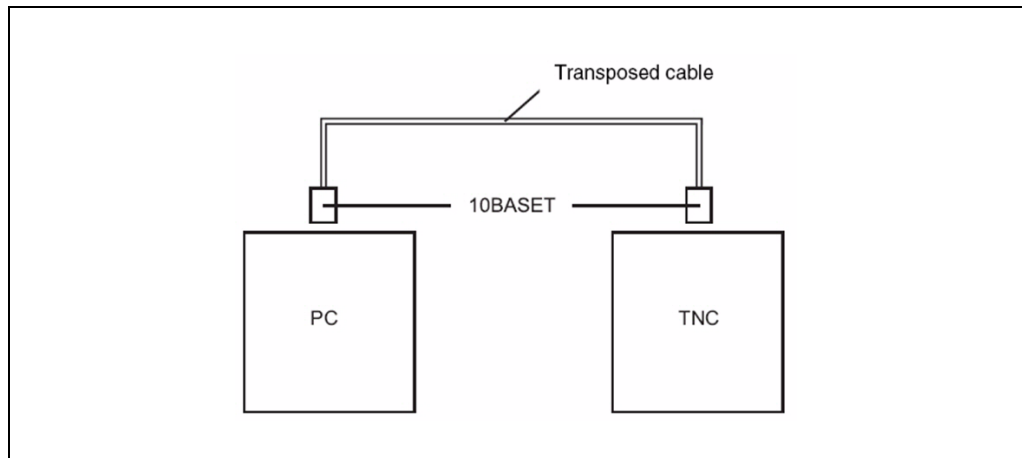

Pin layouts of 10Base2 and 10BaseT connections: see chapter 3.2

7.3 Ethernet Configuration in the TNC

7.3.1 Settings in DEFINE NET

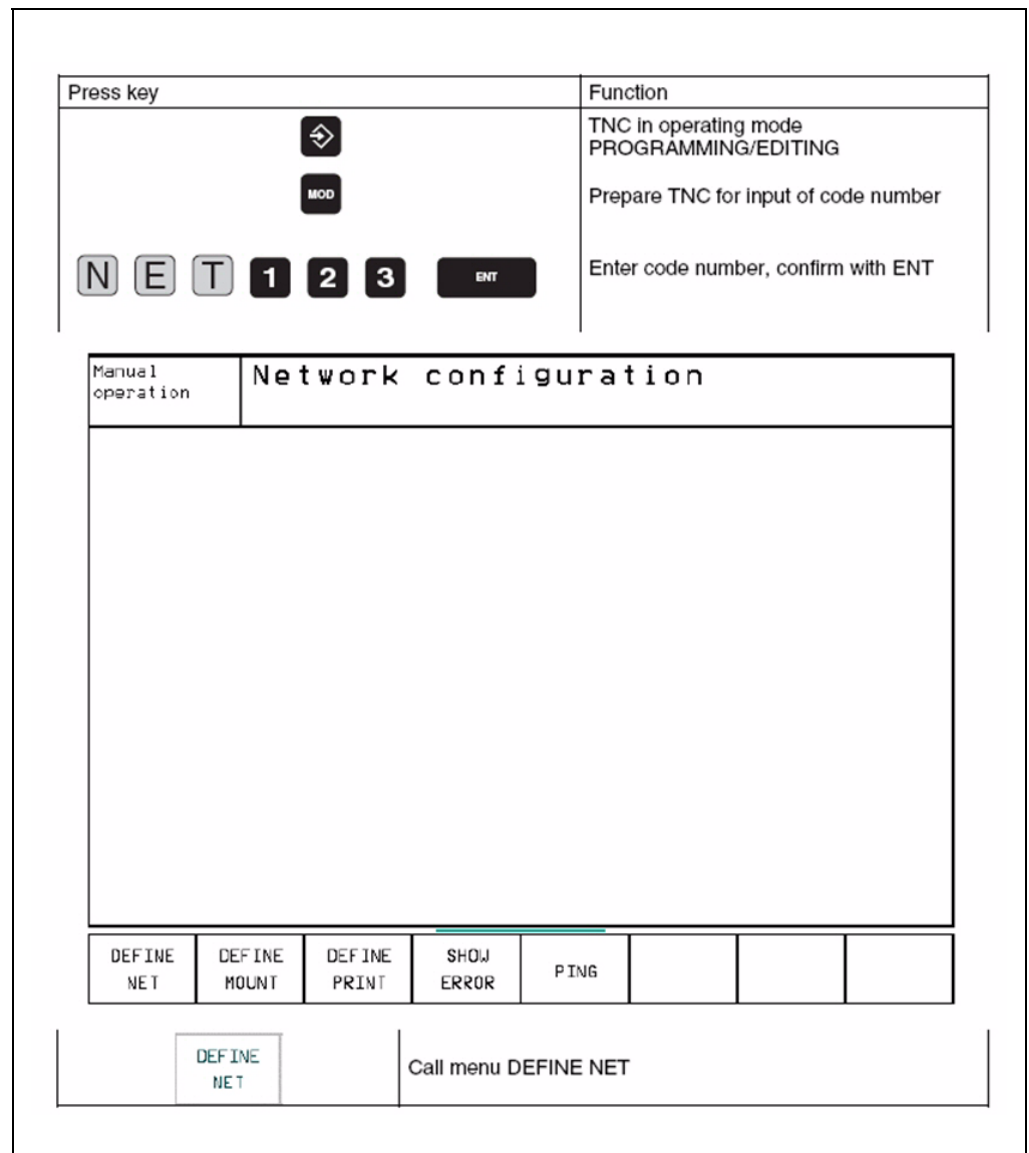

The following settings are made in DEFINE NET:

- ADDRESS:** ¹⁾ Information on the address of your TNC in the network (Internet).
- MASK:** ¹⁾ SUBNET MASK to "save" addresses in the network.
- ROUTER:** ¹⁾ ROUTER addresses only have to be specified, if a branch into another network level is required to reach the SERVER.
- PROT:** ¹⁾ Here the format for data transfer is specified (RFC in most cases).
- HW:** Hardware configuration of the connection: 10BaseT (twisted pair)
10Base2 (COAX)

HOST: ¹⁾ As of NC software 280 472 and 280 473!
 Here the name is entered under which the control registers itself at the SERVER.

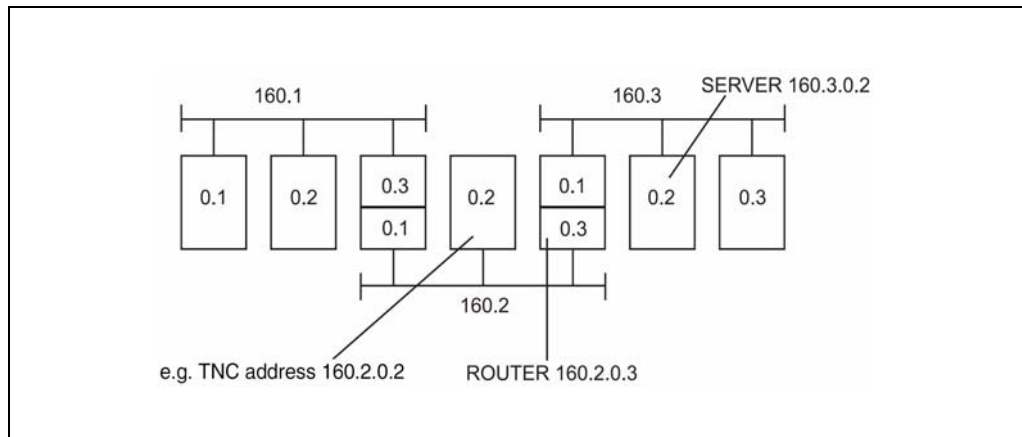

The boxes represent for example TNC controls or personal computers. Please note that a TNC can never be a ROUTER, since it does not feature the second connection for feeding signals through.

¹⁾ This information can be provided by your network specialist!

On the next pages, please find an example of the settings listed above.

ADDRESS: ¹⁾ Information on the address of your TNC in the network (Internet).

Manual operation	Network configuration					
	Internet address of TNC					
File: IP4.N00 >>>						
NR	ADDRESS	MASK	ROUTER	PROT		
0	160.1.180.1	255.255.0.0		RFC		
[END]						
BEGIN ↑	END ↓	PAGE ↑	PAGE ↓			NEXT LINE
→			Switch to next column.			

MASK:¹⁾ SUBNET MASK to "save" addresses in the network.

Manual operation	Network configuration Subnet mask						
File: IP4.N00 >>							
NR	ADDRESS	MASK	ROUTER	PROT			
0	160.1.180.1	255.255.0.0		RFC			
[END]							
BEGIN ↑	END ↓	PAGE ↑	PAGE ↓			NEXT LINE	
→ →							

¹⁾ This information can be provided by your network specialist!

PROT:¹⁾ Here the format for data transfer is specified (RFC in most cases).

Manual operation	Network configuration Protocol						
File: IP4.N00 >>							
NR	ADDRESS	MASK	ROUTER	PROT			
0	160.1.180.1	255.255.0.0		RFC			
[END]							
BEGIN ↑	END ↓	PAGE ↑	PAGE ↓			NEXT LINE	
→				Switch to next column.			

HW:¹⁾ Hardware configuration of the connection :10BaseT (twisted pair)
10Base2 (COAX)

Manual operation	Network configuration Connection (10BASET / 10BASE2)						
<<File: IP4.N00							
NR	PROT	HW	HOST				
0	RFC	10BASET					
[END]							
BEGIN ↑	END ↓	PAGE ↑	PAGE ↓			NEXT LINE	
END □				Exit menu.			

¹⁾ This information can be provided by your network specialist!

7.3.2 Settings in DEFINE MOUNT

Manual operation	Network configuration						
DEFINE NET	DEFINE MOUNT	DEFINE PRINT	SHOW ERROR	PING			
DEFINE MOUNT				Call menu DEFINE MOUNT.			

The following settings can be made in DEFINE MOUNT:

- ADDRESS:**¹⁾ Address (Internet address) of the server
- RS:**²⁾ Packet size for data input
- WS:**²⁾ Packet size for data output
- TIMEOUT:**¹⁾ A Remote Procedure Call that is not answered by the NFS server is repeated after expiration of the time defined here. 0 = 700 (standard)
- HM:** 1=YES / 0=NO: With a hard mount, the Remote Procedure Call is repeated until an answer is received from the NFS server. This has the advantage that after a server crash you can continue normal operation as soon as the server is up again. Use a soft mount (0) only, if the NFS server is not always available.
- DEVICENAME:** This name (TNC device name) is displayed in the TNC program management for the mounted network.
- PATH:** Directory path of the NFS server to be mounted, e.g.: world / home / test (input depends on the server software).
- DOMAIN:** Name used by the TNC to log onto the server. As of NC software 280 472 and 473 this information is not required.
- UID:**¹⁾ USER ID; identifies the user
- GID:**¹⁾ GROUP ID; identifies the group
- DCM** Directory create mode to define access rights to the directory for OWNER, GROUP and other USERS.
- PROT** As of NC software 280 472 and 473. The data transfer protocol is specified here, e.g. UDP.

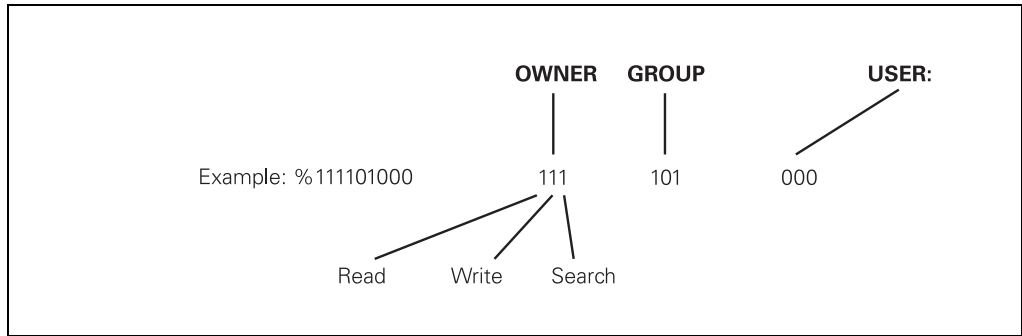

FCM FileCreateMode; here you assign access rights to files for OWNER, GROUP and other USERS.

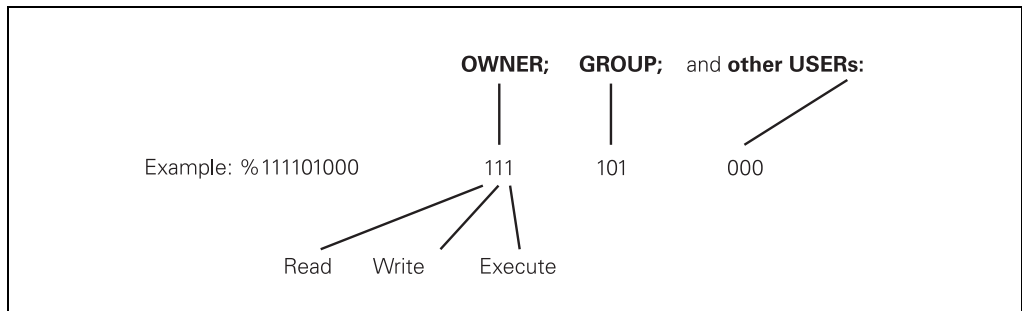

AM Here you can set, whether AUTOMOUNT is possible.

- 1) This information can be provided by your network specialist.
- 2) An entry of zero (standard) means that the optimum transfer size as indicated by the NFS server is used. Do not enter any other input values unless you have encountered throughput problems. Input range: 512 - 4096 bytes

On the next pages, please find an example of the settings listed above.

ADDRESS:¹⁾ Address (Internet address) of the server

Manual operation	Network configuration Internet address of server						
File: IP4.M00 >>							
NR	ADDRESS	RS	WS	TIMEOUT	HM	DEVICENAME	
0	160.1.13.4	0	0	0	1	WORLD	
[END]							
BEGIN ↑	END ↓	PAGE ↑	PAGE ↓	INSERT LINE	DELETE LINE	NEXT LINE	
→ → → →							

HM: 1=YES / 0=NO

Manual operation	Network configuration Hard mount (Yes=1 / No=0)						
File: IP4.M00 >>							
NR	ADDRESS	RS	WS	TIMEOUT	HM	DEVICENAME	
0	160.1.13.4	0	0	0	1	WORLD	
[END]							
BEGIN ↑	END ↓	PAGE ↑	PAGE ↓	INSERT LINE	DELETE LINE	NEXT LINE	
→				Switch to next column.			

¹⁾ This information can be provided by your network specialist!

DEVICENAME: This name is displayed in the TNC program management for the mounted network.

Manual operation	Network configuration						
	TNC device name						
File: IP4.M00							>>
NR	ADDRESS	RS	US	TIMEOUT	HM	DEVICENAME	
0	160.1.13.4	0	0	0	1	WORLD	
[END]							
BEGIN	END	PAGE	PAGE	INSERT	DELETE	NEXT	
↑	↓	↑	↓	LINE	LINE	LINE	
→				Switch to next column.			

PATH: Directory path, e.g.: world / home / test (input depends on the server software).

Manual operation	Network configuration						
	Directory						
<<File: IP4.M00							>>
NR	PATH			UID	GID		
0	world			100	100		
[END]							
BEGIN	END	PAGE	PAGE	INSERT	DELETE	NEXT	
↑	↓	↑	↓	LINE	LINE	LINE	
→				Switch to next column.			

DOMAIN: Name used by the TNC to log onto the server.
As of NC software 280 472 and 473 this information is not required.

REF.PUNKTE ÜBERFAHREN	NETZWERK-EINSTELLUNG						
DOMAINNAME							
<pre> <<DATEI: IP4.M00 NR DOMAIN UID GID 0 tnc02 100 100 [END] </pre>							
BEGIN TABLE	END TABLE	PAGE ↓	PAGE ↑	INSERT LINE	DELETE LINE	NEXT LINE	
				Switch to next column.			

UID:¹⁾ USER ID; identifies the user

Manual operation	Network configuration					
User id						
<pre> <<File: IP4.M00 NR UID GID DCM FCM AM 0 100 100 %111111111 %111111111 0 [END] </pre>						
BEGIN ↑	END ↓	PAGE ↑	PAGE ↓	INSERT LINE	DELETE LINE	NEXT LINE
				Switch to next column.		

¹⁾ This information can be provided by your network specialist!

GID:¹⁾ GROUP ID; identifies the group

Manual operation	Network configuration Group id						
<<File: IP4.M00							
NR	UID	GID	DCM	FCM	AM		
0	100	100	%1111111111	%1111111111	0		
[END]							
BEGIN ↑	END ↓	PAGE ↑	PAGE ↓	INSERT LINE	DELETE LINE	NEXT LINE	
→				Switch to next column.			

DCM Directory create mode to define access rights to the directory for OWNER, GROUP and other USERS.

Manual operation	Network configuration Directory create mode						
<<File: IP4.M00							
NR	UID	GID	DCM	FCM	AM		
0	100	100	%1111111111	%1111111111	0		
[END]							
BEGIN ↑	END ↓	PAGE ↑	PAGE ↓	INSERT LINE	DELETE LINE	NEXT LINE	
→				Switch to next column.			

¹⁾ This information can be provided by your network specialist!

FCM File create mode to define access rights to the files for OWNER, GROUP and other USERS.

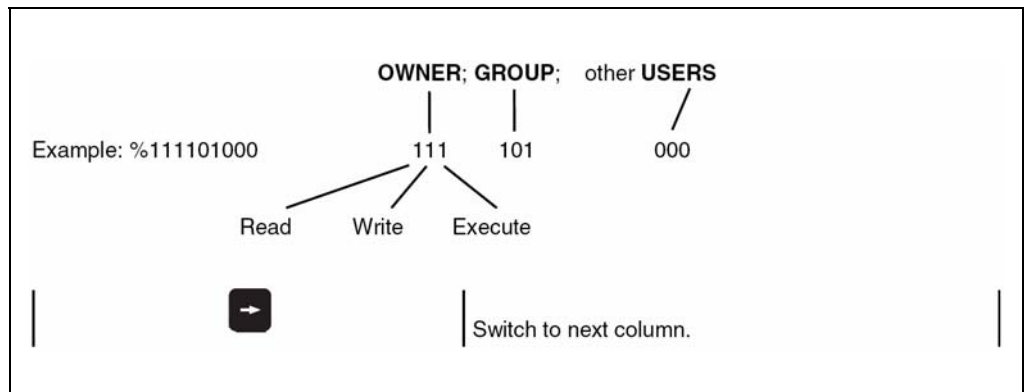

AM: Here you can set, whether AUTOMOUNT is possible.

Manual operation	Network configuration					
	Auto mount (Yes=1 / No=0)					
<pre><<File: IP4.M00</pre>						
NR	UID	GID	DCM	FCM	AM	
0	100	100	%1111111111	%1111111111	1	
[END]						
BEGIN ↑	END ↓	PAGE ↑	PAGE ↓	INSERT LINE	DELETE LINE	NEXT LINE
<input type="checkbox"/> END <input type="checkbox"/> END				Exit menu.		

After configuring the interface, switch the control off and on again to activate the data in the control.

7.4 Checking the Connection to the Server

Press key	Function
	TNC in operating mode PROGRAMMING/EDITING
	Prepare TNC for input of code number
N E T M O N I	Enter code number (as of NC software 280 472: NET123)
	and confirm input
	Press soft key (NC 280 470 / 471 only)
	Press soft key

As INTERNET ADDRESS enter the address stored in DEFINE MOUNT ADDRESS.

	Enter address
	Confirm input



Manual operation	Network configuration
PING MONITOR	
INTERNET ADDRESS : 160.1.13.4	
TRY 142 : HOST RESPOND	

The TNC now transmits a cyclic signal (ping) to the server and waits for confirmation. The number of attempts and the status of the confirmation is displayed in the line TRY xx : yy.

xx: Number of attempts
yy: Status: TIMEOUT ⇒ no connection
 HOST RESPOND ⇒ properly connected

		Exit menu
--	--	-----------

7.5 Finding the Hardware Address of the Ethernet Card





Press key	Function
  N E T M O N I  <div style="border: 1px solid black; padding: 2px; width: fit-content; margin: 5px auto;">INTERFACE</div> <div style="border: 1px solid black; padding: 2px; width: fit-content; margin: 5px auto;">INTERFACE 1</div>	TNC in operating mode PROGRAMMIING/EDITING Prepare TNC for input of code number Enter code number and confirm input Press soft key Press soft key

The hardware address of the Ethernet card is now displayed on the screen:
 INTERFACE IS ETHERNET XX:XX:XX:XX:XX:XX.

Manual operation	Network status							
	INTERFACE 1 INTERFACE NAME: ETH_1 INTERFACE IS ETHERNET 00:A0:CD:00:01:24 INTERFACE IS ACTIVE ARP IS IN USE INTERNET ADDRESS: 160.1.180.1							
<div style="display: flex; justify-content: space-around;"> <div style="border: 1px solid black; padding: 2px;">END □</div> <div style="border: 1px solid black; padding: 2px;">END □</div> <div style="border: 1px solid black; padding: 2px;">END □</div> </div>	<table border="1" style="width: 100%; border-collapse: collapse;"> <tr> <td style="width: 15%;">STATUS</td> <td style="width: 15%;">ARP</td> <td style="width: 15%;"></td> <td style="width: 15%;"></td> <td style="width: 15%;"></td> <td style="width: 15%;"></td> <td style="width: 15%;"></td> </tr> </table>	STATUS	ARP					
STATUS	ARP							
	Exit menu							

7.6 Working with the Ethernet Interface

7.6.1 Establish network connection (mount)

Press key	Function
	TNC in operating mode PROGRAMMIING/EDITING
	Call program management
	Switch soft-key row
	Press soft key NET

Manual operation	Programming and editing										
<ul style="list-style-type: none"> RS232:\ RS422:\ TNC:\ TNC:\ <ul style="list-style-type: none"> DEMO EXAMPLES SEMINAR TEST1 	<table border="1"> <thead> <tr> <th>Mnt</th> <th>Auto</th> <th>Device</th> <th>ServerAdr</th> <th>ServerPath</th> </tr> </thead> <tbody> <tr> <td></td> <td></td> <td>WORLD</td> <td>160.1.13.4</td> <td>world</td> </tr> </tbody> </table>	Mnt	Auto	Device	ServerAdr	ServerPath			WORLD	160.1.13.4	world
Mnt	Auto	Device	ServerAdr	ServerPath							
		WORLD	160.1.13.4	world							
<table border="1"> <tr> <td>MOUNT DEVICE</td> <td>UNMOUNT DEVICE</td> <td>AUTO MOUNT</td> <td>NO AUTO MOUNT</td> <td></td> <td></td> <td></td> <td>END</td> </tr> </table>	MOUNT DEVICE	UNMOUNT DEVICE	AUTO MOUNT	NO AUTO MOUNT				END			
MOUNT DEVICE	UNMOUNT DEVICE	AUTO MOUNT	NO AUTO MOUNT				END				

The network line must be connected to the Ethernet card.

MOUNT
DEVICE

Establish connection

The letter M below Mnt shows that the device has been mounted.

Manual operation	Programming and editing								
<ul style="list-style-type: none"> RS232:\ RS422:\ TNC:\ TNC:\ <ul style="list-style-type: none"> DEMO EXAMPLES SEMINAR TEST1 	<table border="1" style="width: 100%; border-collapse: collapse;"> <thead> <tr> <th>Mnt</th> <th>Auto Device</th> <th>ServerAdr</th> <th>ServerPath</th> </tr> </thead> <tbody> <tr style="background-color: #e0f0ff;"> <td>M</td> <td>WORLD</td> <td>160.1.13.4</td> <td>world</td> </tr> </tbody> </table>	Mnt	Auto Device	ServerAdr	ServerPath	M	WORLD	160.1.13.4	world
Mnt	Auto Device	ServerAdr	ServerPath						
M	WORLD	160.1.13.4	world						
MOUNT DEVICE	UNMOUNT DEVICE	AUTO MOUNT	NO AUTO MOUNT	END					



On the left half of the screen the mounted drive is displayed; in the example:

WORLD:

Press key	Function
<div style="border: 1px solid black; padding: 5px; display: inline-block;">END</div> ... 	<p>Press soft key to exit the submenu</p> <p>Press arrow keys to select the network drive</p> <p>The directory ([READ DIR]) is loaded</p>

Manual operation	Programming and editing																																																																						
<ul style="list-style-type: none"> WORLD:\ RS232:\ RS422:\ TNC:\ 0123 4561 a10354 a11236 a11240 a7565 a7697 a7708 alois anz 	<table border="1" style="width: 100%; border-collapse: collapse;"> <thead> <tr> <th colspan="5">WORLD:*.*</th> </tr> <tr> <th>File name</th> <th>bytes</th> <th>Status</th> <th>date</th> <th>Time</th> </tr> </thead> <tbody> <tr><td>19200</td><td>.</td><td>1512</td><td>03-12-1997</td><td>14:33:56</td></tr> <tr><td>a7687</td><td>.</td><td>56</td><td>28-11-1997</td><td>13:11:45</td></tr> <tr><td>A_KRANI</td><td>.</td><td>56206</td><td>03-12-1997</td><td>14:44:37</td></tr> <tr><td>casault1</td><td>.</td><td>848</td><td>28-11-1997</td><td>13:11:47</td></tr> <tr><td>dump_disk</td><td>.</td><td>4130</td><td>28-11-1997</td><td>13:11:50</td></tr> <tr><td>hp_catfile</td><td>.</td><td>2048</td><td>17-12-1996</td><td>12:11:06</td></tr> <tr><td>hp_catlock</td><td>.</td><td>0</td><td>17-12-1996</td><td>12:11:16</td></tr> <tr><td>reinhold_</td><td>.</td><td>145</td><td>03-12-1997</td><td>14:42:56</td></tr> <tr><td>RIERO</td><td>.</td><td>36</td><td>03-12-1997</td><td>14:44:37</td></tr> <tr><td>rs</td><td>.</td><td>7057</td><td>03-12-1997</td><td>14:42:56</td></tr> <tr><td>rxxxxxxx</td><td>.</td><td>65536</td><td>19-11-1997</td><td>16:21:07</td></tr> <tr><td colspan="5">135 file(s) 83405 kbyte vacant</td></tr> </tbody> </table>	WORLD:*.*					File name	bytes	Status	date	Time	19200	.	1512	03-12-1997	14:33:56	a7687	.	56	28-11-1997	13:11:45	A_KRANI	.	56206	03-12-1997	14:44:37	casault1	.	848	28-11-1997	13:11:47	dump_disk	.	4130	28-11-1997	13:11:50	hp_catfile	.	2048	17-12-1996	12:11:06	hp_catlock	.	0	17-12-1996	12:11:16	reinhold_	.	145	03-12-1997	14:42:56	RIERO	.	36	03-12-1997	14:44:37	rs	.	7057	03-12-1997	14:42:56	rxxxxxxx	.	65536	19-11-1997	16:21:07	135 file(s) 83405 kbyte vacant				
WORLD:*.*																																																																							
File name	bytes	Status	date	Time																																																																			
19200	.	1512	03-12-1997	14:33:56																																																																			
a7687	.	56	28-11-1997	13:11:45																																																																			
A_KRANI	.	56206	03-12-1997	14:44:37																																																																			
casault1	.	848	28-11-1997	13:11:47																																																																			
dump_disk	.	4130	28-11-1997	13:11:50																																																																			
hp_catfile	.	2048	17-12-1996	12:11:06																																																																			
hp_catlock	.	0	17-12-1996	12:11:16																																																																			
reinhold_	.	145	03-12-1997	14:42:56																																																																			
RIERO	.	36	03-12-1997	14:44:37																																																																			
rs	.	7057	03-12-1997	14:42:56																																																																			
rxxxxxxx	.	65536	19-11-1997	16:21:07																																																																			
135 file(s) 83405 kbyte vacant																																																																							
PAGE ↑	PAGE ↓	SELECT 	COPY DIR 	SELECT TYPE 	WINDOW 	LAST FILES 	END																																																																

7.6.2 Unmounting a network connection

Press key	Function
   <div style="border: 1px solid black; padding: 5px; width: fit-content; margin: 10px auto;">NET</div>	TNC in operating mode PROGRAMMING/EDITING Call program management Switch soft-key row Press soft key NET

Manual operation	Programming and editing										
<ul style="list-style-type: none"> RS232:\ RS422:\ TNC:\ TNC:\ <ul style="list-style-type: none"> DEMO EXAMPLES SEMINAR TEST1 	<table border="1" style="width: 100%; border-collapse: collapse;"> <thead> <tr> <th style="width: 10%;">Mnt</th> <th style="width: 15%;">Auto</th> <th style="width: 20%;">Device</th> <th style="width: 20%;">ServerAdr</th> <th style="width: 35%;">ServerPath</th> </tr> </thead> <tbody> <tr style="background-color: #008080; color: white;"> <td>M</td> <td></td> <td>WORLD</td> <td>160.1.13.4</td> <td>world</td> </tr> </tbody> </table>	Mnt	Auto	Device	ServerAdr	ServerPath	M		WORLD	160.1.13.4	world
Mnt	Auto	Device	ServerAdr	ServerPath							
M		WORLD	160.1.13.4	world							
<table border="1" style="width: 100%; border-collapse: collapse;"> <tr> <td style="width: 12.5%;">MOUNT DEVICE</td> <td style="width: 12.5%;">UNMOUNT DEVICE</td> <td style="width: 12.5%;">AUTO MOUNT</td> <td style="width: 12.5%;">NO AUTO MOUNT</td> <td style="width: 12.5%;"></td> <td style="width: 12.5%;"></td> <td style="width: 12.5%;"></td> <td style="width: 12.5%;"></td> <td style="width: 12.5%; text-align: right;">END</td> </tr> </table>		MOUNT DEVICE	UNMOUNT DEVICE	AUTO MOUNT	NO AUTO MOUNT					END	
MOUNT DEVICE	UNMOUNT DEVICE	AUTO MOUNT	NO AUTO MOUNT					END			

The network line must now be disconnected from the Ethernet card.

<div style="border: 1px solid black; padding: 5px; width: fit-content; margin: 0 auto;">UNMOUNT DEVICE</div> <div style="border: 1px solid black; padding: 5px; width: fit-content; margin: 10px auto;">END</div>	Disconnect Press soft key to exit the submenu
---	--

8 Error Messages and their Causes

8.1 Error Messages Related to the RS-232C and RS-422 Interfaces

8.1.1 Error messages at the TNC in the ME mode

WRONG OPERATING MODE

No operating mode or wrong operating mode set on the external data medium.

FAULTY PROGRAM DATA

Wrong or faulty program data have been detected during data transfer. The control attempted three times to read from the magnetic tape before aborting the process.

DATA MEDIUM MISSING

No cassette has been inserted into the drive.

DATA MEDIUM EMPTY

No programs are stored on the data medium (cassette).

DATA MEDIUM WRITE-PROTECTED

The write-enable plug in the cassette is missing.

PROGAM INCOMPLETE

Data transfer was aborted before the program was completely loaded.

EXT. IN/OUTPUT NOT READY

The DSR signal is missing at the TNC.

- ME not connected
- Transmission cable defective or incorrect
- Wrong interface assignment

ME: TAPE END

The cassette is full. To continue data transfer, turn over or exchange the cassette.

8.1.2 Error messages at the ME

In the ME, the electronics is tested and the external operating conditions are checked. If an error is detected, the lamps of the operating mode display start blinking. In the table below the error types are listed:

- LED off
- * LED blinks

Indicator lamps	Error message
○○○* ○○○○	Faulty data during transfer
○○*○ ○○○○	No cassette inserted
○○** ○○○○	Write-enable plug in cassette is missing
○*○○ ○○○○	Wrong operating mode selected
○*○* ○○○○	Data of magnetic tape faulty
○**○ ○○○○	Magnetic tape empty
*○○○ ○○○○	Error in ME electronics
○○	
○○	
*○**	
**○○	
**○*	
**** ○○○○	End of tape
○*** ○○○○	Peripheral unit is not connected
**○* ○○○○	Data transfer between TNC and ME or peripheral interrupted by 

Pressing  clears the error messages.

8.1.3 Error messages at the FE in the ME mode

In the ME mode, errors are displayed by the indicator lamps (LEDs) of the control buttons blinking.

- LED off
- LED on
- * LED blinks

Indicator lamps	Error message
○○○● ○*○○	Disk is missing or error in the electronics
○○○* ○*○○	Disk cannot be formatted, as it is currently being used
*○○● *○○○	Disk is missing or not formatted
○○ *○○○	Disk cannot be copied, as a read/write process is active
●○*● ○○○○	External device not ready or not connected
*○●● ○○○○	Disk is missing or not formatted
*○○● ○○●○	Disk is missing or not formatted or no program is available
○● ○○○○	Program cannot be output, as data transfer via the TNC interface is in process
○○ ○○●○	Program cannot be output, as data transfer via the PRT interface is in process
○○*● ●○○○	External device not ready or not connected
○○●● *○○○	Disk is missing or not formatted
○○○● *○○○	Disk is missing or not formatted
○○●* *○○○	Program cannot be output, as data transfer via the TNC interface is in process
○○○* *○○○	Program cannot be output, as data transfer via the PRT interface is in process
○●○● ○○*○	External device not ready or not connected
○*○● ○○●○	Disk is missing or error in the electronics
○*○* ○○●○	Table of contents cannot be output, as data transfer via the PRT interface is in process.

○○○* ○○●○	No interface coupling is possible, as data transfer via the TNC interface is in process
○○●* ○○○○	No interface coupling is possible, as data transfer via the PRT interface is in process
○○*● ○○○○	External device not ready or not connected

Pressing  clears the error messages.

8.1.4 Error messages at the TNC in the FE mode

In this operating mode, the floppy disk unit outputs errors in the following format:

(SOH) ERR: (SP) (SP) (SP) [XXX] (ETB) (BCC)
XXX = Error number

The following errors may be displayed:

Input/Output Errors

ERR: 001 = Incorrect command code
ERR: 002 = Illegal program name
ERR: 003 = Faulty data transfer
ERR: 004 = Program incomplete
ERR: 005 = Receiving buffer overflow
ERR: 006 = Function currently disabled
ERR: 007 = Data-buffer overflow

Errors during Program Write or Read

ERR: 010 = Program not on disk
ERR: 011 = Program erase-protected
ERR: 012 = Program is being written to
ERR: 013 = Program directory is full
ERR: 014 = Disk is full
ERR: 015 = Text not found
ERR: 016 = Program name already exists
ERR: 017 = Disk access active
ERR: 018 = Program currently being read

Disk / Drive / Controller Errors

ERR: 100 = Disk not initialized
ERR: 101 = Sector number too large ¹⁾
ERR: 102 = Drive not ready ²⁾
ERR: 103 = Disk is write-protected
ERR: 104 = Faulty data on disk ¹⁾
ERR: 105 = Sector cannot be found ¹⁾
ERR: 106 = Check sum is incorrect ¹⁾
ERR: 107 = Disk controller defective ³⁾
ERR: 108 = DMA error ³⁾
ERR: 109 = Disk exchanged during program loading

- 1) These error messages indicate that the disk is defective; in most cases, they can only be eliminated by reformatting the disk.
- 2) If this error message comes up while the disk is inserted, the drive is probably defective.
- 3) Hardware defect

8.1.5 Error messages during data transfer

TRANSFERRED VALUE INCORRECT X

X =	A	Faulty character frame
	B	Character overflow
	C	Faulty character frame or character overflow
	D	Parity error
	E	Faulty character frame or parity error
	F	Character overflow or parity error
	G	Faulty character frame or character overflow or parity error
	H	Receiving buffer overflow
	K	Incorrect ESC sequence (only in "ME" mode)
	L	Incorrect ESC sequence (only in "ME" mode)

DATA TRANSFER ERRONEOUS X

X =	A	Faulty character frame
	D	Parity error
	M	The control has received the character for "Negative Acknowledgement" (NAK) more than 3 times
	N	The control has transmitted the character for "Negative Acknowledgement" (NAK) more than 3 times
	P	Timeout ACK/NAK

BAUD RATE NOT POSSIBLE

If both data interfaces (RS 232/RS 422) are active simultaneously, the baud rate of both data interfaces must be the same.

INTERFACE ALREADY ASSIGNED

A data interface cannot be used for two operating modes at a time (e.g. DNC mode and simultaneous programming is not possible with one data interface).

EXT. IN/OUTPUT NOT READY

- DSR signal missing at the TNC
- Transmission cable defective or incorrect
- Wrong interface assignment

PROGAM INCOMPLETE

Data transfer was aborted before the program was completely loaded.

8.2 Ethernet Error Messages

Error messages or warnings that are generated when a device is mounted, are stored in plain language in an ERROR file.

When the control is switched off and on, the contents of this file is **deleted**.

The entries in this file can be viewed by entering the code number "**NET123**" and pressing the soft key "**SHOW ERROR**".

Structure of an Error Message

A message starts with the program part that detected the error; this element is terminated by a colon. Then the name of the device to be mounted can follow in <> angle brackets. The software differentiates between errors (**E**) and warnings (**W**). In the event of an error the network cannot be activated and the device cannot be mounted. When a warning is generated, the network could be activated or the device mounted, however, inappropriate entry values were corrected.

Errors reported by the link layer:

LL: (W) CONNECTION "error string" UNKNOWN USING DEFAULT 10BASE2

An unknown name was entered for the connection.
10BASE2 (Thin Ethernet) is used.

LL: (E) PROTOCOL "error string" UNKNOWN

An unknown name was entered for the protocol.

Errors detected by the network layer:

IP4: (E) INTERFACE NOT PRESENT

The Ethernet card could not be found.

IP4: (E) INTERNET ADDRESS NOT VALID

The control was assigned an invalid Internet address; e.g. a class D or E address, a loop-back address or a broadcast address.

IP4: (E) SUBNETMASK NOT VALID

The specified subnet mask does not match the Internet address, or only 1 bit was provided for the subnet ID or the host ID.

IP4: (E) SUBNETMASK OR HOST ID NOT VALID

Input of Internet address or subnet mask faulty, or all bits of the host ID are 0 or 1.

IP4: (E) SUBNET MASK OR SUBNET ID NOT VALID

All bits of the SUBNET ID are 0 or 1.

IP4: (E) DEFAULTROUTERADDRESS NOT VALID

For the default router an invalid Internet address was entered; e.g. a class D or E address, a loop-back address or a broadcast address.

IP4: (E) CANNOT USE DEFAULT ROUTER

The net ID and the subnet ID of the default router are not identical to those of the control.

IP4: (E) I AM NOT A ROUTER

The Internet address of the default router is identical to that of the control.

Errors detected by the mount system call:

MOUNT: <Device name> (E) DEVICENAME NOT VALID

The device name is either too long or it contains illegal characters.

MOUNT: <Device name> (E) DEVICENAME ALREADY ASSIGNED

A device with the same name already exists

MOUNT: <Device name> (E) DEVICETABLE OVERFLOW

The device table is full; the device cannot be mounted any more.

Errors and warnings generated by the network file system, version 2:

NFS2: <Device name> (W) READSIZE SMALLER THEN x SET TO x

The selected read size is too small; it is set to the smallest permissible value.

NFS2: <Device name> (W) READSIZE LARGER THEN x SET TO x

The selected read size is too large; it is set to the highest permissible value.

NFS2: <Device name> (W) WRITESIZE SMALLER THEN x SET TO x

The selected write size is too small; it is set to the smallest permissible value.

NFS2: <Device name> (W) WRITESIZE LARGER THEN x SET TO x

The selected write size is too large; it is set to the highest permissible value.

NFS2: <Device name> (E) MOUNTPATH TOO LONG

The specified mount path is too long; the device cannot be mounted.

NFS2: <Device name> (E) NOT ENOUGH MEMORY

The memory available for the driver is insufficient to provide the management data for the device.

NFS2: <Device name> (E) HOSTNAME TOO LONG

The specified host name is too long; the device cannot be mounted.

NFS2: <Device name> (E) CANNOT OPEN PORT

A port required for mounting cannot be opened.

NFS2: <Device name> (E) ERROR FROM PORTMAPPER

The data received from the port mapper are not plausible, or no data were received.

NFS2: <Device name> (E) ERROR FROM MOUNTSERVER

The data received from the mount server are not plausible, or no data were received.

NFS2: <Device name> (E) CANT GET ROOTDIRECTORY

The mount server does not permit the mounting of the specified directory.

NFS2: <Device name> (E) UID OR GID 0 NOT ALLOWED

User ID 0 and group ID 0 are not permitted; they may exclusively be used by the super user or the system administrator.

9 Tables

9.1 7-Bit ASCII Code

Character	Decimal	Octal	Hexadecimal
NUL	000	000	00
SOH	001	001	01
STX	002	002	02
ETX	003	003	03
EOT	004	004	04
ENQ	005	005	05
ACK	006	006	06
BEL	007	007	07
BS	008	010	08
HT	009	011	09
LF	010	012	0A
VT	011	013	0B
FF	012	014	0C
CR	013	015	0D
SO	014	016	0E
SI	015	017	0F
DLE	016	020	10
DC1 (X-ON)	017	021	11
DC2	018	022	12
DC3 (X-OFF)	019	023	13
DC4	020	024	14
NAK	021	025	15
SYN	022	026	16
ETB	023	027	17
CAN	024	030	18
EM	025	031	19
SUB	026	032	1A
ESC	027	033	1B
FS	028	034	1C
GS	029	035	1D
RS	030	036	1E
US	031	037	1F

Character	Decimal	Octal	Hexadecimal
SP	032	040	20
!	033	041	21
"	034	042	22
#	035	043	23
\$	036	044	24
%	037	045	25
&	038	046	26
'	039	047	27
(040	050	28
)	041	051	29
*	042	052	2A
+	043	053	2B
,	044	054	2C
-	045	055	2D
.	046	056	2E
/	047	057	2F
0	048	060	30
1	049	061	31
2	050	062	32
3	051	063	33
4	052	064	34
5	053	065	35
6	054	066	36
7	055	067	37
8	056	070	38
9	057	071	39
:	058	072	3A
;	059	073	3B
<	060	074	3C
=	061	075	3D
>	062	076	3E
?	063	077	3F
@	064	100	40
A	065	101	41
B	066	102	42
C	067	103	43

Character	Decimal	Octal	Hexadecimal
D	068	104	44
E	069	105	45
F	070	106	46
G	071	107	47
H	072	110	48
I	073	111	49
J	074	112	4A
K	075	113	4B
L	076	114	4C
M	077	115	4D
N	078	116	4E
O	079	117	4F
P	080	120	50
Q	081	121	51
R	082	122	52
S	083	123	53
T	084	124	54
U	085	125	55
V	086	126	56
W	087	127	57
X	088	130	58
Y	089	131	59
Z	090	132	5A
[091	133	5B
\	092	134	5C
]	093	135	5D
^	094	136	5E
_	095	137	5F
`	096	140	60
a	097	141	61
b	098	142	62
c	099	143	63
d	100	144	64
e	101	145	65
f	102	146	66
g	103	147	67

Character	Decimal	Octal	Hexadecimal
h	104	150	68
i	105	151	69
j	106	152	6A
k	107	153	6B
l	108	154	6C
m	109	155	6D
n	110	156	6E
o	111	157	6F
p	112	160	70
q	113	161	71
r	114	162	72
s	115	163	73
t	116	164	74
u	117	165	75
v	118	166	76
w	119	167	77
x	120	170	78
y	121	171	79
z	122	172	7A
{	123	173	7B
	124	174	7C
}	125	175	7D
~	126	176	7E
DEL	127	177	7F

9.2 Powers of 2

n	2ⁿ
0	1
1	2
2	4
3	8
4	16
5	32
6	64
7	128
8	256
9	512
10	1 024
11	2 048
12	4 096
13	8 192
14	16 384
15	32 768
16	65 536
17	131 072
18	262 144
19	524 288
20	1 048 576

HEIDENHAIN

DR. JOHANNES HEIDENHAIN GmbH

Dr.-Johannes-Heidenhain-Straße 5

83301 Traunreut, Germany

☎ +49 (86 69) 31-0

FAX +49 (86 69) 50 61

E-mail: info@heidenhain.de

www.heidenhain.com

The **HEIDENHAIN Helpline** in Traunreut consist of qualified, multi-lingual specialists who support you in solving your problems.

Especially if you need **technical support** the HEIDENHAIN Helpline team can provide detailed advice and information on measuring systems, controls as well as NC and PLC programming.

Your **HEIDENHAIN Helpline:**

TNC support

☎ +49 (8669) 31-3101

E-mail: service.nc-support@heidenhain.de

PLC programming TNC

☎ +49 (8669) 31-3102

E-mail: service.plc@heidenhain.de

TNC programming

☎ +49 (8669) 31-3103

E-mail: service.nc-pgm@heidenhain.de

Measuring systems / machine measurement

☎ +49 (8669) 31-3104

E-mail: service.ms-support@heidenhain.de

Lathe controls

☎ +49 (86) 31-3105

E-mail: service.hsf@heidenhain.de

Service order processing

Domestic team

☎ +49 (8669) 31-3121

Foreign team

☎ +49 (8669) 31-3123

E-mail: service.order@heidenhain.de

Service coordination

Complaints and returned goods team

☎ +49 (8669) 31-3135

E-mail: service.order@heidenhain.de

Documentation

E-mail: service.docu@heidenhain.de

Technical training

☎ +49 (8669) 31-2293, 31-1695

FAX +49 (86 69) 31-1999

E-mail: mtt@heidenhain.de

