

MITSUBISHI

**MELDAS AC SERVO
MDS-C1-V1/V2**

SERVO ADJUSTMENT MANUAL (For M640)

BNP-A2993-87-A(ENG)

SERVO ADJUSTMENT MANUAL For M640

18/DEC/2000 NC System Dept.

Outline

This manual describes how to adjust MDS-C1-V1/V2 (High gain mode) and MDS-CH-V1/V2 on M640. Refer to MDS-C1 Series SPECIFICATIONS MANUAL BNP-C3000*(ENG) or MDS-CH Series SPECIFICATIONS MANUAL BNP-C3016A(ENG) for details.

1. Auxiliary axis setting	3
2. Current loop gain setting	4
3. Speed loop gain setting	5
4. Acceleration/Deceleration time constant setting	12
5. Position loop gain setting	16
6. Vertical axis setting	22
7. Lost motion compensation setting	23
8. Machine end compensation setting (Machining center)	25
9. Collision detection setting (NC lathe)	27
Standard parameter list by each motor	30
Report on adjustment result of the servo used for the first time	32
Check sheet for speed gain adjustment	34

Servo Adjustment Flow Chart

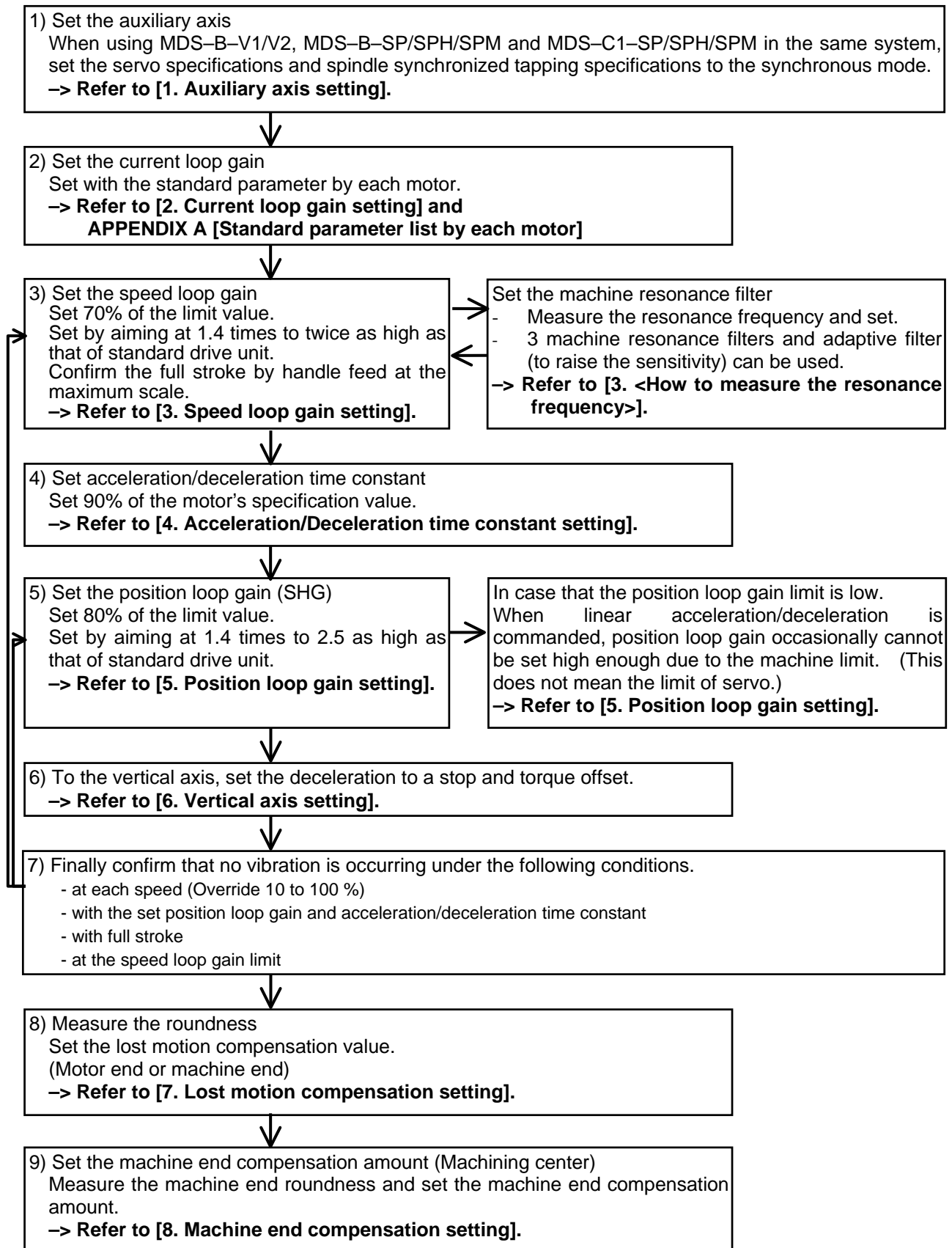

1. Auxiliary axis setting

To perform interpolation (including synchronized tapping) with MDS-C1-V1/V2 (High gain mode) in case the other models of drive unit are used in the same system, **parameters of the axis to perform the interpolation with has to be changed.**

Especially, when performing synchronized tapping with the spindle drive unit (MDS-B-SP/SPH/SPM/SPJ2, C1-SP), make sure to set as follows.

(1) Models of drive unit that can perform the interpolation with MDS-C1-V1/V2 (High gain mode)

-Servo drive unit

B-V1/V2	B-V14/V24	C1-V1/V2 (Standard mode)	C1-V1/V2 (High gain mode)	B-SVJ2
*	O	*	O	X

-Spindle drive unit

B-SP/SPH/SPM	C1-SP/SPH/SPM	C1-SP4/SP4M	B-SPJ2
*	*	O	*

O: No problem with standard settings

* : Available only when the parameters are set as follows

X: Not available (Possible to drive individually, however, synchronous accuracy is not guaranteed.)

[Note] Only when the communication cycle with NC is 3.5ms, B-SPJ2 is applicable.

(2) MDS-B-V1/V2, MDS - C1 - V1/V2 (Standard mode)

No.	Abbrev.	Parameter name	Explanation																																								
SV017	SPEC	Servo specifications	<p>To synchronize with MDS-C1-V1/V2 (High gain mode), set to the synchronization mode with the following parameter.</p> <table border="1" style="margin-left: 20px;"> <tr> <td>15</td><td>14</td><td>13</td><td>12</td><td>11</td><td>10</td><td>9</td><td>8</td><td>7</td><td>6</td><td>5</td><td>4</td><td>3</td><td>2</td><td>1</td><td>0</td> </tr> <tr> <td colspan="12"></td> <td>spwv</td> <td colspan="4"></td> </tr> </table> <table border="1" style="margin-left: 20px; width: 100%;"> <thead> <tr> <th>bit</th> <th>Meaning when "0" is set</th> <th>Meaning when "1" is set</th> </tr> </thead> <tbody> <tr> <td>3</td> <td>spwv</td> <td>Synchronization with MDS-B-V14/V24 is disabled.</td> <td>Synchronization with MDS-B-V14/V24 is enabled.</td> </tr> </tbody> </table>	15	14	13	12	11	10	9	8	7	6	5	4	3	2	1	0													spwv					bit	Meaning when "0" is set	Meaning when "1" is set	3	spwv	Synchronization with MDS-B-V14/V24 is disabled.	Synchronization with MDS-B-V14/V24 is enabled.
15	14	13	12	11	10	9	8	7	6	5	4	3	2	1	0																												
												spwv																															
bit	Meaning when "0" is set	Meaning when "1" is set																																									
3	spwv	Synchronization with MDS-B-V14/V24 is disabled.	Synchronization with MDS-B-V14/V24 is enabled.																																								

The applicable software versions are; MDS-B-V1/V2 → Ver.AD and later versions

MDS-C1-V1/V2 (Standard mode) → Ver.A1 and later versions

(3)MDS-B-SP/SPH/SPM/SPJ2, MDS-C1-SP/SPH/SPM

No.	Abbrev.	Parameter name	Explanation																																									
SP193	SPECT	Spindle specifications during synchronized tapping	<p>To synchronize with MDS-C1-V1/V2 (High gain mode), set to the synchronization mode with the following parameter.</p> <table border="1" style="margin-left: 20px;"> <tr> <td>15</td><td>14</td><td>13</td><td>12</td><td>11</td><td>10</td><td>9</td><td>8</td><td>7</td><td>6</td><td>5</td><td>4</td><td>3</td><td>2</td><td>1</td><td>0</td> </tr> <tr> <td></td><td></td><td></td><td></td><td></td><td></td><td></td><td>phos</td><td></td><td></td><td></td><td></td><td></td><td></td><td></td><td></td> </tr> </table> <table border="1" style="margin-left: 20px;"> <thead> <tr> <th>bit</th> <th>Meaning when "0" is set</th> <th>Meaning when "1" is set</th> </tr> </thead> <tbody> <tr> <td>8</td> <td>phos</td> <td>Synchronization with MDS-B-V14/V24 is disabled..</td> </tr> <tr> <td></td> <td></td> <td>Synchronization with MDS-B-V14/V24 is enabled.</td> </tr> </tbody> </table>	15	14	13	12	11	10	9	8	7	6	5	4	3	2	1	0								phos									bit	Meaning when "0" is set	Meaning when "1" is set	8	phos	Synchronization with MDS-B-V14/V24 is disabled..			Synchronization with MDS-B-V14/V24 is enabled.
15	14	13	12	11	10	9	8	7	6	5	4	3	2	1	0																													
							phos																																					
bit	Meaning when "0" is set	Meaning when "1" is set																																										
8	phos	Synchronization with MDS-B-V14/V24 is disabled..																																										
		Synchronization with MDS-B-V14/V24 is enabled.																																										

The applicable software versions are;

- MDS-B-SP → Ver.AE
- MDS-B-SPH → Ver.B4 and later versions
- MDS-B-SPM → Ver.A0 and later versions
- MDS-B-SPJ2 → Ver.A8 and later versions
- MDS-C1-SP/SPH/SPM → Ver.A0 and later versions

2. Current loop gain setting

Set the current loop gain of the standard parameters by each motor.

SV009 (IQA)	4096
SV010 (IDA)	4096
SV011 (IQG)	768
SV012 (IDG)	768

(The above table is an example of HC motor.)

3. Speed loop gain setting

Set the speed loop gain by taking account of the individual differences of each machine as follows. Confirm that no resonance sound is occurring when performing the following operations.

- Handle feed (full stroke)
- Rapid traverse feed 25, 50, 100%
- Cutting feed 10 to 100%

(1) Measure the machine resonance frequency
Measure the machine resonance frequency with a check pin etc.
-> Write the result in the check sheet.

(2) Set the 1st machine resonance filter
Set the machine resonance suppression filter to the maximum ($-\infty$ dB), and confirm the speed loop gain limit at that time. Only when the low-frequency resonance (50 to 150Hz) occurs, however, make the filter depth shallower.

If the filter is set deeply in case that the resonance frequency is close to the speed loop band (up to 300Hz), the response at the low-frequency is suppressed. Thus, set the depth with care when using 2 machine resonance suppression filters.

(3) Secure the resonance margin
Confirm that the set frequency is optimum by lowering and raising the set resonance filter frequency at the depth that is set in procedure (2). Confirm also the speed loop gain limit of each frequency. Determine the lowest speed loop gain limit as the speed loop gain limit of this machine.
-> Write the result in the check sheet.

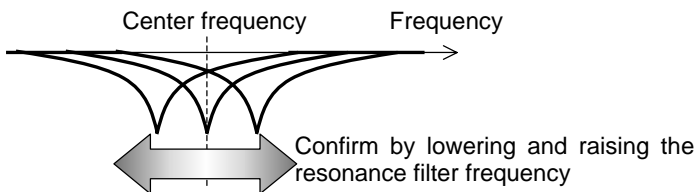

As shown below, confirm the range about the point at which the speed loop gain limit reaches the maximum.
In the flowing example, set 550.

The set frequency	409	450	500	562
Speed gain limit	550	650	600	550

Determine the lowest speed loop gain limit

Confirm the range about the point at which the speed loop

(4) Set the second machine resonance suppression filter
Set the second machine resonance suppression filter after confirming the same way. -> Write the result in the check sheet.

(5) Set the adaptive filter
Set the adaptive filter and confirm the speed loop gain limit.
-> Write the result in the check sheet.

Set this to suppress the resonance which was not confirmed when the machine was adjusted. The unconfirmed resonance may occur under the different installation or work condition.

(6) Determine the setting value of the speed loop gain
Set 70% of the speed loop gain limit that was determined by carrying out the procedures from (1) to (5). (Completed)
->Write the result in the check sheet.

<How to measure the resonance frequency>

Calculate the resonance frequency with the **analogue current waveform** of a check pin card etc.

- Check pin card 7 pins – L axis U-phase current FB
 17 pins – L axis V-phase current FB
 6 pins – M axis U-phase current FB
 16 pins – M axis V-phase current FB

[Note1] The resonance frequency cannot be judged correctly with the waveform of D/A output, as its sampling cycle is too long.

[Note2] Set the speed loop gain (SV005) to about 50 to 100, and measure without the resonance filter.

- (SV033 bit0 to 7 -> xx00
 SV038, SV046 -> 0
 SV027 -> 4xxx)

Example of resonance frequency measurement

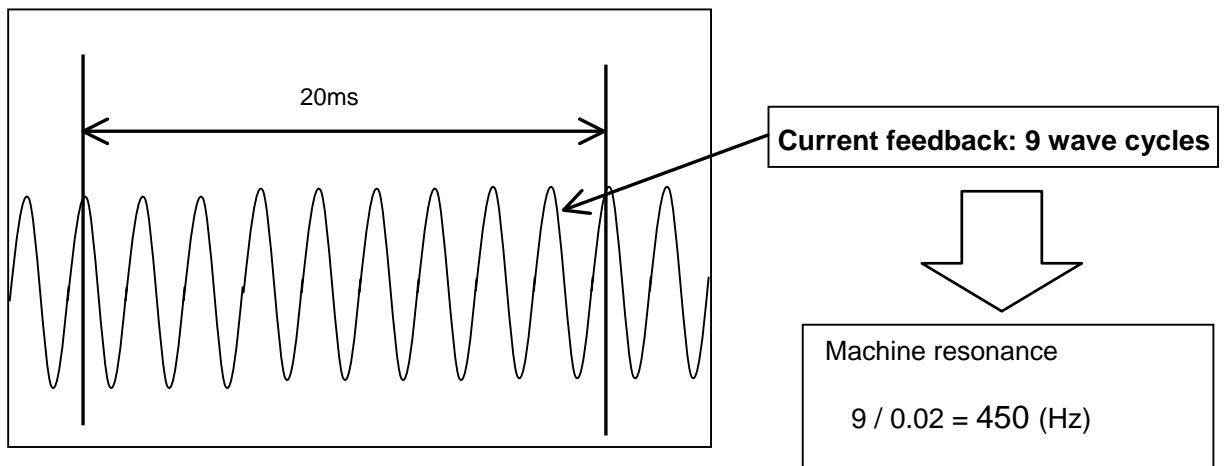

[Note3] Measure the phase current while stopping. During the axis movement, the AC element of the phase current exists.

<Secure the resonance margin>

To confirm the speed loop gain limit, the setting filter frequency is lowered and raised by 1 to steps, at this time, confirm the following frequency as well.

(Example) In case of setting to 450Hz

- (1) Set to 409Hz and 500Hz and confirm that the speed loop gain limit is the maximum at 450Hz.
- (2) In this case, set the filter frequency to 409, 450 and 500Hz and determine the lowest speed loop gain limit as the speed loop gain limit of this machine.

Machine resonance suppression filter frequency to be confirmed

70Hz	173Hz	375Hz	818Hz
80Hz	187Hz	409Hz	900Hz
90Hz	204Hz	450Hz	1000Hz
100Hz	225Hz	500Hz	1125Hz
112Hz	250Hz	562Hz	1285Hz
125Hz	281Hz	600Hz	1500Hz
132Hz	300Hz	642Hz	1800Hz
150Hz	321Hz	692Hz	2250Hz
160Hz	346Hz	750Hz	-

<How to set the machine resonance filter frequency in case that resonance cannot be eliminated>

Normally, 2 variable machine resonance filters equipped with MDS-C1-V1/V2 (High gain mode) are enough to suppress the machine resonance, however, some machines cause machine resonance at more than 3 points and it disables to suppress machine resonance completely. In this case, try the following methods.

(1) In case that the machine resonance occurs at more than 3 points and any of resonance is caused at more than 800Hz;

Set the 3rd machine resonance filter (SV033, bit4). By setting the 3rd machine resonance filter, the resonance filter is set at 1125Hz and the machine resonance at more than 800Hz can be suppressed. Eliminate the rest of machine resonance with the 1st and 2nd machine resonance filters.

In the same way, in case that the machine resonance at more than 800Hz is too large to eliminate with the 1st and 2nd machine filters even by setting 1st and 2nd machine filters to the resonance frequency, setting the 3rd machine resonance filter may work.

(Example) In case that the machine resonance at around 1100Hz is too strong to suppress even by setting the 1st machine resonance filter the most deeply, the machine resonance can be eliminated by setting the 1st machine resonance filter to 1125Hz and to the depth of about 6dB in combination with 3 machine resonance filter.

(2) In case that the machine resonance occurs at more than 3 points (Case1)

Eliminate the machine resonance at the highest frequency with an adaptive filter. Even in case that the machine resonance cannot be suppressed, the sensitivity is raised, therefore, set the adaptive filter by following the instruction. Eliminate the rest of the machine resonance with 1st and 2nd machine resonance filters.

(3) In case that the machine resonance occurs at more than 3 points (Case2)

The machine resonance filter of MDS-C1-V1/V2(High gain mode) can also be set to the frequency increased by odd-number times of the setting frequency. Thus, in case that one machine resonance is close to the frequency increased by the odd-number times of the other machine resonance, machine resonance at 2 points can be eliminated by setting the resonance filter frequency to the lower frequency and adjusting by 10 to 20Hz.

(Example) In case that the machine resonance occurs at 260Hz and 750Hz, the machine resonance at both frequency can be eliminated by setting the filter to 250Hz.

(4) In case that the machine resonance does not improved even after setting the machine resonance filter

The machine resonance filter frequency of MDS-C1-V1/V2 (high gain mode) cannot be set to the other frequency but to the frequency calculated by following expression only. Therefore, in case of no frequency to set to, machine resonance can be eliminated by setting to the frequency calculated by dividing by odd-number. (For example, one third.)

The settable machine resonance filter frequency (Hz) = $9000/N$ (N=4 to 128)

(Example) To set to 1400Hz, set to 470Hz so that the same effect can be obtained.

<How to adjust in case that the machine resonance occurs during high-speed revolution>

In case that the machine resonance during high-speed revolution is too strong, for example when using a detector with low-resolution, the accuracy can be raised **by enabling the variable speed loop gain function**.

With this variable speed loop gain;

- the speed loop gain during low-speed revolution is secured (the accuracy is improved.)
- machine resonance during high-speed revolution is suppressed

However, be aware that the vibration while accelerating/decelerating during high-speed revolution will be stronger as the speed loop gain is lowered.

[How to adjust] Refer to the following flow chart and adjust.

Fig1. Variable speed loop gain function adjustment

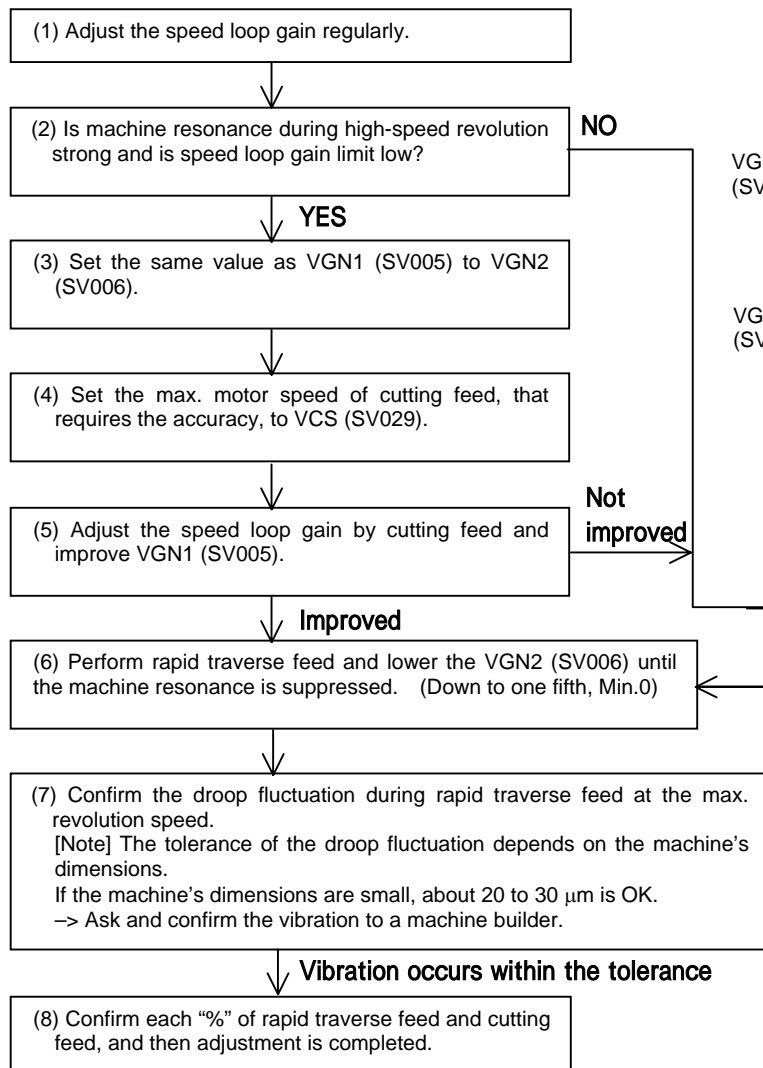
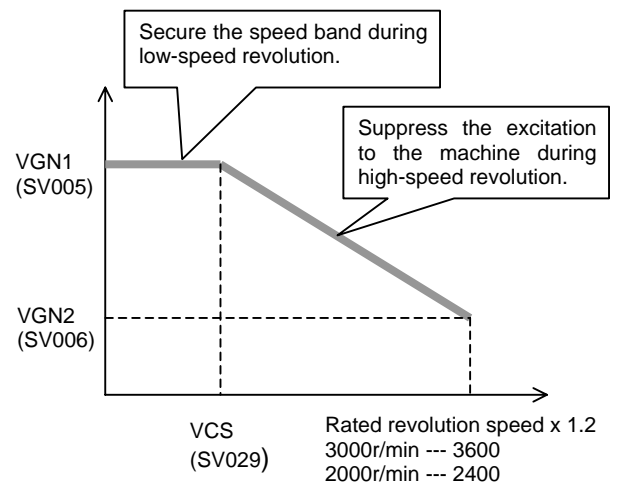

Fig2. Outline of variable speed loop gain function



How to set the variable speed loop gain function

No.	Abbrev.	Parameter name	Unit	Explanation	Setting range
SV005	VGN1	Speed loop gain during low-speed revolution	-	Set the speed loop gain. When setting higher value than the standard setting gain, responsiveness is improved, however, the vibration and noise becomes worse.	1 to 999
SV006	VGN2	Speed loop gain during high-speed revolution	-	Set the speed loop gain (smaller than VGN1) during high-speed revolution (1.2 time as fast as rated revolution). Set "0" when the filter is not to be used.	- 1000 to 1000
SV029	VCS	Motor speed at the start of revolution speed decrease	r/min	When the noise is too loud during high-speed revolution such as rapid traverse feed, set the motor speed at the start of revolution speed decrease. Set "0" when the filter is not to be used.	0 to 9999 (r/min)

How to set the machine resonance filter in MDS-C1-V1/V2 (High gain mode)

No.	Abbrev.	Parameter name	Unit	Explanation	Setting range																																																
SV038	FHz1	Center frequency 1 of machine resonance suppression filter	Hz	Set the resonance frequency to be suppressed. (Available at 36 or more). Set "0" when the filter is not to be used.	0 to 9000 (Hz)																																																
SV046	FHz2	Center frequency 1 of machine resonance suppression filter	Hz	Set the resonance frequency to be suppressed. (Available at 36 or more). Set "0" when the filter is not to be used.	0 to 9000 (Hz)																																																
SV033	SSF2	Special servo function selection 2		<p>Set the compensation depth of machine resonance suppression filter with following parameter.</p> <table border="1" style="width: 100%; text-align: center;"> <tr> <td>15</td><td>14</td><td>13</td><td>12</td><td>11</td><td>10</td><td>9</td><td>8</td><td>7</td><td>6</td><td>5</td><td>4</td><td>3</td><td>2</td><td>1</td><td>0</td> </tr> <tr> <td colspan="4">dos</td> <td colspan="4">dis</td> <td colspan="2">nfd2</td> <td colspan="2">nfd3</td> <td colspan="2">nfd1</td> <td colspan="2">zck</td> </tr> </table> <table border="1" style="width: 100%; text-align: center;"> <thead> <tr> <th>bit</th> <th>Explanation</th> </tr> </thead> <tbody> <tr> <td>1</td> <td>Set the filter depth of the 1st machine resonance suppression filter. The control is stabilized by setting the filter shallowly enough to eliminate the vibration.</td> </tr> <tr> <td>to nfd1</td> <td>Deeper <- -> Shallower</td> </tr> <tr> <td>3</td> <td>Setting value 000 001 010 011 100 101 110 111 Depth (dB) -∞ -18 -12 -9 -6 -4 -3 -1</td> </tr> <tr> <td>4</td> <td>Enable the 3rd machine resonance suppression filter. (Center frequency 1125Hz)</td> </tr> <tr> <td>5</td> <td>Set the filter depth of the 2nd machine resonance suppression filter. The control is stabilized by setting the filter shallowly enough to eliminate the vibration.</td> </tr> <tr> <td>to nfd2</td> <td>Deeper <- -> Shallower</td> </tr> <tr> <td>7</td> <td>Setting value 000 001 010 011 100 101 110 111 Depth (dB) -∞ -18 -12 -9 -6 -4 -3 -1</td> </tr> </tbody> </table>	15	14	13	12	11	10	9	8	7	6	5	4	3	2	1	0	dos				dis				nfd2		nfd3		nfd1		zck		bit	Explanation	1	Set the filter depth of the 1st machine resonance suppression filter. The control is stabilized by setting the filter shallowly enough to eliminate the vibration.	to nfd1	Deeper <- -> Shallower	3	Setting value 000 001 010 011 100 101 110 111 Depth (dB) -∞ -18 -12 -9 -6 -4 -3 -1	4	Enable the 3rd machine resonance suppression filter. (Center frequency 1125Hz)	5	Set the filter depth of the 2nd machine resonance suppression filter. The control is stabilized by setting the filter shallowly enough to eliminate the vibration.	to nfd2	Deeper <- -> Shallower	7	Setting value 000 001 010 011 100 101 110 111 Depth (dB) -∞ -18 -12 -9 -6 -4 -3 -1	
15	14	13	12	11	10	9	8	7	6	5	4	3	2	1	0																																						
dos				dis				nfd2		nfd3		nfd1		zck																																							
bit	Explanation																																																				
1	Set the filter depth of the 1st machine resonance suppression filter. The control is stabilized by setting the filter shallowly enough to eliminate the vibration.																																																				
to nfd1	Deeper <- -> Shallower																																																				
3	Setting value 000 001 010 011 100 101 110 111 Depth (dB) -∞ -18 -12 -9 -6 -4 -3 -1																																																				
4	Enable the 3rd machine resonance suppression filter. (Center frequency 1125Hz)																																																				
5	Set the filter depth of the 2nd machine resonance suppression filter. The control is stabilized by setting the filter shallowly enough to eliminate the vibration.																																																				
to nfd2	Deeper <- -> Shallower																																																				
7	Setting value 000 001 010 011 100 101 110 111 Depth (dB) -∞ -18 -12 -9 -6 -4 -3 -1																																																				
SV017	SPEC	Servo specification		<p>Set speed feedback filter with following parameter.</p> <p>The feedback filter is efficient for the resonance which is more than 2250Hz.</p> <p>(The following parameter is added to MDS-C1-V1/V2 Ver.A1 and later versions)</p> <table border="1" style="width: 100%; text-align: center;"> <tr> <td>15</td><td>14</td><td>13</td><td>12</td><td>11</td><td>10</td><td>9</td><td>8</td><td>7</td><td>6</td><td>5</td><td>4</td><td>3</td><td>2</td><td>1</td><td>0</td> </tr> <tr> <td colspan="12"></td> <td colspan="2">Vfb</td> <td colspan="2"></td> </tr> </table> <table border="1" style="width: 100%; text-align: center;"> <thead> <tr> <th>bit</th> <th>Explanation</th> </tr> </thead> <tbody> <tr> <td>3</td> <td>Vfb</td> </tr> <tr> <td colspan="2">Speed feedback filter is enabled.</td> </tr> <tr> <td colspan="2">This is as effective as the machine resonance filter whose center frequency is more than 2250Hz.</td> </tr> </tbody> </table>	15	14	13	12	11	10	9	8	7	6	5	4	3	2	1	0													Vfb				bit	Explanation	3	Vfb	Speed feedback filter is enabled.		This is as effective as the machine resonance filter whose center frequency is more than 2250Hz.										
15	14	13	12	11	10	9	8	7	6	5	4	3	2	1	0																																						
												Vfb																																									
bit	Explanation																																																				
3	Vfb																																																				
Speed feedback filter is enabled.																																																					
This is as effective as the machine resonance filter whose center frequency is more than 2250Hz.																																																					

How to set the adaptive filter in MDS-C1-V1/V2 (High gain mode)

No.	Abbrev.	Parameter name	Explanation																																																											
SV027	SSF1	Special servo function selection 1	<p>Start the adaptive filter with following parameter.</p> <table border="1" style="width: 100%; text-align: center;"> <tr> <td>15</td><td>14</td><td>13</td><td>12</td><td>11</td><td>10</td><td>9</td><td>8</td><td>7</td><td>6</td><td>5</td><td>4</td><td>3</td><td>2</td><td>1</td><td>0</td> </tr> <tr> <td colspan="2">aflt</td> <td colspan="2">zm2</td> <td colspan="2">afrg</td> <td colspan="2">afse</td> <td colspan="2">ovs2</td> <td colspan="2">ovs1</td> <td colspan="2">lmc2</td> <td colspan="2">lmc1</td> <td colspan="2">omr</td> <td colspan="2">vft2</td> <td colspan="2">vft1</td> <td colspan="2">upc</td> <td colspan="2">vcnt2</td> <td colspan="2">vcnt1</td> </tr> </table> <table border="1" style="width: 100%; text-align: center;"> <thead> <tr> <th>bit</th> <th>Meaning when "0" is set.</th> <th>Meaning when "1" is set</th> </tr> </thead> <tbody> <tr> <td>15</td> <td>aflt</td> <td>Adaptive filter STOP</td> <td>Adaptive filter START</td> </tr> <tr> <td>13</td> <td>afrg</td> <td>00: Normal adaptive filter</td> <td>01: Up the adaptive filter</td> </tr> <tr> <td>12</td> <td>afse</td> <td>sensitivity</td> <td>sensitivity</td> </tr> </tbody> </table>	15	14	13	12	11	10	9	8	7	6	5	4	3	2	1	0	aflt		zm2		afrg		afse		ovs2		ovs1		lmc2		lmc1		omr		vft2		vft1		upc		vcnt2		vcnt1		bit	Meaning when "0" is set.	Meaning when "1" is set	15	aflt	Adaptive filter STOP	Adaptive filter START	13	afrg	00: Normal adaptive filter	01: Up the adaptive filter	12	afse	sensitivity	sensitivity
15	14	13	12	11	10	9	8	7	6	5	4	3	2	1	0																																															
aflt		zm2		afrg		afse		ovs2		ovs1		lmc2		lmc1		omr		vft2		vft1		upc		vcnt2		vcnt1																																				
bit	Meaning when "0" is set.	Meaning when "1" is set																																																												
15	aflt	Adaptive filter STOP	Adaptive filter START																																																											
13	afrg	00: Normal adaptive filter	01: Up the adaptive filter																																																											
12	afse	sensitivity	sensitivity																																																											

<Standard setting value of speed loop gain (SV005: VGN1) >

■ In case of MDS-C1-V1/V2 (High gain mode)

Determine the speed loop gain referring to the comparison graph shown below.

In case that the speed loop gain exceeds the standard speed gain value shown in the graph, some machine system easily cause the small vibration as the change of the current command becomes too large for the change of speed feedback by 1 pulse.

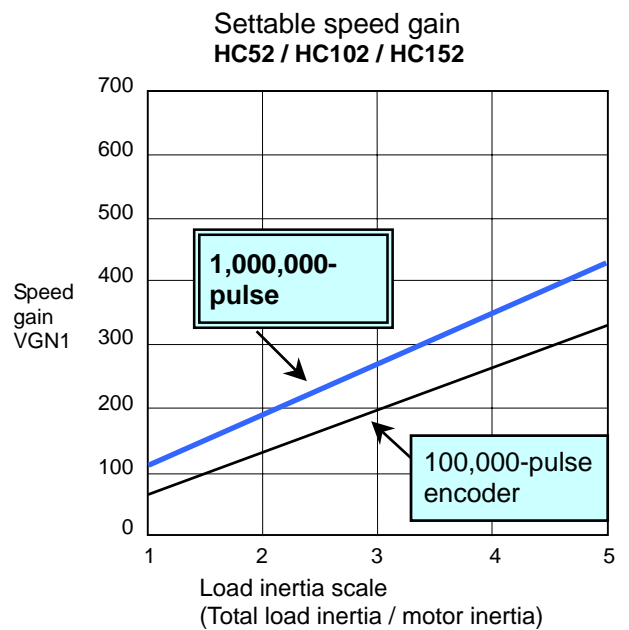
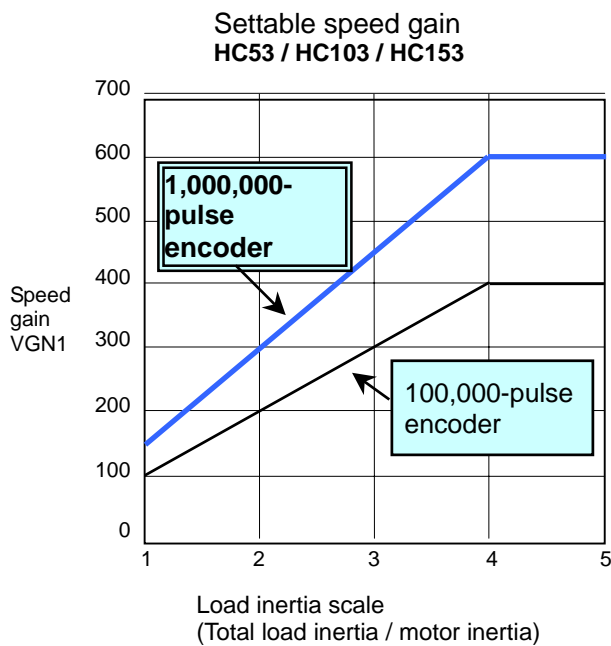
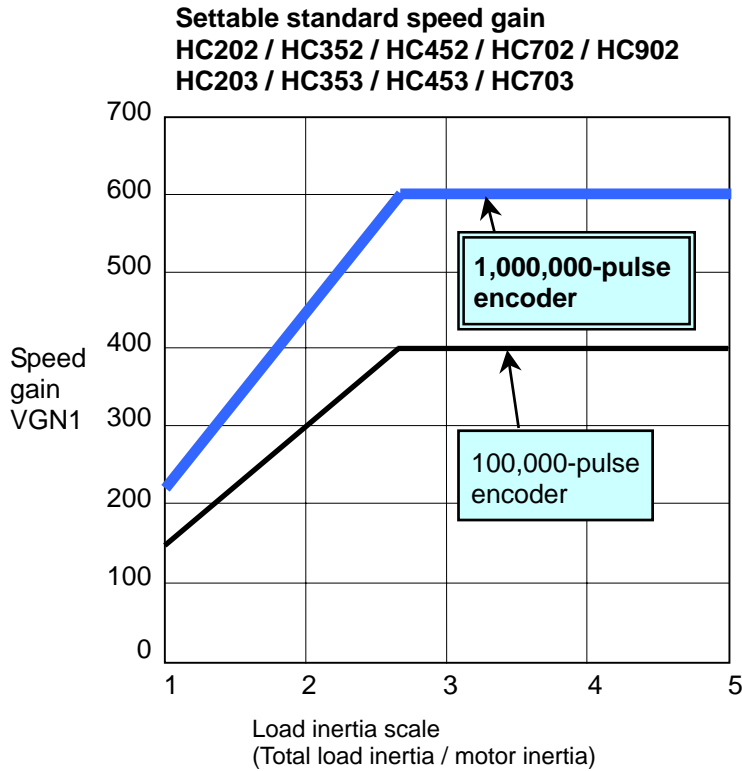

<Standard setting value of speed loop gain (SV005: VGN1) >

■ In case of MDS-CH-V1/V2

Determine the speed loop gain referring to the comparison graph shown below.

In case that the speed loop gain exceeds the standard speed gain value shown in the graph, some machine system easily cause the small vibration as the change of the current command becomes too large for the change of speed feedback by 1 pulse.

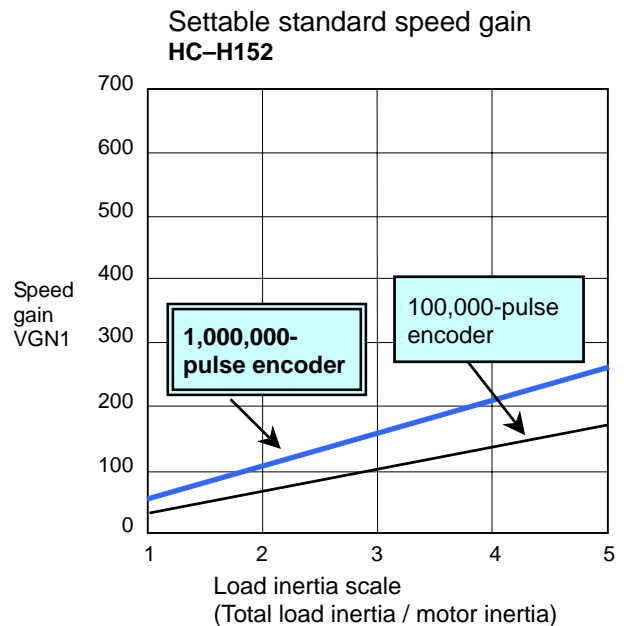
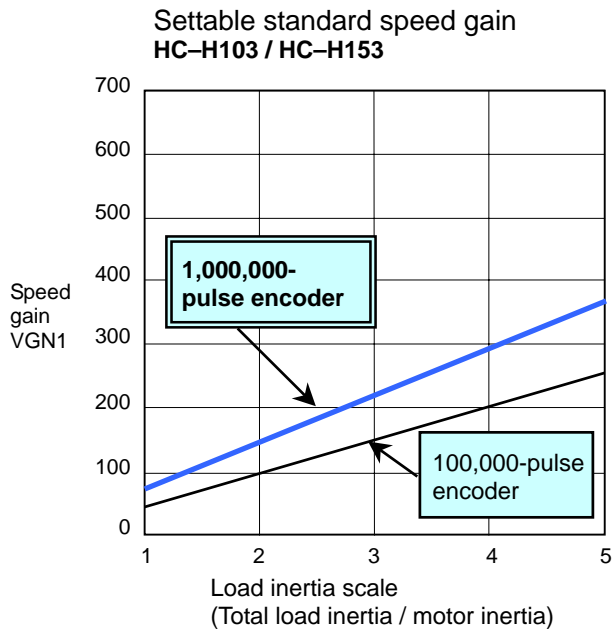
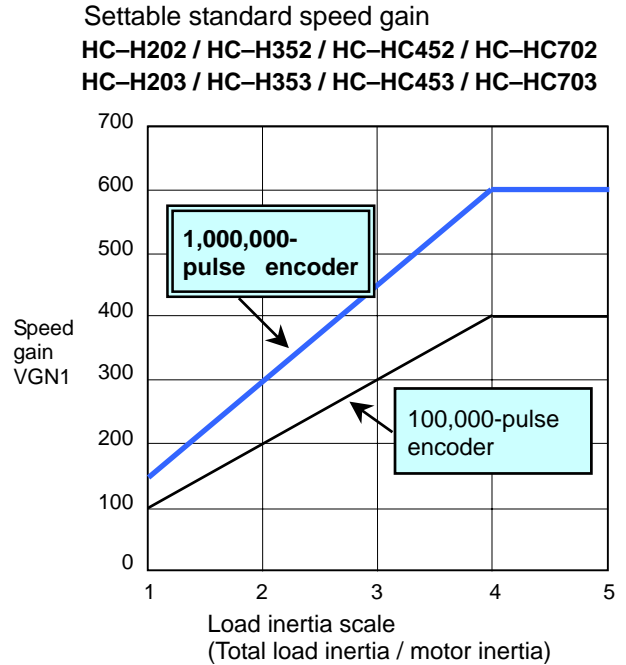
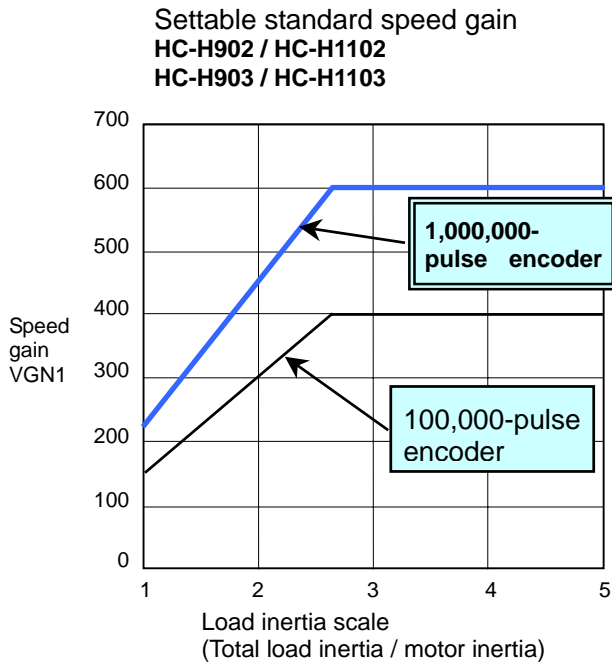

4. Acceleration/deceleration time constant

(1) Adjust rapid traverse feed

To adjust rapid traverse feed, adjust the rapid traverse rate (Rapid) and acceleration/deceleration time constant (G0t) with NC machine parameter. Set the rapid traverse rate corresponding to the machine specifications so that the motor speed becomes less than the specified maximum speed. Set the acceleration/deceleration time constant so that the maximum current command value becomes less than the table below by performing reciprocating operation. With the motor whose speed is specified as "maximum rotation speed > rated speed" (HC, HC-R, HC-MF, HA-FF), output torque is especially limited in the range that exceeds the rated rotation speed. When adjusting, observe the current FB during acceleration/deceleration to set the torque within the specification range. When driver input voltage is too low (170 to 190), be aware that the torque is likely to become insufficient and the excessive error can easily occur during acceleration/deceleration.

(2) Adjust cutting feed

(2-1) In case of machining center:

-When geometry compensation is disabled (G64);

To adjust cutting feed, adjust clamp speed (M3: clamp) and acceleration/deceleration time constant (N2: G1t) with NC machine parameter. In this case, set the same in-position width as when actual cutting is carried out. Determine the clamp speed (maximum cutting speed) and adjust the acceleration/deceleration time constant. (Set the same clamp speed to all the interpolation axes.)

Perform reciprocating cutting feed at the clamp speed (maximum cutting speed) without dwell and adjust the acceleration/deceleration time constant so that the maximum current command value becomes less than the range of the Table3 shown below. The minimum theoretical value of the cutting feed time constant can be calculated by the expression shown below with G0 rapid traverse time constant.

$$N2 = (M3/M1) \times N1 \times 2$$

Define the time constant of the interpolation axis which accelerates at the lowest speed as the common time constant of all axes and set the time constant.

(In interpolation axis, set the same clamp speed and acceleration/deceleration time constant for all axes.)

-When geometry compensation is enabled (G61.1);

To adjust during cutting feed when geometry compensation is enabled, adjust the constant inclination feedrate (L74) and constant inclination acceleration/deceleration time constant (L75).

Set L74/L75 to the inclination value based on the axis whose acceleration (M1/N1) of G0 rapid traverse acceleration/deceleration is the smallest of all interpolation axes allowing cutting load margin. For the cutting load margin, refer to the conventional settings of each machine. Additionally, set the pre-interpolation filter (56.8ms).

[Note] The maximum feedrate during geometry compensation is $M3 \times L76 / 100$.

Table1: Parameter to specify the acceleration/deceleration time constant (Machining center)

Operation pattern		Parameter to set max. speed	Parameter to set time constant	Filter before interpolation	Remarks	
1)	G0 Rapid traverse feed	G0 constant inclination disabled (K96bit7=0 +G64 mode)	M1 (Rapid)	N1 (G0t)	—	
2)	G0 Rapid traverse feed	G0 constant inclination enabled (K96bit7=1)	M1 (Rapid)	N1 (G0t)	K107 (Normally 56.8ms is set)	
3)	G1 cutting feed	Geometry interpolation disabled (G64)	M3 (Clamp)	N2 (G1t)	—	
4)	G1 cutting feed	Geometry interpolation enabled (G61.1)	L74	L75	K107 (Normally 56.8ms is set)	Set feed forward gain separately.

(2-2) In case of NC lathe

-When geometry compensation is disabled (G64);

Cutting feed clamp speed cannot be set in NC lathe. To adjust the cutting feed, adjust the acceleration/deceleration time constant (BS04: G1t) corresponding to the assumed maximum cutting feedrate. As for in-position width in this case, set the same value as in actual cutting.

Determine the maximum cutting feedrate and adjust the acceleration/deceleration time constant. Perform reciprocating cutting feed without dwell at the maximum cutting feedrate and adjust the acceleration/deceleration time constant so that the maximum current command values becomes less than the range of Table3. The minimum theoretical value of the cutting feed time constant can be calculated by the expression shown below with G0 rapid traverse time constant.

$$BS04 = (\text{Maximum cutting feedrate} / A1) \times BS03 \times 2$$

Define the time constant of the interpolation axis which accelerates at the lowest speed as the common time constant of all axes and set that value.

-When geometry compensation is enabled (G61.1) ...Applied to M640MT Ver.D0 and later version of INTEGREX machine.

To adjust during geometry compensation cutting feed, adjust the constant inclination feedrate (B233) and constant inclination acceleration/deceleration time constant (B146).

Set B233/B146 to the inclination value based on the axis whose acceleration of G0 rapid traverse feed is the smallest of all interpolation axes allowing cutting load margin. However, set $A1/(BS03 \times 1.2)$ in X-axis and Y-axis though the rest of G0 rapid traverse feed acceleration/deceleration is set to $A1/BS03$ (*Note 1). Refer to the conventional settings of each machine when setting cutting load margin. Additionally, set the filter pre-interpolation (56.8ms).

[Note] The maximum feedrate during geometry compensation is B147.

(*Note)The reason why the constant inclination acceleration/deceleration of INTEGREX machine is increased by 1/1.2 times

Carefully adjust the parameter of INTEGREX machine following the precautions below as it has compound axis (inclined Y-axis).

Normally, when adjusting Y-axis (compound axis), the adjusted parameter of Yt-axis (actual axis) is set as Y-axis parameter.

In this case, the acceleration (inclination) of pre-interpolation acceleration/deceleration in geometry compensation occasionally exceeds the setting value of the parameter (=B233/B146)

In short, when moving in Y-axis direction within the tolerance acceleration time as shown in Fig.A, the movement component distributed to the actual axes (X-axis and Y-axis) shows that acceleration is increased by $1/\sin\theta$ times in Yt-direction. In Fig.B, when moving to vertical direction against Yt-axis within the tolerance acceleration, the acceleration increased by $1/\sin\theta$ times occurs toward X-axis direction.

In INTEGREX machine, $\theta = 60^\circ$. Therefore, $1/\sin\theta = 1/\sin 60^\circ \approx 1.2$.

To prevent the movement acceleration distributed to actual axes from exceeding the tolerance acceleration, thus, set the parameter on the basis of the acceleration ($A1/(BS3 \times 1.2)$) increased by 1/1.2 times to the G0 rapid traverse acceleration ($A1/BS3$) adjusted in Yt-axis in advance.

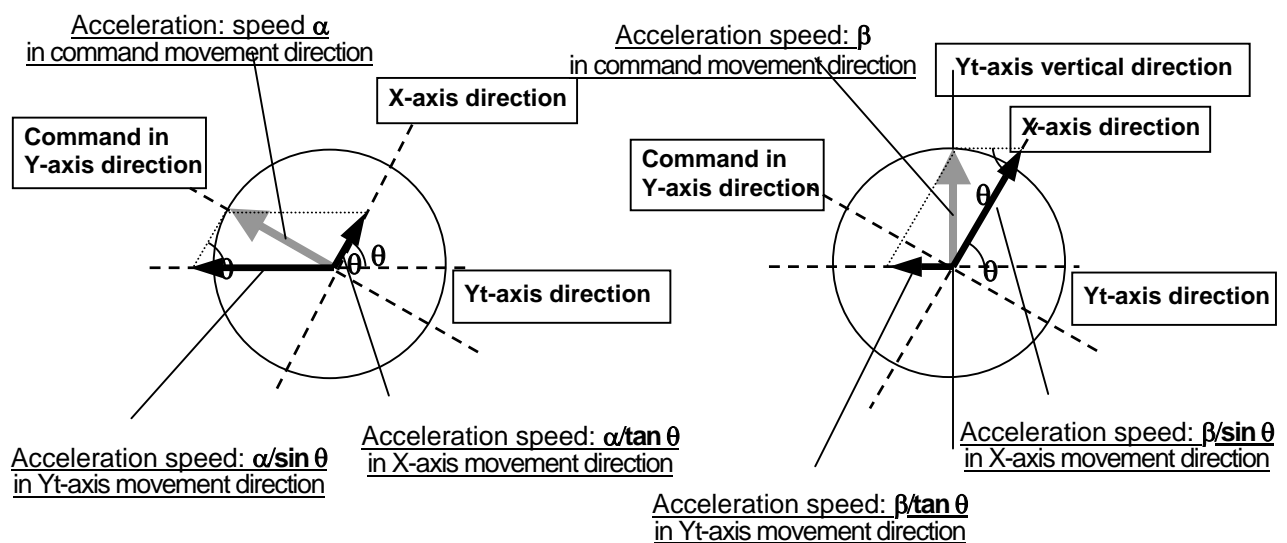

Fig.A: In case of max. acceleration in Yt-axis

Fig.B: In case of max. acceleration in X-axis

Table2: Parameter to determine acceleration/deceleration time constant (NC lathe)

Operation pattern			Parameter to set max. speed	Parameter to set time constant	Filter before interpolation	Remarks
1)	G0 Rapid traverse feed	G0 constant inclination disabled. (G64)	A1(Rapid)	BS3 (G0t)	–	
2)	G0 Rapid traverse feed	G0 constant inclination enabled (Interpolation type + G61.1)	A1(Rapid)	BS3 (G0t)	B112 (Normally 56.8ms is set)	
3)	G1 cutting feed	Geometry compensation disabled (G64)	A4(Clamp)	BS4 (G1t)	–	
4)	G1 cutting feed	Geometry compensation enabled (G61.1)	B233 (G1bF)	B146 (G1btL)	B112 (Normally 56.8ms is set)	Set feed forward gain separately.

2) and 4) are available only when geometry compensation are optioned to the INTEGREX machine Ver. D0 or later versions.

(3) Maximum current value by each motor during acceleration/deceleration time constant adjustment

■ In case of MDS-C1-V1/V2

The maximum current values by each motor during acceleration/deceleration time constant adjustment are shown in the right column of the table below.

Table3.1: Maximum current value by each motor

Motor type	Stall rating current	Specified max. current		Current limit value	Standard value for adjustment	Motor type	Stall rating current	Specified max. current		Current limit value	Standard value for adjustment
	%	A	%	%	%		%	A	%	%	%
HC52	3.94	17	431	431	Within 388%	HC53	5.8	17	293	293	Within 264%
HC102	7.4	28	378	383	Within 340%	HC103	9.8	28	286	289	Within 257%
HC152	11.1	47	423	431	Within 380%	HC153	15.9	47	296	300	Within 266%
HC202	15.4	47	305	311	Within 275%	HC203	22.4	64	286	285	Within 257%
HC352	22.9	64	279	279	Within 251%	HC353	33.3	85	255	287	Within 230%
HC452	40.4	85	210	242	Within 189%	HC453	57.3	113	197	228	Within 177%
HC702	46.2	113	245	245	Within 221%	HC703	67.2	141	210	210	Within 189%
HC902	55.9	141	252	252	Within 227%						
HA-LF15K	100	260	260	260	Within 234%						

■ In case of MDS-CH-V1/V2

The maximum current values by each motor during acceleration/deceleration time constant adjustment are shown in the right column of the table below.

Table3.2: Maximum current value by each motor

Motor type	Stall rating current	Specified max. current		Current limit value	Standard value for adjustment	Motor type	Stall rating current	Specified max. current		Current limit value	Standard value for adjustment
	%	A	%	%	%		%	A	%	%	%
						HC-H103	4.6	14.1	307	307	276%
HC-H152	4.3	23.8	553	554	Within 498%	HC-H153	6.1	23.8	390	390	351%
HC-H202	6.3	23.8	378	378	Within 340%	HC-H203	9.0	31.8	353	353	318%
HC-H352	10.9	31.8	292	292	Within 263%	HC-H353	17.7	47.7	269	269	243%
HC-H452	15.8	47.7	302	302	Within 272%	HC-H453	23.6	63.6	269	269	243%
HC-H702	20.2	63.6	315	315	Within 283%	HC-H703	33.0	71.0	215	215	194%
HC-H902	29.4	71.0	241	241	Within 217%	HC-H903	41.8	101.8	243	243	219%
HC-H1102	55.8	124.0	222	233	Within 200%	HC-H1103	59.6	124.0	208	218	187%

5. Position loop gain

(1) Operation patterns to confirm position loop gain

The limit of the position loop gain is confirmed by the following operation patterns.

-The operation patterns to be performed by machining center

Operation pattern			Details
1)	G0 Rapid traverse feed	G0 constant inclination disabled. (K96bit7=0, +G64 mode)	Perform reciprocating rapid traverse feed at the maximum rapid traverse rate with dwell, measure speed–position droop. If the overshooting amount during a stop is less than 1μm, there will be no problem. Confirm also that no vibration occurs.
2)	G0 Rapid traverse feed	G0 constant inclination enabled (K96bit7=1)	Perform reciprocating rapid traverse feed at the maximum rapid traverse rate with dwell, measure speed–position droop. If the overshooting amount during a stop is less than 1μm, there will be no problem. Confirm also that no vibration occurs.
3)	G1 cutting feed	Geometry compensation disabled (G64)	Perform reciprocating cutting feed at the maximum cutting feedrate without dwell, measure speed–position droop. If the droop fluctuation width during constant speed feed is less than 3μm, there will be no problem. If the operation without dwell is not performed in the machine (or in axes), judge with dwell.
4)	G1 cutting feed	Geometry compensation enabled (G61.1)	Perform reciprocating cutting feed at the maximum cutting feedrate with dwell, and measure the speed–position droop. If the overshooting amount during a stop is less than 1μm, there will be no problem. Confirm also that no vibration occurs.
5)	Manual feed		Perform reciprocating rapid traverse feed at the maximum manual feedrate with dwell, measure the speed–position droop. If the overshooting amount during a stop is less than 1μm, there will be no problem. Confirm also that no vibration occurs. (Confirm the waveform only, as this is the same as the case that G0 constant inclination is disabled.)
6)	Handle feed		Carry out the pulse input with the maximum scale and confirm that no vibration occurs.

For 1) to 4), submit the current– speed –position droop waveform at which the position loop gain reaches to the limit.

-The operation patterns to be performed by NC lathe (In case without geometry compensation)

Operation pattern		Details
1)	G0 Rapid traverse feed	Perform reciprocating rapid traverse feed at the maximum rapid traverse rate with dwell, measure speed–position droop. If the overshooting amount during a stop is less than 1 μm, there will be no problem. Confirm also that no vibration occurs.
2)	G1 Cutting feed	Perform reciprocating cutting feed at the maximum cutting feedrate without dwell, measure speed–position droop. If the droop fluctuation range during constant speed feed is less than 3 μm, there will be no problem. Confirm also that no vibration occurs.
3)	Manual feed	Perform reciprocating rapid traverse feed at the maximum manual feedrate with dwell, measure speed–position droop. If the overshooting amount during a stop is less than 1 μm, there will be no problem. Confirm also that no vibration occurs. (Confirm the waveform only, as this is the same as the case that G0 constant inclination is disabled.)
4)	Handle feed	Carry out the pulse input with the maximum scale and confirm also that no vibration occurs.

For 1) to2), submit the current– speed –position droop waveform at which the position loop gain reaches to the limit.

The operation patterns to be performed by NC lathe (In case with geometry compensation: Geometry compensation is available only when geometry compensation are optioned to the INTEGREGX machine Ver.D0 or later version.)

Operation pattern		Details
1)	G0 Rapid traverse feed G0 constant Inclination disabled. (G64)	Perform reciprocating rapid traverse feed at the maximum rapid traverse rate with dwell, measure speed–position droop. If the overshooting amount during a stop is less than 1 μm, there will be no problem. Confirm also that no vibration occurs.
2)	G0 Rapid traverse feed G0 constant inclination enabled (Interpolation type +G61.1)	Perform reciprocating rapid traverse feed at the maximum rapid traverse rate with dwell, measure speed–position droop. If the overshooting amount during a stop is less than 1 μm, there will be no problem. Confirm also that no vibration occurs.
3)	G1 cutting feed Geometry compensation disabled (G64)	Perform reciprocating cutting feed at the maximum cutting feedrate without dwell, measure speed–position droop. If the droop fluctuation range during constant speed feed is less than 3 μm, there will be no problem. Confirm also that no vibration occurs. If the operation without dwell is not performed in the machine (or in axes), judge with dwell.
4)	G1 cutting feed Geometry compensation enabled (G61.1)	Perform reciprocating cutting feed at the maximum cutting feedrate with dwell, measure speed–position droop. If the overshooting amount during a stop is less than 1 μm, there will be no problem. Confirm also that no vibration occurs.
5)	Manual feed	Perform reciprocating rapid traverse feed at the maximum manual feedrate with dwell, measure speed–position droop. If the overshooting amount during a stop is less than 1 μm, there will be no problem. Confirm also that no vibration occurs. (Confirm the waveform only, as this is the same as the case that G0 constant inclination is disabled.)
6)	Handle feed	Carry out the pulse input with the maximum scale and confirm also that no vibration occurs.

For 1) to4), obtain current– speed –position droop waveform at which the position loop gain reaches to the limit.

(2) Criterion of position loop gain limit

Generally, according as the speed loop gain becomes higher, overshooting occurs during a stop. In case that the axis which nearly reaches the position loop gain limit exists, position loop gain is limited as the same position loop gain value have to be set to all the interpolation axes.

Position loop gain limit has to be judged according to the following criterion after measuring overshooting amount during a stop.

When machine vibration is remarkable, measure also the position droop fluctuation width during constant speed feed for judging the position loop gain limit.

(However, position droop fluctuation width cannot be used as the criterion of closed machine that uses a scale because the position droop fluctuation width will become larger if the position resolution is low. In this case, only the overshooting amount during a stop can be the criterion.)

Criterion of position loop gain limit

Operation pattern	Overshooting during a stop (Criterion of position loop gain limit)	Position droop fluctuation range (Ref. Criterion of)
G0 Rapid traverse feed	Within 1 μm	Within 4 μm
G1 Cutting feed	Within 1 μm	Within 3 μm
Manual feed	Within 1 μm	Within 4 μm
Handle feed	Carry out the pulse input with the maximum scale and confirm that there is no vibration.	

(3) SHG control

In SHG control mode, set PGN1, PGN2 and SHGC by the following ratio.

$$\text{PGN1} : \text{PGN2} : \text{SHGC} = 1 : \frac{8}{3} : 6$$

During SHG control, speed loop gain response has to be high enough as the actual position loop gain becomes high even though PGN1 is set to the same value. If the speed loop responsiveness is low, vibration and overshooting will occur. Lower the position loop gain when speed loop gain is lowered due to the machine resonance occurrence.

No.	Abbrev.	Parameter name	Ratio	Examples										Explanation	Setting range
SV003 (SV049)	PGN1 (PGN1sp)	Position loop gain1	1	23	26	33	38	47	60	70	80	90	100	Specify with a set of 3 parameters.	1 to 200
SV004 (SV050)	PGN2 (PGN2sp)	Position loop gain2	$\frac{8}{3}$	62	70	86	102	125	160	186	213	240	266		0 to 999
SV057 (SV058)	SHGC (SHGCsp)	SHG control gain	6	140	160	187	225	281	360	420	480	540	600		0 to 1200
S4	Fwd_g	Ideal feed forward gain		51	53	51	54	54	55	56	58	59	60		0 to 100
SV008	VIA	Speed loop leading ..		Set to "1900" as a standard during SHG control.											1 to 9999
SV015	FFC	Acceleration feed forward gain		Set to "1900" as a standard during SHG control.											0 to 999

<How to set when position loop gain is not improved>

With MDS-C1-V1/V2 (High gain mode), high-position loop gain can be expected because speed loop gain and current loop gain is improved. However, position loop gain will not be raised enough in case that the machine rigidity is low. In this case try the following operations.

(1) In case that the machine center of the gravity is too high and the vibration occurs at 10 to 20Hz during a stop;

If the machine center of the gravity is too high for the drive unit of the ball screw as shown below, position loop gain cannot be raised, as the stable speed loop band cannot be secured due to the fall of machine response speed. In this case, the position loop can be raised by raising the response speed at 10 to 20Hz using disturbance observer function.

Machine action in case of heavy center of gravity

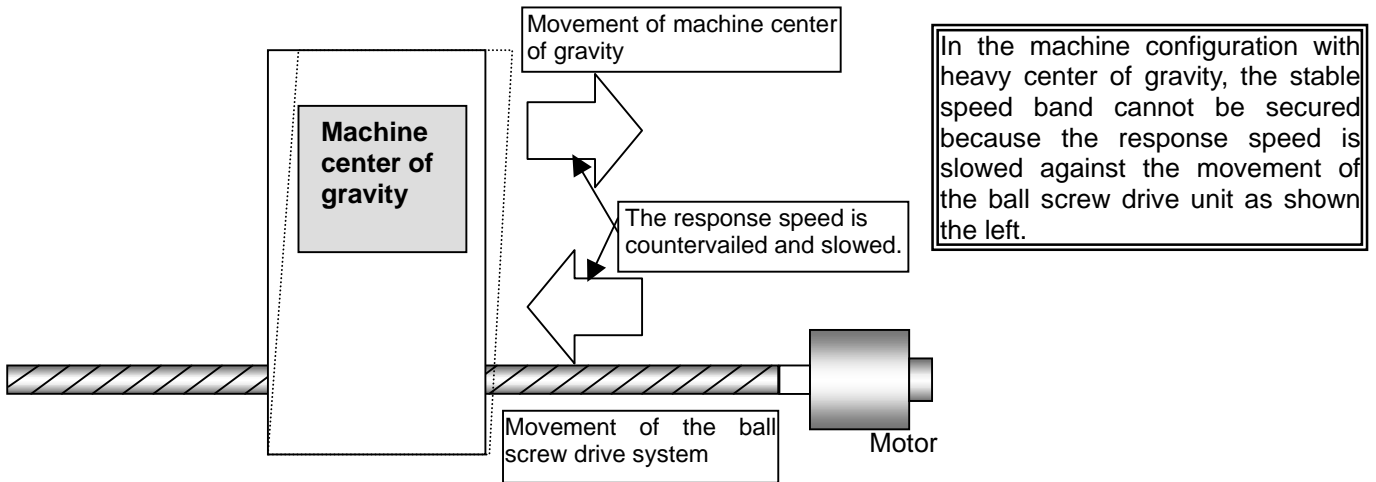

Effect by the disturbance observer against the machine vibration between 10 and 20Hz in case of heavy machine center of gravity

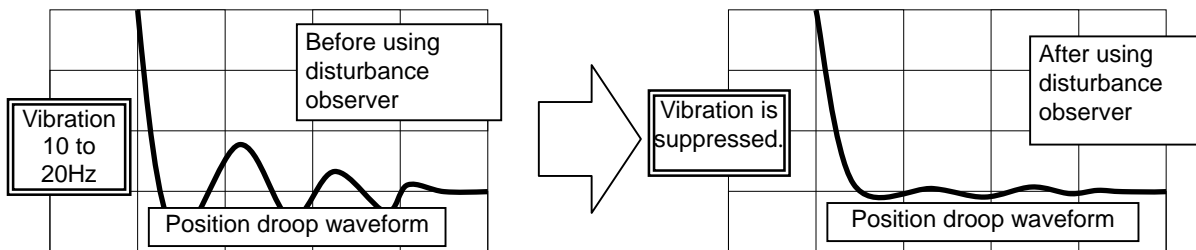

<How to set the disturbance observer to suppress the vibration>

1. Lower the VGN1 by 20 to 30% from the value adjusted where vibration is eliminated.
2. Set the load inertia scale (SV037:JL) to the inertia "200 to 300" and set disturbance observer2 (SV044:OBS2) to "100".
3. Set disturbance observer 1 (SV043:OBS1) and set 200 to 300 to the observer filter band (observer pole).
4. Set 70% of speed loop gain limit after checking the speed loop gain limit again.

Parameter concerning with disturbance observer function.

No.	Abbrev	Parameter name	Unit	Explanation	Setting range
SV037	JL	Load inertia scale	%	Set the load inertia that includes the motor in respect to the motor inertia. (When the motor is a single unit, set 100%)	0 to 5000 (%)
SV043	OBS1	Disturbance observer 1	rad/sec	Set the observer filter band (observer pole) Set about 200 to 300.	0 to 1000 (rad)
SV044	OBS2	Disturbance observer 2	%	Set the observer gain. Set about 100 and lower the setting if vibration occurs.	0 to 500 (%)

[Note 1] Make sure to measure the speed loop gain limit again.

By using disturbance observer function, the speed loop gain is equivalently raised. In case that the margin is not allowed, therefore, it is very dangerous as the vibration can occur.

[Note 2] What can do with disturbance observer is to suppress the machine vibration between 10 to 20Hz. Comparing with the case that disturbance observer is not used, position loop gain can be raised by 20 to 30%, however, machine configuration has to be reconsidered and position command has to be considered to eliminate the vibration between 10 and 20Hz.

(2) In case that the vibration between 10Hz and 20Hz occurs during a stop in the closed system using scale etc.

In closed system such as that of large machine, if the connection point of the motor and machine or rigidity of the machine system is weak, position loop gain cannot be raised as the response during acceleration and deceleration becomes vibratory and overshooting is caused. In this case, dual feedback function is more effective.

When dual feedback function is enabled, the position feedback by the detector at the motor end is used for stable control in high acceleration range. In low acceleration range, position feedback by the detector (or a scale) at the machine end is used for improving the precision. As a result, the position loop gain is raised.

Dual feedback block

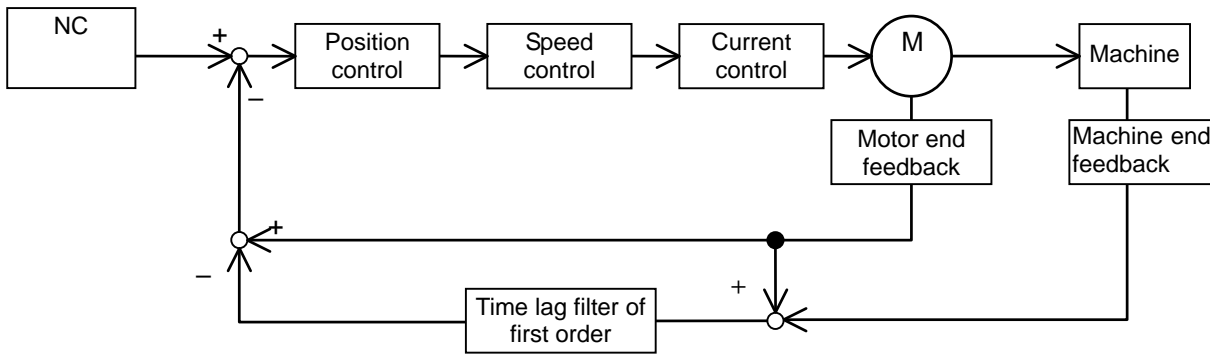

Effect by dual feedback control

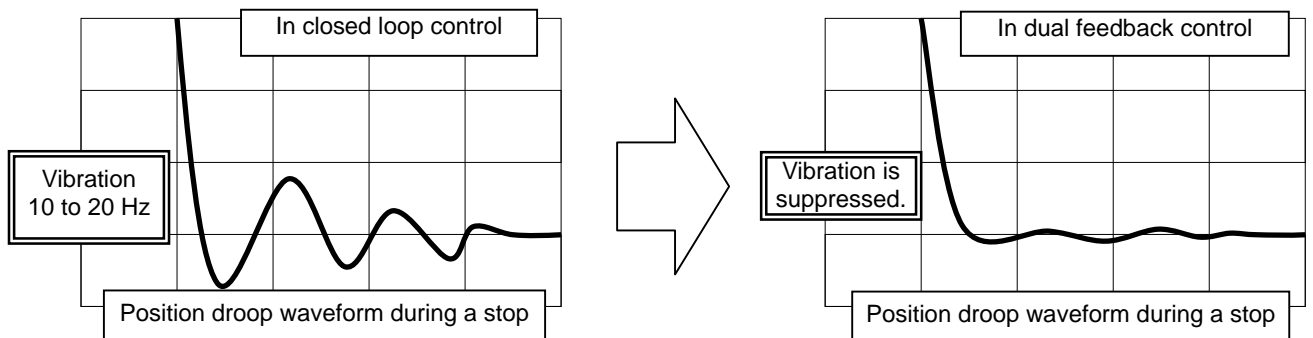

Setting dual feedback time constant

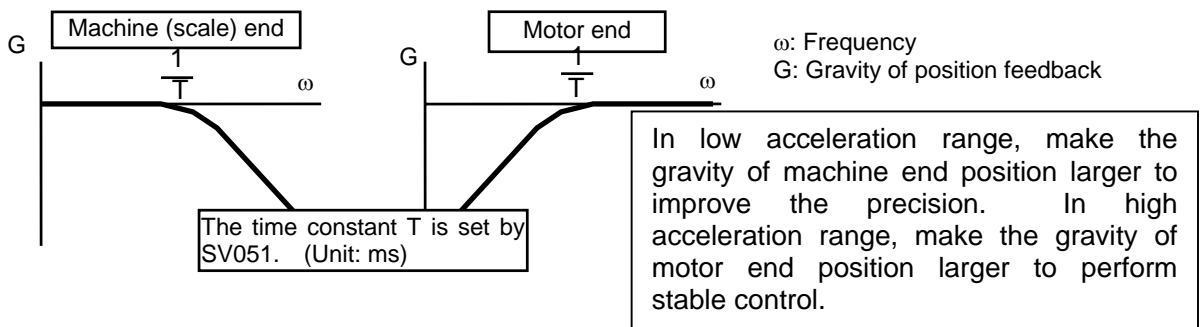

<How to perform dual feedback control (in closed control)>

1. Set SPEC(SV017)bit to "1", and enable dual feedback function. (Need to turn OFF and ON the power.)
2. Set the first-order lag time constant in DFBT(SV051). ("100" as a standard)
3. Measure the overshooting of position droop raising DFBT(SV051) by 10ms.
Set the time constant at which the overshooting is eliminated.
4. According as time constant becomes larger, the system becomes closer to the semi-closed system. As a result, position loop gain is raised.

[Note 1] The position loop gain limit raised by the dual feedback function is equivalent to the position loop gain limit in the semi-closed system which does not use a detector (or a scale) at the machine end.

The position loop gain limit does not become higher than that in semi-closed system.

[Note 2] Even though "0" is set in DFBT(SV051) when dual feedback function is enabled, 1ms (the minimum value) is used internally.

The parameter concerning with dual feedback function

Name	Abbrev.	Details	Setting range (unit)																																								
SV017	SPEC	Servo specifications <table border="1" style="width: 100%; text-align: center;"> <tr> <td>F</td><td>E</td><td>D</td><td>C</td><td>B</td><td>A</td><td>9</td><td>8</td><td>7</td><td>6</td><td>5</td><td>4</td><td>3</td><td>2</td><td>1</td><td>0</td> </tr> <tr> <td colspan="4">spm</td> <td>drvall</td> <td>drvup</td> <td>mpt3</td> <td>mp</td> <td>abs</td> <td>vmh</td> <td>vdir</td> <td>fdir</td> <td></td> <td>seqh</td> <td>dfbx</td> <td>vdir2</td> </tr> </table> <table border="1" style="width: 100%; text-align: center;"> <tr> <td>Bit</td> <td>Name</td> <td>Meaning when "0" is set.</td> <td>Meaning when "1" is set.</td> </tr> <tr> <td>1</td> <td>dfbx</td> <td>Dual feedback control is disabled.</td> <td>Dual feedback control is enabled.</td> </tr> </table>	F	E	D	C	B	A	9	8	7	6	5	4	3	2	1	0	spm				drvall	drvup	mpt3	mp	abs	vmh	vdir	fdir		seqh	dfbx	vdir2	Bit	Name	Meaning when "0" is set.	Meaning when "1" is set.	1	dfbx	Dual feedback control is disabled.	Dual feedback control is enabled.	
F	E	D	C	B	A	9	8	7	6	5	4	3	2	1	0																												
spm				drvall	drvup	mpt3	mp	abs	vmh	vdir	fdir		seqh	dfbx	vdir2																												
Bit	Name	Meaning when "0" is set.	Meaning when "1" is set.																																								
1	dfbx	Dual feedback control is disabled.	Dual feedback control is enabled.																																								
SV051	DFBT	Set the time constant during dual feedback control.	0 to 9999 (msec)																																								
SV052	DFBN	Set the voltage dead zone during dual feed back control.	0 to 9999 (μm)																																								

6. Vertical axis setting



CAUTION To use vertical axis drop prevention control function, the power supply control axis has to be set depending on the system configuration. Refer to the specification manual for further details.

(1) Vertical axis drop prevention control function (deceleration stop function)

Vertical axis drop prevention control is a function that prevents the vertical axis from dropping due a delay in the brake action when an emergency stop is inputted. No-operation-time is eliminated by delaying READY OFF of servo driver as much as the time set with a parameter that is since the emergency stop was inputted.

<Overview and parameter settings>

This function is controlled depending on the servo status as follows;

During a stop --- Driver is turned to "READY OFF" when vertical axis drop prevention time (SV048) has passed.

During movement --- Deceleration stop is performed. Driver is turned to "READY OFF" when either of longer time, vertical axis drop prevention time (SV048) or maximum delay time for emergency stop (SV55), has passed.

No.	Abbrev.	Name	Details	Setting range
SV048	EMGr	Vertical axis stop prevention time (ms)	Input the time to delay the READY OFF when an emergency stop occurs. Set the value which is larger than the time when the brake is working. When the input power supply is OFF, the vertical axis drop prevention time set here is not guaranteed.	0 to 2000 (msec)
SV055	EMGx	Maximum delay time for emergency stop (ms)	Set the maximum READY OFF delay time. Normally set the same value as SV048. When executing READY OFF after deceleration stop, set the same value as SV056. This is enabled only when SV056 is larger than SV048. When setting the value which is smaller than SV048 in the parameter, the same value as SV048 is automatically set. When input power supply is OFF, the maximum delay time for emergency stop is not guaranteed.	0 to 2000 (msec)
SV056	EMGt	Deceleration control time constant during emergency stop.	When SV048 is set, deceleration stop is performed and deceleration stop time constant also has to be set. Set the same value as rapid traverse time constant. When this parameter is set, constant linear deceleration stop is performed during emergency stop. When "0" is set, step stop is performed.	0 to 2000 (msec)

[Note 1] If setting both SV048 and SV055 to "0", drop prevention function will be disabled.

[Note 2] SV048 and SV055 is set by each axis, however, when the different values are set to each axis in the same driver, the larger value is enabled.

[Note 3] If only SV048 is set, deceleration stop will be changed to step stop and machine vibration will occur. Therefore, make sure to set the rapid traverse acceleration/deceleration time constant in SV055.

(2) Torque offset function

If the load torque differs in the positive and negative directions such as with a vertical axis or slant axis, the torque offset (SV032: TOF) is set to carry out accurate lost motion compensation.

<Setting method>

Measure the unbalance torque. Carry out reciprocation operation (approx. F1000) with the axis to be compensated and measure the load current % when fed at a constant speed on the CNC servo monitor screen. The unbalance torque at this time is expressed with the following expression.

$$\text{Unbalance torque} = \frac{(+\text{feed load current}\%) + (-\text{feed load current}\%)}{2}$$

For the torque offset (TOF), set above unbalance torque value.

If direction makes any difference in the protrusion amount, adjust with LMC2. Never adjust with TOF.

No.	Abbrev.	Parameter name	Unit	Explanation	Setting value
SV032	TOF	Torque offset	Stall% (rated current%)	Set when performing lost motion compensation. Set the unbalance torque amount.	- 100 to 100

[Note] Even if TOF is set, the torque output characteristics of the motor and load current display of the CNC servo monitor will not change. Only LMC compensation characteristics is affected.

7. Lost motion compensation (LMC compensation)

The lost motion compensation compensates the response delay during the reversal by adding the torque command set with the parameters when the speed direction changes. There are three methods for lost motion compensation. With the machining center, type 3 is used as a standard. With the NC lathe, type 2 is used as a standard.

(For further details of type 3, refer to “LOST MOTION COMPENSATION TYPE 3 FUNCTION SPECIFICATIONS MANUAL” <BNP-A2993-74>.)

<Setting method>

1. Set the special servo function selection1 (SV027:SSF)bit9. (The LMC compensation type 2 will start.)
2. Set the compensation amount with a stall (% unit) in the lost motion compensation 1 (SV016: LMC1) (For the general-purpose motor, rated current “%” is used as a unit). The LMC1 setting value will be used for compensation in positive and negative directions when SV041: LMC2 is “0”.
3. If the compensation amount is to be changed in the direction to be compensated, set LMC2. The compensation direction setting will be as shown below with the CW/CCW setting in the CNC parameter. If only one direction is to be compensated, set the side not to be compensated as -1.

If the delay occurs in the quadrant protrusion in the circle or arc cutting as shown below in respect to the cutting direction when CNC sampling measurement (DDB measurement) or actual cutting is carried out, and the compensation appears before the protrusion position, set the lost motion compensation timing (SV039: LMCD).

While measuring the arc path, increase LMCD by 10 msec at a time, to find the timing that the protrusion and compensation position match.

Compensation Point	CW	CCW
A	X axis: LMC2	X axis: LMC1
B	Y axis: LMC1	Y axis: LMC2
C	X axis: LMC1	X axis: LMC2
D	Y axis: LMC2	Y axis: LMC1

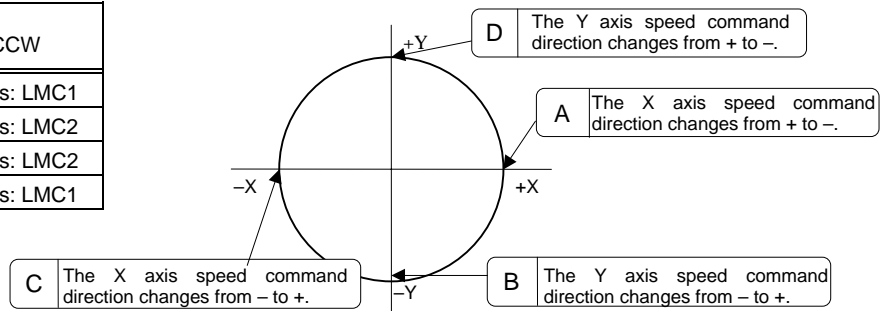

No.	Abbrev.	Parameter name	Explanation																																												
SV027	SSF1	Special servo function selection 1	<p>The lost motion compensation starts with the following parameters.</p> <table border="1" style="width: 100%; text-align: center;"> <tr> <td>15</td><td>14</td><td>13</td><td>12</td><td>11</td><td>10</td><td>9</td><td>8</td><td>7</td><td>6</td><td>5</td><td>4</td><td>3</td><td>2</td><td>1</td><td>0</td> </tr> <tr> <td>afct</td><td>zm2</td><td>afrg</td><td>afse</td><td>ovs2</td><td>ovs1</td><td>lmc2</td><td>lmc1</td><td>omr</td><td></td><td>vfct2</td><td>vfct1</td><td></td><td>upc</td><td>vcnt2</td><td>vcnt1</td> </tr> </table> <table border="1" style="width: 100%; text-align: center;"> <thead> <tr> <th>bit</th> <th>No LMC</th> <th>LMC type2</th> <th>Setting prohibited</th> </tr> </thead> <tbody> <tr> <td>8 lmc1</td> <td>0</td> <td>0</td> <td>1</td> </tr> <tr> <td>9 lmc2</td> <td>0</td> <td>1</td> <td>1</td> </tr> </tbody> </table>	15	14	13	12	11	10	9	8	7	6	5	4	3	2	1	0	afct	zm2	afrg	afse	ovs2	ovs1	lmc2	lmc1	omr		vfct2	vfct1		upc	vcnt2	vcnt1	bit	No LMC	LMC type2	Setting prohibited	8 lmc1	0	0	1	9 lmc2	0	1	1
15	14	13	12	11	10	9	8	7	6	5	4	3	2	1	0																																
afct	zm2	afrg	afse	ovs2	ovs1	lmc2	lmc1	omr		vfct2	vfct1		upc	vcnt2	vcnt1																																
bit	No LMC	LMC type2	Setting prohibited																																												
8 lmc1	0	0	1																																												
9 lmc2	0	1	1																																												

No.	Abbrev.	Parameter name	Unit	Explanation	Setting range
SV016	LMC1	Lost motion compensation 1	Stall% (rated current%)	While measuring the quadrant protrusion amount, adjust with a 5% unit. The ±direction setting value will be applied when LMC 2 is set to “0”.	-1 to 200 (%)
SV041	LMC2	Lost motion compensation 2	Stall% (rated current%)	Set “0” as a standard. Set this when the compensation amount is to be changed according to the direction.	-1 to 200 (%)
SV039	LMCD	Lost motion compensation timing	Msec	Set this when the lost motion compensation timing does not match. Adjust while increasing value by 10 at a time.	0 to 2000 (msec)

<Adjustment method>

First, confirm whether the axis to be compensated is an unbalance axis (vertical axis, slant axis). If it is an unbalance axis, carry out the adjustment after performing step "(2) unbalance torque compensation". Next, measure the frictional torque. Carry out reciprocation operation (approx. F1000) with the axis to be compensated and measured the load current % when fed at a constant speed on the CNC servo motion screen. The frictional torque of the machine at this time is expressed with the following expression.

$$\text{Frictional torque} = \left| \frac{(+ \text{ feed load current\%}) - (-\text{feed load current})}{2} \right|$$

The standard setting value for the lost motion compensation 1 (LMC1) is double the frictional torque above.

(Example)

Assume that the load current % was 25% in the + direction and -15% in the - direction when JOG feed was carried out at approx. F1000. The frictional torque is as shown below, so $20\% \times 2 = 40\%$ (LMC2 remains at zero, and compensation is carried out in both directions.) is set for LMC1. (LMC2 is left set at "0".) With this setting, 40% compensation will be carried out when the command reverses from the + direction to the - direction, and when the command reverses from the - direction to the + direction.

$$\left| \frac{25 - (-15)}{2} \right| = 20\%$$

For the final adjustment, measure the CNC sampling measurement (DBB measurement) or while carrying out actual cutting. If the compensation amount is insufficient, increase LMC1 or LMC2 by 5% at a time. Note that if the setting is too high, biting may occur.

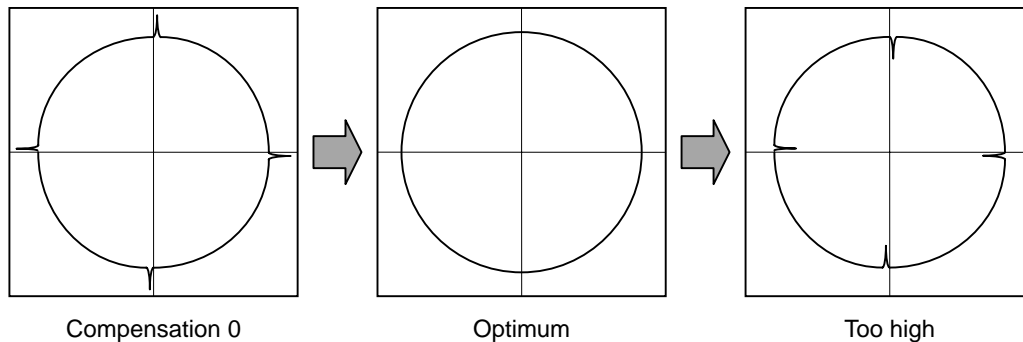

[Note1] When either parameter SV016: LMC1 or SV041 LMC2 is set to "0", the same amount of compensation is carried out in both the positive and negative direction with the setting value of the other parameter (the parameter not set to "0").

[Note2] To compensate in only one direction, set "-1" in the parameter (LMC1 or LMC2) for the direction in which compensation is prohibited.

[Note3] The value set based on the friction torque is the standard value for LMC compensation. The optimum compensation amount changes with the cutting conditions (cutting speed, cutting radius, blade type, workpiece material etc.) Make test cuts matching the target cutting and determine the compensation amount ultimately.

8. Machine end compensation (Machining center)

This is a new function added to MDS-C1-V1/V2 (High gain mode). This function enables to compensate the machine end geometry during high-speed acceleration/deceleration.

(1) Overview

Machine end compensation enables to compensate the spring action between machine (spindle) end and motor (scale) end.

In the machine with a large spring action, the geometry (complete round) can be worsened as the machine (spindle) end occasionally swells to the outside of the motor (scale end) during high-speed feed (especially in smaller radius) though the geometry during low-speed feed is shaped well. By using machine end compensation function, motor (scale) movement is controlled by speed and the effect can be confirmed obviously with the roundness when adjusting servo.

However, adjustment by the roundness is basically required.

[Note] This function is applied to the software version A2B and later version. (as of 1/OCT/1999)

Example of geometry error occurrence (during round drive) and effect of machine end compensation

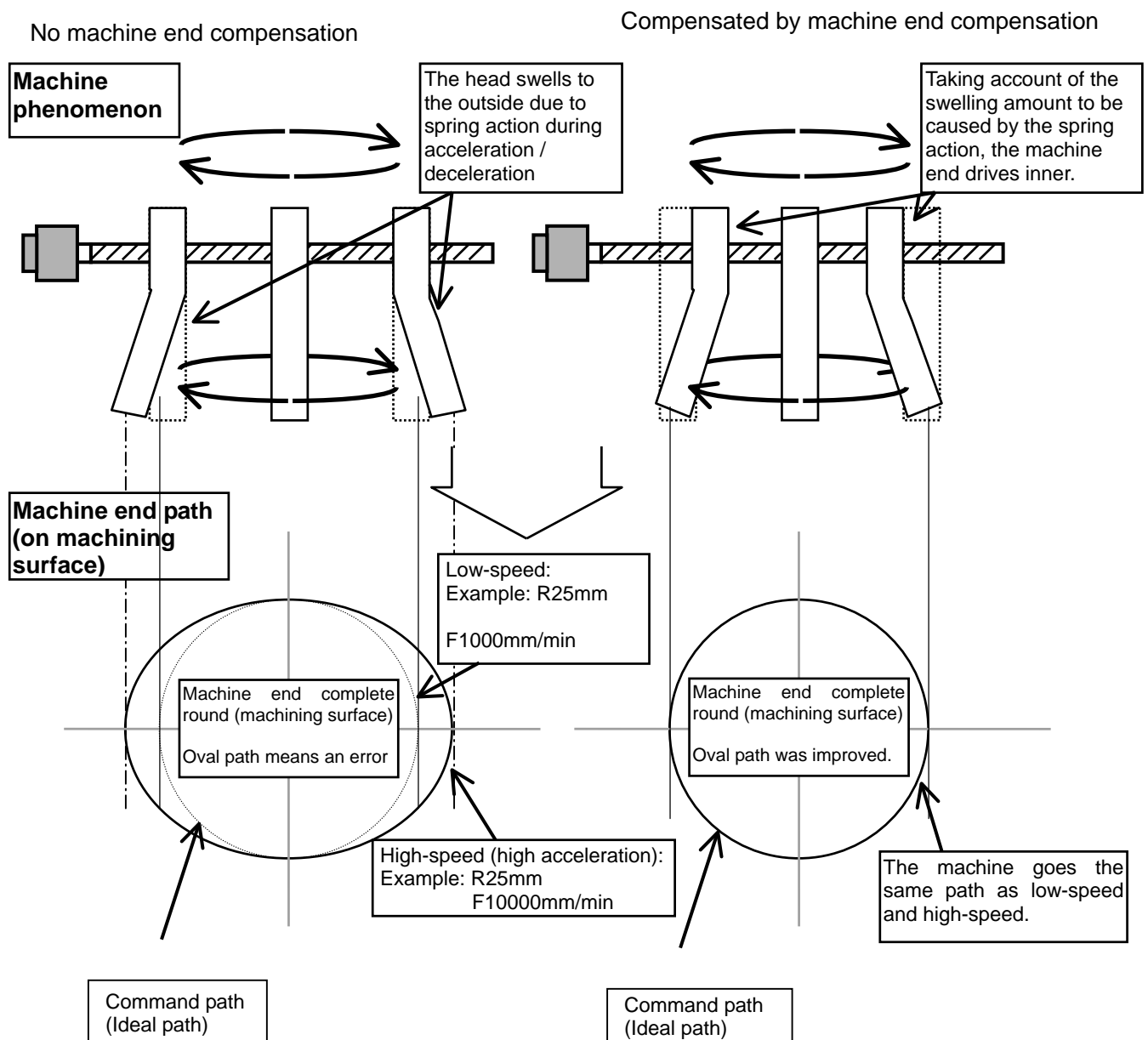

(2) Setting method

How to set the machine end compensation function with MDS-C1-V1/V2 (High gain mode)

No.	Abbrev	Parameter name	Explanation																																								
SV027	SSF1	Special servo function selection 1	<p>The machine end compensation starts with the following parameters.</p> <table border="1" style="width: 100%; text-align: center;"> <tr> <td>15</td><td>14</td><td>13</td><td>12</td><td>11</td><td>10</td><td>9</td><td>8</td><td>7</td><td>6</td><td>5</td><td>4</td><td>3</td><td>2</td><td>1</td><td>0</td> </tr> <tr> <td>afll</td><td>zm2</td><td>afrg</td><td>afse</td><td>ovs2</td><td>ovs1</td><td>lmc2</td><td>lmc1</td><td>omr</td><td></td><td>vfct2</td><td>vfct1</td><td></td><td>upc</td><td>vcnt2</td><td>vcnt1</td> </tr> </table> <table border="1" style="width: 100%; text-align: center;"> <thead> <tr> <th colspan="2">bit</th> <th>Meaning when "0" is set.</th> <th>Meaning when "1" is set.</th> </tr> </thead> <tbody> <tr> <td>7</td> <td>omr</td> <td>Machine end compensation stop.</td> <td>Machine end compensation start.</td> </tr> </tbody> </table>	15	14	13	12	11	10	9	8	7	6	5	4	3	2	1	0	afll	zm2	afrg	afse	ovs2	ovs1	lmc2	lmc1	omr		vfct2	vfct1		upc	vcnt2	vcnt1	bit		Meaning when "0" is set.	Meaning when "1" is set.	7	omr	Machine end compensation stop.	Machine end compensation start.
15	14	13	12	11	10	9	8	7	6	5	4	3	2	1	0																												
afll	zm2	afrg	afse	ovs2	ovs1	lmc2	lmc1	omr		vfct2	vfct1		upc	vcnt2	vcnt1																												
bit		Meaning when "0" is set.	Meaning when "1" is set.																																								
7	omr	Machine end compensation stop.	Machine end compensation start.																																								
SV065	TLC	Machine end compensation amount	<p>The value calculated with the following expression is compensation amount.</p> $\text{Compensation amount } (\mu\text{m}) = \frac{\text{Command speed } F \text{ (mm/min)}^2 \times \text{SV065(TOF)}}{\text{Radius } R \text{ (mm)} \times 10^9}$ <p>Compensation amount can be calculated as mentioned above only in case of open loop. Determine the actual value during adjustment because the value is changed due to spring constant of the actual machine.</p> <p>When not using, set to "0".</p> <p style="text-align: right;">0 to 32767</p>																																								

(3) Adjustment method

- 1) With CNC sampling, confirm that the roundness of the motor end is good enough.
- 2) On this condition, measure the high-speed and low-speed round path without machine compensation.
The difference between high-speed round path and low-speed round path is the error amount swelled due to spring action. Therefore, the amount is specified as a compensation amount. When using grid encoder, determine the value as mentioned above.
When using RENISHAW DBB, the circular path cannot be compared as the value is not outputted by absolute coordinate but by related coordinate. In this case, the difference between the longer oval radius and shorter oval radius is specified as axis compensation amount.
- 3) Input the value calculated in (2) and measure the high-speed round path. In case that the oval still remains, increase or decrease the setting value by 1/10.
Confirm that there is no problem in low-speed round path.

Examples of the speed used when determining the machine end compensation amount.

	When using a grid encoder	When using RENISHAW DDB	Acceleration
Low-speed (standard)	R25mmF500mm/min	R100mmF1000mm/min	0.00028G
High-speed (when determining compensation amount)	R25mmF10000mm/min	R100mmF20000mm/min	0.11G

[Note1] Do not input remarkably large value in machine end compensation amount parameter (SV065), or the vibration is caused even during a stop.

[Note 2] In the machine end compensation amount (SV065), the values are inputted with both decimal notation and hexadecimal notation. When calculating or setting the value with the setting method explained in (2), the value has to be inputted with decimal notation. If the parameter is specified to be inputted with hexadecimal notation, convert the decimal value to hexadecimal value and input the result. (as of 1/NOV/2001)

9. Collision detection (NC lathe)

The purpose of the collision detection function is to detect a collision quickly and decelerate to a stop. This suppresses and prevents the excessive torque generated to the machine tool. Impact during a collision cannot be prevented even when the collision detection function is used, so this function does not guarantee that the machine will not break nor does not guarantee the machine accuracy after a collision. Thus, an attention has to be paid as conventional to prevent machine collisions from occurring.

The collision detection is performed with the following two methods. In either method, the servo alarm will occur after deceleration to a stop.

(1) Method 1

The required torque is calculated from the position command issued from the NC. The disturbance torque exceeds the collision detection level set with the parameters, the axis will decelerate to a stop with at the maximum torque of the motor. The method 1 is available only when SHG control is used. (If SHG control is not used, the load alarm <58/59> will occur immediately.)

In the method 1, the collision detection level during rapid traverse feed and that during cutting feed can be set individually. Calculate the collision detection level during cutting feed by increasing that during rapid traverse feed by 0 to 7 times (with an integral number). When setting to "0" times, the collision detection method 1 during cutting feed will be disabled.

(2) Method 2

When the current command reaches the motor's maximum current, the axis will decelerate to a stop with at the maximum torque of the driver. After decelerating to a stop, an alarm will occur and the system is stopped.

However, this can be ignored by setting the servo parameter SV035:SSF4/cl2n to "1".

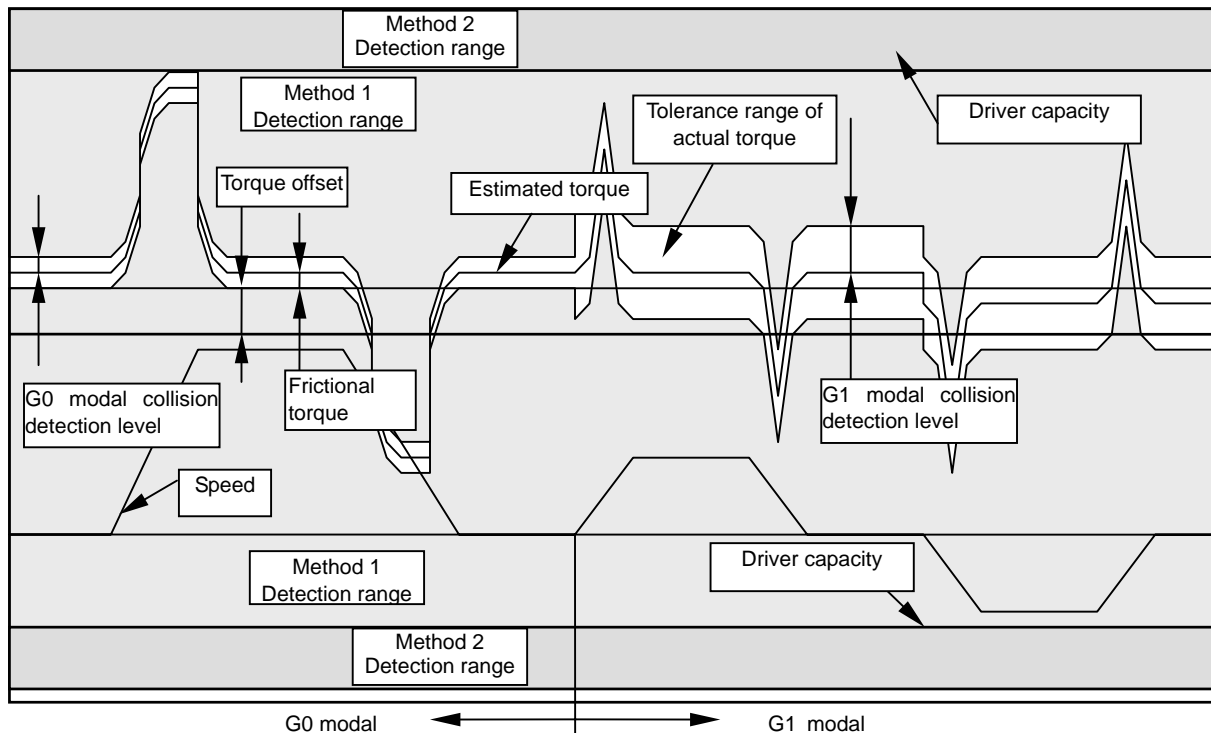

<Setting and adjustment method>

1. Confirm that SHG control is being used.
2. SV032: TOF Torque offset
Move the axis to be adjusted with JOG etc. by F1000mm/min and check the load current in the [I/F diagnosis screen, servo monitor]. If the current load during the movement is positive, check the maximum load current. If the current load during the movement is negative, check the minimum load current. Then, set the average of both + and – direction.
3. SV045: TRUB Frictional torque
Move the axis to be adjusted with JOG etc. by F1000mm/min and check the load current in the [I/F diagnosis screen, servo monitor]. Set the absolute position subtracting the current load value during the movement toward – direction from the current load value during the movement toward + direction and dividing the result in two.
4. SV059: TCNV Torque estimated gain
Set the parameter SV035:SSF4/clt(bitF) of the axis to be adjusted to “1”.
Move the axis to be adjusted to both direction with JOG etc. at the maximum rapid traverse rate until MPOF display in the [I/F diagnosis screen, servo monitor] becomes stable.
Set displayed value of MPOF in the [I/F diagnosis screen, servo monitor] .
Set SV035:SSF4/clt(bitF) back to “0”.
5. SV035:SSF4/cl2n(bitB)
Set “1” in case that the acceleration/deceleration time constant is short and current is limited.
6. SV060: TLMT Collision detection level (Method 1 / during G0 modal)
First of all, set “100”. (Set SV035:SSF4/clet to “1”, and the estimated disturbance torque peak value for the last 2 second is displayed. Refer to the value when setting. The displayed value is leveled off, therefore, set the doubled value of the displayed value first.)
Perform rapid traverse feed at the maximum feedrate without load. If an alarm occurs, raise the setting value by approximately 20.
If an alarm does not occur, lower the setting value by approximately 10.
Set the value increased the limit value by 1.5 times at where no alarm occurs.
7. SV035:SSF4/clG1(bit12 14)
Divide the maximum cutting load by the setting value of SV060:TLMT. Set the result (by rounding up a decimal place).
(Example) In case of maximum cutting load: 200% , SV060: TLMT setting value: 80%
200/80=2.5 → If the setting value is “3”, set “3xxx” in SV035:SSF4

No.	Abbrev	Parameter name	Explanation																																																								
SV035	SSF4	Special servo function selection 4	<p>The following parameters are used for the collision detection.</p> <table border="1" style="width: 100%; text-align: center;"> <tr> <td>15</td><td>14</td><td>13</td><td>12</td><td>11</td><td>10</td><td>9</td><td>8</td><td>7</td><td>6</td><td>5</td><td>4</td><td>3</td><td>2</td><td>1</td><td>0</td> </tr> <tr> <td colspan="2">clt</td> <td colspan="2">clG1</td> <td colspan="2">cl2n</td> <td colspan="2">clet</td> <td colspan="2">cltq</td> <td colspan="3">iup</td> <td colspan="3">tdt</td> </tr> </table> <table border="1" style="width: 100%; margin-top: 10px;"> <thead> <tr> <th>bit</th> <th></th> <th>Meaning when “0” is set.</th> <th>Meaning when “1” is set.</th> </tr> </thead> <tbody> <tr> <td>8,9</td> <td>cltq</td> <td>Set the deceleration torque during collision detection.</td> <td></td> </tr> <tr> <td>10</td> <td>clet</td> <td>Setting for normal use.</td> <td>The estimated disturbance torque peak value for the last 2 seconds is displayed in MPOF, servo monitor screen.</td> </tr> <tr> <td>11</td> <td>cl2n</td> <td>Setting for normal use.</td> <td>Disable collision detection method 5.</td> </tr> <tr> <td>12 to 14</td> <td>clG1</td> <td>Collision detection method 1: Set the collision detection level during G1 modal. When “0” is set: The collision detection during method 1 G1 modal is not carried out. When “1 to 7” is set: Specify the value increased the collision detection level during method 1 G0 modal by several times as the collision detection level during method 1 G1 modal.</td> <td></td> </tr> <tr> <td>15</td> <td>clt</td> <td>Setting for normal use.</td> <td>SV059: A standard for TCNV setting value is displayed in MPOF, servo monitor screen.</td> </tr> </tbody> </table>	15	14	13	12	11	10	9	8	7	6	5	4	3	2	1	0	clt		clG1		cl2n		clet		cltq		iup			tdt			bit		Meaning when “0” is set.	Meaning when “1” is set.	8,9	cltq	Set the deceleration torque during collision detection.		10	clet	Setting for normal use.	The estimated disturbance torque peak value for the last 2 seconds is displayed in MPOF, servo monitor screen.	11	cl2n	Setting for normal use.	Disable collision detection method 5.	12 to 14	clG1	Collision detection method 1: Set the collision detection level during G1 modal. When “0” is set: The collision detection during method 1 G1 modal is not carried out. When “1 to 7” is set: Specify the value increased the collision detection level during method 1 G0 modal by several times as the collision detection level during method 1 G1 modal.		15	clt	Setting for normal use.	SV059: A standard for TCNV setting value is displayed in MPOF, servo monitor screen.
15	14	13	12	11	10	9	8	7	6	5	4	3	2	1	0																																												
clt		clG1		cl2n		clet		cltq		iup			tdt																																														
bit		Meaning when “0” is set.	Meaning when “1” is set.																																																								
8,9	cltq	Set the deceleration torque during collision detection.																																																									
10	clet	Setting for normal use.	The estimated disturbance torque peak value for the last 2 seconds is displayed in MPOF, servo monitor screen.																																																								
11	cl2n	Setting for normal use.	Disable collision detection method 5.																																																								
12 to 14	clG1	Collision detection method 1: Set the collision detection level during G1 modal. When “0” is set: The collision detection during method 1 G1 modal is not carried out. When “1 to 7” is set: Specify the value increased the collision detection level during method 1 G0 modal by several times as the collision detection level during method 1 G1 modal.																																																									
15	clt	Setting for normal use.	SV059: A standard for TCNV setting value is displayed in MPOF, servo monitor screen.																																																								

No.	Abbrev.	Parameter name	Unit	Explanation	Setting range
SV032	TOF	Torque offset	Stall% (rated current%)	Set the unbalance torque amount of the axis which has unbalance torque including vertical axis by a percentage (%) to the stall rated current.	-100 to 100
SV045	TRUB	Current compensation / frictional torque	Stall% (rated current%)	Set the frictional torque for using the collision detection function by a percentage to the stall rated current. 8 low-order digits are used. When not using collision detection function, set "0".	0 to 100
SV059	TCNV	Torque estimated gain		Set the torque estimated gain when using collision detection function. If setting SV035:SSF4/clt to "1", the standard for the setting value can be displayed in MPOF, monitor screen.	0 to 32767
SV060	TLMT	G0 collision detection level	Stall% (rated current%)	Set the collision detection level of method 1 G0 modal when using the collision detection function. When "0" is set, collision detection functions will not function.	0 to 100

[Note 1] Even if collision detection function is enabled, a machine can be troubled due to machine collision or its accuracy cannot be guaranteed. Thus, conventional caution is required to prevent machine collisions from occurring.

[Note 2] Set the collision detection level with an allowance to avoid in correct detections.

[Note 3] When a motor or a detector is changed as for maintenance, adjust the parameters concerning with collision detection function again.

[Note 4] SV059:TCNV torque estimated gain has to be changed if the detection resolution is changed when changing detector or if position control system (if closed loop is changed to semi-closed loop) is changed.

APPENDIX A

Standard Parameter List by Each Motor (HC Series)

Motor	HC Standard Motor															S Drive Unit Motor					
	HC 52	HC 53	HC 102	HC 103	HC 152	HC 153	HC 202	HC 203	HC 352	HC 353	HC 452	HC 453	HC 702	HC 703	HC 902	HC 353	HC 452	HC 453	HC 702	HA-LF15K	
Diver	05	05	10	10	20	20	20	35	35	45	45	70	70	90	90	45S	45S	70S	70S	150	
SV001	-	-	-	-	-	-	-	-	-	-	-	-	-	-	-	-	-	-	-	-	-
SV002	-	-	-	-	-	-	-	-	-	-	-	-	-	-	-	-	-	-	-	-	-
SV003	47	47	47	47	47	47	47	47	47	47	47	47	47	47	47	47	47	47	47	47	33
SV004	125	125	125	125	125	125	125	125	125	125	125	125	125	125	125	125	125	125	125	125	86
SV005	100	150	100	150	150	150	200	200	200	200	200	200	200	200	200	200	200	200	200	200	150
SV006	0	0	0	0	0	0	0	0	0	0	0	0	0	0	0	0	0	0	0	0	0
SV007	0	0	0	0	0	0	0	0	0	0	0	0	0	0	0	0	0	0	0	0	0
SV008	1900	1900	1900	1900	1900	1900	1900	1900	1900	1900	1900	1900	1900	1900	1900	1900	1900	1900	1900	1900	1900
SV009	4096	4096	4096	4096	4096	4096	4096	4096	4096	4096	4096	4096	4096	4096	4096	4096	4096	4096	4096	4096	4096
SV010	4096	4096	4096	4096	4096	4096	4096	4096	4096	4096	4096	4096	4096	4096	4096	4096	4096	4096	4096	4096	4096
SV011	768	768	768	768	768	768	768	768	768	768	768	768	768	768	768	768	768	768	768	768	768
SV012	768	768	768	768	768	768	768	768	768	768	768	768	768	768	768	768	768	768	768	768	768
SV013	500	500	500	500	500	500	500	500	500	500	500	500	500	500	500	500	500	500	500	500	500
SV014	500	500	500	500	500	500	500	500	500	500	500	500	500	500	500	500	500	500	500	500	500
SV015	100	100	100	100	100	100	100	100	100	100	100	100	100	100	100	100	100	100	100	100	100
SV016	0	0	0	0	0	0	0	0	0	0	0	0	0	0	0	0	0	0	0	0	0
SV017	0000	0000	0000	0000	0000	0000	0000	0000	0000	0000	0000	0000	0000	0000	0000	1000	1000	1000	1000	1000	0000
SV018	-	-	-	-	-	-	-	-	-	-	-	-	-	-	-	-	-	-	-	-	-
SV019	-	-	-	-	-	-	-	-	-	-	-	-	-	-	-	-	-	-	-	-	-
SV020	-	-	-	-	-	-	-	-	-	-	-	-	-	-	-	-	-	-	-	-	-
SV021	60	60	60	60	60	60	60	60	60	60	60	60	60	60	60	60	60	60	60	60	60
SV022	150	150	150	150	150	150	150	150	150	150	150	150	150	150	150	150	150	150	150	150	150
SV023	6	6	6	6	6	6	6	6	6	6	6	6	6	6	6	6	6	6	6	6	6
SV024	50	50	50	50	50	50	50	50	50	50	50	50	50	50	50	50	50	50	50	50	50
SV025	xxB0	xxC0	xxB1	xxC1	xxB2	xxC2	xxB3	xxC3	xxB4	xxC4	xxB5	xxC5	xxB6	xxC6	xxB7	xxA4	xx95	xxA5	xx96	xx2D	
SV026	6	6	6	6	6	6	6	6	6	6	6	6	6	6	6	6	6	6	6	6	6
SV027	4000	4000	4000	4000	4000	4000	4000	4000	4000	4000	4000	4000	4000	4000	4000	4000	4000	4000	4000	4000	4000
SV028	0	0	0	0	0	0	0	0	0	0	0	0	0	0	0	0	0	0	0	0	0
SV029	0	0	0	0	0	0	0	0	0	0	0	0	0	0	0	0	0	0	0	0	0
SV030	0	0	0	0	0	0	0	0	0	0	0	0	0	0	0	0	0	0	0	0	0
SV031	0	0	0	0	0	0	0	0	0	0	0	0	0	0	0	0	0	0	0	0	0
SV032	0	0	0	0	0	0	0	0	0	0	0	0	0	0	0	0	0	0	0	0	0
SV033	0000	0000	0000	0000	0000	0000	0000	0000	0000	0000	0000	0000	0000	0000	0000	0000	0000	0000	0000	0000	0000
SV034	0003	0003	0003	0003	0003	0003	0003	0003	0003	0003	0003	0003	0003	0003	0003	0003	0003	0003	0003	0003	0003
SV035	0000	0000	0000	0000	0040	0040	0040	0040	0040	0040	0040	0040	0040	0040	0040	0040	0040	0040	0040	0040	0000
SV036	0000	0000	0000	0000	0000	0000	0000	0000	0000	0000	0000	0000	0000	0000	0000	0000	0000	0000	0000	0000	0000
SV037	0	0	0	0	0	0	0	0	0	0	0	0	0	0	0	0	0	0	0	0	0
SV038	0	0	0	0	0	0	0	0	0	0	0	0	0	0	0	0	0	0	0	0	0
SV039	0	0	0	0	0	0	0	0	0	0	0	0	0	0	0	0	0	0	0	0	0
SV040	0	0	0	0	0	0	10240	10240	10240	10240	10240	10240	10240	10240	10240	10240	10240	10240	10240	10240	10240
SV041	0	0	0	0	0	0	0	0	0	0	0	0	0	0	0	0	0	0	0	0	0
SV042	0	0	0	0	0	0	0	0	0	0	0	0	0	0	0	0	0	0	0	0	0
SV043	0	0	0	0	0	0	0	0	0	0	0	0	0	0	0	0	0	0	0	0	0
SV044	0	0	0	0	0	0	0	0	0	0	0	0	0	0	0	0	0	0	0	0	0
SV045	0	0	0	0	0	0	0	0	0	0	0	0	0	0	0	0	0	0	0	0	0
SV046	0	0	0	0	0	0	0	0	0	0	0	0	0	0	0	0	0	0	0	0	0
SV047	100	100	100	100	100	100	100	100	100	100	100	100	100	100	100	100	100	100	100	100	100
SV048	0	0	0	0	0	0	0	0	0	0	0	0	0	0	0	0	0	0	0	0	0
SV049	15	15	15	15	15	15	15	15	15	15	15	15	15	15	15	15	15	15	15	15	15
SV050	0	0	0	0	0	0	0	0	0	0	0	0	0	0	0	0	0	0	0	0	0
SV051	0	0	0	0	0	0	0	0	0	0	0	0	0	0	0	0	0	0	0	0	0
SV052	0	0	0	0	0	0	0	0	0	0	0	0	0	0	0	0	0	0	0	0	0
SV053	0	0	0	0	0	0	0	0	0	0	0	0	0	0	0	0	0	0	0	0	0
SV054	0	0	0	0	0	0	0	0	0	0	0	0	0	0	0	0	0	0	0	0	0
SV055	0	0	0	0	0	0	0	0	0	0	0	0	0	0	0	0	0	0	0	0	0
SV056	0	0	0	0	0	0	0	0	0	0	0	0	0	0	0	0	0	0	0	0	0
SV057	281	281	281	281	281	281	281	281	281	281	281	281	281	281	281	281	281	281	281	281	187
SV058	0	0	0	0	0	0	0	0	0	0	0	0	0	0	0	0	0	0	0	0	0
SV059	0	0	0	0	0	0	0	0	0	0	0	0	0	0	0	0	0	0	0	0	0
SV060	0	0	0	0	0	0	0	0	0	0	0	0	0	0	0	0	0	0	0	0	0
SV061	0	0	0	0	0	0	0	0	0	0	0	0	0	0	0	0	0	0	0	0	0
SV062	0	0	0	0	0	0	0	0	0	0	0	0	0	0	0	0	0	0	0	0	0
SV063	0	0	0	0	0	0	0	0	0	0	0	0	0	0	0	0	0	0	0	0	0
SV064	0	0	0	0	0	0	0	0	0	0	0	0	0	0	0	0	0	0	0	0	0
OS1	3600	3600	3600	3600	3600	3600	3000	3600	3000	3600	3000	3600	3000	3600	3000	3600	3000	3600	3000	3600	3000
OS2	3600	4200	3600	4200	3600	4200	3000	4200	3000	4200	3000	4200	3000	4200	3000	4200	3000	4200	3000	4200	3000

APPENDIX B

Standard Parameter List by Each Motor (HC-H Series)

Motor	HC-H Standard Motor														
	HC - H103	HC - H152	HC - H153	HC - H202	HC - H203	HC - H352	HC - H353	HC - H452	HC - H453	HC - H702	HC - H703	HC - H902	HC - H903	HC - H1102	HC - H1103
Diver	10	20	20	20	35	35	45	45	70	70	90	90	110	150	150
SV001	-	-	-	-	-	-	-	-	-	-	-	-	-	-	-
SV002	-	-	-	-	-	-	-	-	-	-	-	-	-	-	-
SV003	47	47	47	47	47	47	47	47	47	47	47	47	47	47	47
SV004	125	125	125	125	125	125	125	125	125	125	125	125	125	125	125
SV005	75	50	75	150	150	150	150	150	150	150	150	150	150	150	150
SV006	0	0	0	0	0	0	0	0	0	0	0	0	0	0	0
SV007	0	0	0	0	0	0	0	0	0	0	0	0	0	0	0
SV008	1900	1900	1900	1900	1900	1900	1900	1900	1900	1900	1900	1900	1900	1900	1900
SV009	4096	4096	4096	4096	4096	4096	4096	4096	4096	4096	4096	4096	4096	4096	4096
SV010	4096	4096	4096	4096	4096	4096	4096	4096	4096	4096	4096	4096	4096	4096	4096
SV011	1280	1024	1280	1024	1024	1024	768	1024	768	768	768	768	768	768	768
SV012	1280	1024	1280	1024	1024	1024	768	1024	768	768	768	768	768	768	768
SV013	500	500	500	500	500	500	500	500	500	500	500	500	500	500	500
SV014	500	500	500	500	500	500	500	500	500	500	500	500	500	500	500
SV015	100	100	100	100	100	100	100	100	100	100	100	100	100	100	100
SV016	0	0	0	0	0	0	0	0	0	0	0	0	0	0	0
SV017	2008	2008	2008	2008	2008	2008	2008	2008	2008	2008	2008	2008	2008	2008	2008
SV018	-	-	-	-	-	-	-	-	-	-	-	-	-	-	-
SV019	-	-	-	-	-	-	-	-	-	-	-	-	-	-	-
SV020	-	-	-	-	-	-	-	-	-	-	-	-	-	-	-
SV021	60	60	60	60	60	60	60	60	60	60	60	60	60	60	60
SV022	150	150	150	150	150	150	150	150	150	150	150	150	150	150	150
SV023	6	6	6	6	6	6	6	6	6	6	6	6	6	6	6
SV024	50	50	50	50	50	50	50	50	50	50	50	50	50	50	50
SV025	xxC1	xxB2	xxC2	xxB3	xxC3	xxB4	xxC4	xxB5	xxC5	xxB6	xxC6	xxB7	xxC7	xxB8	xxC8
SV026	6	6	6	6	6	6	6	6	6	6	6	6	6	6	6
SV027	4000	4000	4000	4000	4000	4000	4000	4000	4000	4000	4000	4000	4000	4000	4000
SV028	0	0	0	0	0	0	0	0	0	0	0	0	0	0	0
SV029	0	0	0	0	0	0	0	0	0	0	0	0	0	0	0
SV030	0	0	0	0	0	0	0	0	0	0	0	0	0	0	0
SV031	0	0	0	0	0	0	0	0	0	0	0	0	0	0	0
SV032	0	0	0	0	0	0	0	0	0	0	0	0	0	0	0
SV033	0010	0010	0010	0010	0010	0010	0010	0010	0010	0010	0010	0010	0010	0010	0010
SV034	0000	0000	0000	0000	0000	0000	0000	0000	0000	0000	0000	0000	0000	0000	0000
SV035	0000	0000	0000	0000	0000	0000	0000	0000	0000	0000	0000	0000	0000	0000	0000
SV036	0000	0000	0000	0000	0000	0000	0000	0000	0000	0000	0000	0000	0000	0000	0000
SV037	0	0	0	0	0	0	0	0	0	0	0	0	0	0	0
SV038	0	0	0	0	0	0	0	0	0	0	0	0	0	0	0
SV039	0	0	0	0	0	0	0	0	0	0	0	0	0	0	0
SV040	0	0	0	0	0	0	0	0	0	0	0	0	0	0	0
SV041	0	0	0	0	0	0	0	0	0	0	0	0	0	0	0
SV042	0	0	0	0	0	0	0	0	0	0	0	0	0	0	0
SV043	0	0	0	0	0	0	0	0	0	0	0	0	0	0	0
SV044	0	0	0	0	0	0	0	0	0	0	0	0	0	0	0
SV045	0	0	0	0	0	0	0	0	0	0	0	0	0	0	0
SV046	0	0	0	0	0	0	0	0	0	0	0	0	0	0	0
SV047	100	100	100	100	100	100	100	100	100	100	100	100	100	100	100
SV048	0	0	0	0	0	0	0	0	0	0	0	0	0	0	0
SV049	15	15	15	15	15	15	15	15	15	15	15	15	15	15	15
SV050	0	0	0	0	0	0	0	0	0	0	0	0	0	0	0
SV051	0	0	0	0	0	0	0	0	0	0	0	0	0	0	0
SV052	0	0	0	0	0	0	0	0	0	0	0	0	0	0	0
SV053	0	0	0	0	0	0	0	0	0	0	0	0	0	0	0
SV054	0	0	0	0	0	0	0	0	0	0	0	0	0	0	0
SV055	0	0	0	0	0	0	0	0	0	0	0	0	0	0	0
SV056	0	0	0	0	0	0	0	0	0	0	0	0	0	0	0
SV057	281	281	281	281	281	281	281	281	281	281	281	281	281	281	281
SV058	0	0	0	0	0	0	0	0	0	0	0	0	0	0	0
SV059	0	0	0	0	0	0	0	0	0	0	0	0	0	0	0
SV060	0	0	0	0	0	0	0	0	0	0	0	0	0	0	0
SV061	0	0	0	0	0	0	0	0	0	0	0	0	0	0	0
SV062	0	0	0	0	0	0	0	0	0	0	0	0	0	0	0
SV063	0	0	0	0	0	0	0	0	0	0	0	0	0	0	0
SV064	0	0	0	0	0	0	0	0	0	0	0	0	0	0	0
OS1	3600	2400	3600	2400	3600	2400	3600	2400	3600	2400	3600	2400	3600	3000	3600
OS2	3600	2400	3600	2400	3600	2400	3600	2400	3600	2400	3600	2400	3600	3000	3600

REPORT ON MDS-C1/CH-V1/V2 SERVO ADJUSTMENT FOR THE FIRST TIME

1. Date - Engineer: Section: Observer:

2. Specifications

SSO No.	SSO -	Initial (or original) parameter list No.	BN
Machine name		Machine number	Power supply type
axis drive unit type		axis drive unit serial No.	Servo motor type
axis drive unit type		axis drive unit serial No.	Servo motor type
axis drive unit type		axis drive unit serial No.	Servo motor type
axis drive unit type		axis drive unit serial No.	Servo motor type

3. Parameter check (These items shall be checked by a designer of the machine tool builder.)

axis	Max. load inertia kgcms ²	Acceleration/Deceleration time constant (m/sec)	Theoretical value	:
axis	Max. load inertia kgcms ²	Acceleration/Deceleration time constant (m/sec)	Theoretical value	:
axis	Max. load inertia kgcms ²	Acceleration/Deceleration time constant (m/sec)	Theoretical value	:
axis	Max. load inertia kgcms ²	Acceleration/Deceleration time constant (m/sec)	Theoretical value	:
axis	Max. load inertia kgcms ²	Acceleration/Deceleration time constant (m/sec)	Theoretical value	:

4. Speed loop gain (SV005)

Axis name	VGN limit	SV38 FHz	SV46 FHz2	SV33 SSF3	Adaptive filter	The third filter	Setting VGN

Note) Set the notch filter FHz (SV38) in case that the machine resonance occurs during VGN adjustment.

5. Position loop gain limit

Axis name	G0 Constant inclination disabled	G0 Constant inclination enabled	G64G1	G61.1G1	Disturbance observer function			Setting position loop gain
					JL(SV37)	OBS1(SV43)	OBS2 (SV44)	

Note) Set the disturbance observer in case that the low frequency current vibration between 10 and 20Hz occurs during SHG control.

The parameters to be set are JL(SV37), OBS1(SV43) and OBS2(SV44).

6. Rapid traverse acceleration/deceleration time constant

Axis name	Max. speed (M1)	Acceleration / deceleration time constant (M1)(mS)	Max. current value (%) (Converted to the stall current)	Max. current value of the motor specification (%)	Max. current value ratio of the motor specification (%)	Data No.	Judgment

7. In high-accuracy control mode

Max. speed (L74)	Time constant (L75)	Feed forward gain (S4)	S-pattern (K107)	Data No.	Judgment

8. Lost motion compensation function

Adjust when evaluating DDB measurement or synchronized tapping etc.

Axis name	Unbalance load	TOF(SV32)	LMC1(SV16)	LMC2(SV41)	LMCT(SV40)	LMCD(SV39)	Data No.
	Exists / Not Exist						
	Exists / Not Exist						
	Exists / Not Exist						
	Exists / Not Exist						

Note) Make sure to set the torque offset amount TOF(SV32) to the axis which has unbalanced load.

Set SSF1bit9=1 when carrying out the lost motion compensation.

Set "0" in LMC2, and adjust only when the protrusion amount increases depending on the direction.

Set LMCD(SV039) in case that the timing does not match correctly.

9. Closed loop overshooting compensation function

Adjust the speed loop delay compensation VIL(SV07) in the axis which causes overshooting in the closed loop system including a linear scale.

Axis name	VIL (SVO7)	SV17 (SPEC) Bit 1	SV51 (DFBT)

Note) Set SSF1bit9 =1 in the axis which causes droop during stop due to the VIL setting.

10. CVE current measurement

-Confirm referring to the current check manual BQN-N1-2097.

Measure by performing all axis simultaneous acceleration/deceleration (at the maximum rapid traverse rate) and confirm that the value is less than the tolerance.

(During)	Simultaneous acceleration / deceleration axis	Tolerance	Max. current during interpolation (%)	Max. current interpolation when not interpolating (%)	Data. No	Judgment
Acceleration		A	A (%)	A (%)		
Deceleration		A	A (%)	A (%)		
Acceleration		A	A (%)	A (%)		
Deceleration		A	A (%)	A (%)		

11. Conclusion

The official report on the result of above-mentioned measurement will be made by ____ / ____ / ____.

The parameters for the servo adjustment, SV61, SV62, SV63 and SV64, were set back to "0" which is the original setting.

12. Special mention

Check Sheet for the machine resonance suppression filter and speed loop gain limit

	1st machine resonance suppression filter (SV038)	Center frequency	Hz	Hz	Hz	Hz	Hz		
		Depth							
		0 (-)							
	Machine resonance frequency	4 (-12dB)							
		8 (-6dB)							
		C (-3dB)							
	Hz	Remarks							
		2nd machine resonance suppression filter (SV046)	Center frequency	Hz	Hz	Hz	Hz	Hz	
			Depth						
			0 (-)						
Machine resonance frequency		4 (-12dB)							
		8 (-6dB)							
		C (-3dB)							
Hz		Remarks							
Speed loop gain limit after an adaptive filter is used									
		1st machine resonance suppression filter (SV038)	Center frequency	Hz	Hz	Hz	Hz	Hz	
			Depth						
	0 (-)								
	Machine resonance frequency	4 (-12dB)							
		8 (-6dB)							
		C (-3dB)							
	Hz	Remarks							
		2nd machine resonance suppression filter (SV046)	Center frequency	Hz	Hz	Hz	Hz	Hz	
			Depth						
			0 (-)						
Machine resonance frequency		4 (-12dB)							
		8 (-6dB)							
		C (-3dB)							
Hz		Remarks							
Speed loop gain limit after an adaptive filter is used									
		1st machine resonance suppression filter (SV038)	Center frequency	Hz	Hz	Hz	Hz	Hz	
			Depth						
	0 (-)								
	Machine resonance frequency	4 (-12dB)							
		8 (-6dB)							
		C (-3dB)							
	Hz	Remarks							
		2nd machine resonance suppression filter (SV046)	Center frequency	Hz	Hz	Hz	Hz	Hz	
			Depth						
			0 (-)						
Machine resonance frequency		4 (-12dB)							
		8 (-6dB)							
		C (-3dB)							
Hz		Remarks							
Speed loop gain limit after an adaptive filter is used									

Revision history

Rev.	Date	Details
*	'2000-12-18	<p>New edition The following items have been rewrote since [MDS-B-V14/V24 adjustment manual] was issued.</p> <ul style="list-style-type: none"> -Description was changed for MDS-C1 series. -Explanation about speed feedback filter (2250Hz machine resonance filter) was added. -Adjustment procedures during dimension interpolation in the NC lathe were added. -S drive unit motor was added to a standard parameter. -HA-LK15K was added to a standard parameter.
A	'2002-6-25	<p>The descriptions of following items were added.</p> <ul style="list-style-type: none"> -Various speed loop gain function -HC-H series speed loop gain standard setting value -HC-H series max. current value during acceleration/deceleration time constant adjustment by each motor -HC-H series standard parameter

