



GE Fanuc Automation

Computer Numerical Control Products

Series 16 / 18 / 160 / 180 – Model C

Parameter Manual

GFZ-62760EN/01

December 1995

Warnings, Cautions, and Notes as Used in this Publication

Warning

Warning notices are used in this publication to emphasize that hazardous voltages, currents, temperatures, or other conditions that could cause personal injury exist in this equipment or may be associated with its use.

In situations where inattention could cause either personal injury or damage to equipment, a Warning notice is used.

Caution

Caution notices are used where equipment might be damaged if care is not taken.

Note

Notes merely call attention to information that is especially significant to understanding and operating the equipment.

This document is based on information available at the time of its publication. While efforts have been made to be accurate, the information contained herein does not purport to cover all details or variations in hardware or software, nor to provide for every possible contingency in connection with installation, operation, or maintenance. Features may be described herein which are not present in all hardware and software systems. GE Fanuc Automation assumes no obligation of notice to holders of this document with respect to changes subsequently made.

GE Fanuc Automation makes no representation or warranty, expressed, implied, or statutory with respect to, and assumes no responsibility for the accuracy, completeness, sufficiency, or usefulness of the information contained herein. No warranties of merchantability or fitness for purpose shall apply.

PREFACE

The mode covered by this manual, and their abbreviations are :

Product Name	Abbreviations	
FANUC Series 16-TC	16-TC	T series or T series (two-path control) *1
FANUC Series 160-TC	160-TC	
FANUC Series 16-MC	16-MC	M series or M series (two-path control) *1
FANUC Series 160-MC	160-MC	
FANUC Series 18-TC	18-TC	T series or T series (two-path control) *1
FANUC Series 180-TC	180-TC	
FANUC Series 18-MC	18-MC	M series
FANUC Series 180-MC	180-MC	

Note

Some functions described in this manual may not be applied to some products.
For details, refer to the DESCRIPTIONS (B-62752JA).

The table below lists manuals related to MODEL C of Series 16, Series 18, Series 160, Series 180. In the table, this manual is marked with an asterisk (*).

Table 1 Related manuals

Manual name	Specification Number	
DESCRIPTIONS	B-62752EN	
CONNECTION MANUAL (Hardware)	B-62753EN	
CONNECTION MANUAL (Function)	B-62753EN-1	
OPERATOR'S MANUAL FOR LATHE	B-62754EN	
OPERATOR'S MANUAL FOR MACHINE CENTER	B-62764EN	
MAINTENANCE MANUAL	B-62755EN	
PARAMETER MANUAL	B-62760EN	*
PROGRAMMING MANUAL (Macro Compiler/Macro Executer)	B-61803E-1	
FAPT MACRO COMPILER PROGRAMMING MANUAL	B-66102E	
FANUC Super CAP T OPERATOR'S MANUAL	B-62444E-1	
FANUC Super CAP M OPERATOR'S MANUAL	B-62154E	

Table 1 Related manuals

Manual name	Specification Number	
FANUC Super CAP M PROGRAMMING MANUAL	B-62153E	
CONVERSATIONAL AUTOMATIC PROGRAMMING FUNCTION I FOR LATHE OPERATOR'S MANUAL	B-61804E-1	
CONVERSATIONAL AUTOMATIC PROGRAMMING FUNCTION FOR LATHE OPERATOR'S MANUAL	B-61804E-2	

1. DISPLAYING PARAMETERS	1
2. SETTING PARAMETERS FROM MDI	3
3. INPUTTING AND OUTPUTTING PARAMETERS THROUGH THE READER/PUNCHER INTERFACE	5
3.1 OUTPUTTING PARAMETERS THROUGH THE READER/PUNCHER INTERFACE	6
3.2 INPUTTING PARAMETERS THROUGH THE READER/PUNCHER INTERFACE	7
4. DESCRIPTION OF PARAMETERS	8
4.1 PARAMETERS OF SETTING	10
4.2 PARAMETERS OF READER/PUNCHER INTERFACE, REMOTEBUFFER, DNC1, DNC2, AND M-NET INTERFACE	14
4.3 PARAMETERS OF AXIS CONTROL/ INCREMENT SYSTEM	32
4.4 PARAMETERS OF COORDLNATES	48
4.5 PARAMETERS OF STROKE LIMIT	53
4.6 PARAMETERS OF THE CHUCK AND TAILSTOCK BARRIER (16-TB)	56
4.7 PARAMETERS OF FEEDRATE	60
4.8 PARAMETERS OF ACCELERATION/ DECELERATION CONTROL	72
4.9 PARAMETERS OF SERVO	90
4.10 PARAMETERS OF DI/DO	106
4.11 PARAMETERS OF CRT/MDI, DISPLAY, AND EDIT	110
4.12 PARAMETERS OF PROGRAMS	128
4.13 PARAMETERS OF PITCH ERROR COMPENSATION	136
4.14 PARAMETERS OF SPINDLE CONTROL	141
4.15 PARAMETERS OF TOOL COMPENSATION	177
4.16 PARAMETERS RELATED TO GRINDING-WHEEL WEAR COMPENSATION	185
4.17 PARAMETERS OF CANNED CYCLES	186
4.18 PARAMETERS OF RIGID TAPPING	197
4.19 PARAMETERS OF SCALING/COORDINATE ROTATION	210
4.20 PARAMETERS OF UNI-DIRECTIONAL POSITIONING	212
4.21 PARAMETERS OF POLAR COORDINATE INTERPOLATION	213
4.22 PARAMETERS OF NORMAL DIRECTION CONTROL	215
4.23 PARAMETERS OF INDEXING INDEX TABLE	217
4.24 PARAMETER FOR INVOLUTE INTERPOLATION	219
4.25 EXPONENTIAL INTERPOLATION PARAMETERS	220
4.26 STRAIGHTNESS COMPENSATION PARAMETERS	221
4.27 PARAMETERS OF CUSTOM MACROS	223
4.28 PARAMETERS RELATED TO PATTERN DATA INPUT	230
4.29 PARAMETER OF SKIP FUNCTION	231
4.30 PARAMETERS OF AUTOMATIC TOOL COMPENSATION (16-TB) AND AUTOMATIC TOOL LENGTH COMPENSATION (16-MB)	236
4.31 PARAMETER OF EXTERNAL DATA INPUT/OUTPUT	238
4.32 PARAMETERS OF GRAPHIC DISPLAY	238
4.33 PARAMETERS OF DISPLAYING OPERATION TIME AND NUMBER OF PARTS	243

4.34	PARAMETERS OF TOOL LIFE MANAGEMENT	246
4.35	PARAMETERS OF POSITION SWITCH FUNCTIONS	249
4.36	PARAMETERS OF MANUAL OPERATION AND AUTOMATIC OPERATION	252
4.37	PARAMETERS OF MANUAL HANDLE FEED, HANDLE INTERRUPTION AND HANDLE FEED IN TOOL AXIAL DIRECTION	253
4.38	PARAMETERS RELATED TO BUTT-TYPE REFERENCE POSITION SETTING	257
4.39	PARAMETERS OF SOFTWARE OPERATOR'S PANEL	259
4.40	PARAMETERS OF PROGRAM RESTART	262
4.41	PARAMETERS OF HIGH-SPEED MACHINING (HIGH-SPEED CYCLE MACHINING/HIGH-SPEED REMOTE BUFFER)	263
4.42	PARAMETERS OF POLYGON TURNING	266
4.43	PARAMETERS OF THE EXTERNAL PULSE INPUT	270
4.44	PARAMETERS OF THE HOBBING MACHINE AND ELECTRONIC GEAR BOX	271
4.45	PARAMETERS OF AXIS CONTROL BY PMC	276
4.46	PARAMETERS OF TWO-PATH CONTROL	281
4.47	PARAMETERS FOR CHECKING INTERFERENCE BETWEEN TOOL POSTS (TWO-PATH CONTROL)	282
4.48	PARAMETERS RELATED TO PATH AXIS REASSIGNMENT	284
4.49	PARAMETERS FOR ANGULAR AXIS CONTROL	296
4.50	PARAMETERS RELATED TO B-AXIS CONTROL	297
4.51	PARAMETERS OF SIMPLE SYNCHRONOUS CONTROL	301
4.52	PARAMETERS OF RELATED TO CHECK TERMINATION	306
4.53	CHOPPING PARAMETERS	307
4.54	PARAMETERS OF HIGH-SPEED HIGH-PRECISION CONTOUR CONTROL BY RISC (16-MB)	310
4.55	OTHER PARAMETERS	317
4.56	PARAMETERS FOR MAINTENANCE	320

APPENDIXES

A. CHARACTER CODE LIST	321
-------------------------------------	------------

1 DISPLAYING PARAMETERS

Follow the procedure below to display parameters.

- (1) Press the SYSTEM function key on the CRT/MDI as many times as required, or alternatively, press the SYSTEM function key once, then the PARAM section select soft key. The parameter screen is then selected.

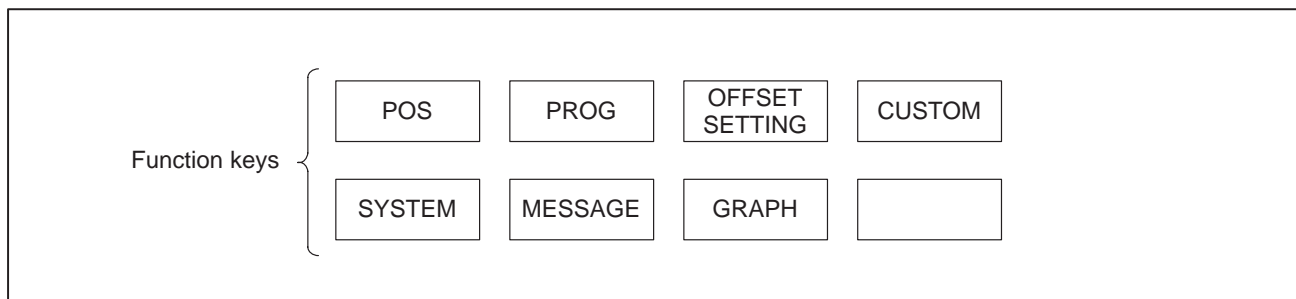

Note
Pressing the SYSTEM function key displays section select soft keys including PARAM.

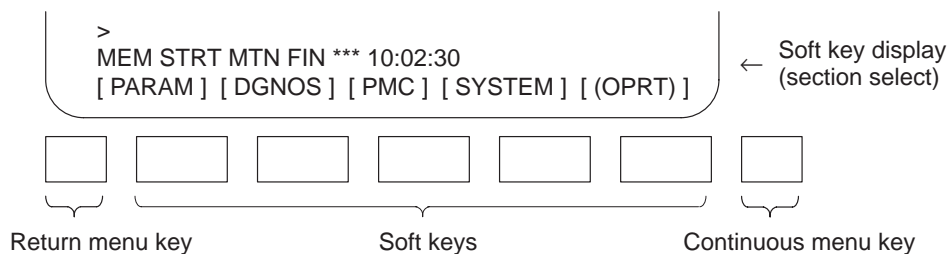

- (2) The parameter screen consists of multiple pages. Use step (a) or (b) to display the page that contains the parameter you want to display.
 - (a) Use the page select key or the cursor move keys to display the desired page.
 - (b) Enter the data number of the parameter you want to display from the keyboard, then press the **[NO.SRH]** soft key. The parameter page containing the specified data number appears with the cursor positioned at the data number. (The data is displayed in reverse video.)

Note
If key entry is started with the section select soft keys displayed, they are replaced automatically by operation select soft keys including **[NO.SRH]**. Pressing the **[(OPRT)]** soft key can also cause the operation select keys to be displayed.

```

>
MEM STRT MTN FIN *** 10:02:34
[ NO. SRH ] [ ON:1 ] [ OFF:0 ] [ +INPUT ] [ INPUT ]
    
```

← Data entered from the keyboard
 ← Soft key display (section select)

```

PARAMETER (FEEDRATE)          O0001 N00010

1401      RDR                JZR      RPD
      0    0    0    0    0    0    0    0
1402                        JRV
      0    0    0    0    0    0    0    0
1410  DRY RUN FEEDRATE      10000
1412
1420  RAPID FEEDRATE      X      15000
                        Y      15000
                        Z      15000

>
MEM STRT MTN FIN *** 10:02:35
[ NO. SRH ] [ ON:1 ] [ OFF:0 ] [ +INPUT ] [ INPUT ]
    
```

Cursor



2

SETTING PARAMETERS FROM MDI

Follow the procedure below to set parameters.

- (1) Place the NC in the MDI mode or the emergency stop state.
- (2) Follow the substeps below to enable writing of parameters.
 1. To display the setting screen, press the **SETTING** function key as many times as required, or alternatively press the **SETTING** function key once, then the **SETTING** section select soft key. The first page of the setting screen appears.
 2. Position the cursor on “PARAMETER WRITE” using the cursor move keys.

SETTING (HANDY)	O0001	N00010
PARAMETER WRITE =	0	(0:DISABLE 1:ENABLE)
TV CHECK =	0	(0:OFF 1:ON)
PUNCH CODE =	0	(0:EIA 1:ISO)
INPUT UNIT =	0	(0:MM 1:INCH)
I/O CHANNEL =	0	(0-3:CHANNEL NO.)

3. Press the **[OPRT]** soft key to display operation select soft keys.

> 1410	
MDI STOP *** ** 10:03:02	
[NO. SRH] [ON:1] [OFF:0] [+INPUT] [INPUT]	

← Data entered from the keyboard
 ← Soft key display (section select)

4. To set “PARAMETER WRITE=” to 1, press the ON:1 soft key, or alternatively enter 1 and press the **INPUT** soft key. From now on, the parameters can be set. At the same time an alarm condition (P/S100 PARAMETER WRITE ENABLE) occurs in the CNC.
- (3) To display the parameter screen, press the **SYSTEM** function key as many times as required, or alternatively press the **SYSTEM** function key once, then the **PARAM** section select soft key. (See “1. Displaying Parameters.”)
- (4) Display the page containing the parameter you want to set, and position the cursor on the parameter. (See “1. Displaying Parameters.”)
- (5) Enter data, then press the **[INPUT]** soft key. The parameter indicated by the cursor is set to the entered data.

[Example] 12000 [INPUT]

PARAMETER (FEEDRATE)				O0001 N00010		
1401	RDR			JZR	RPD	
	0	0	0	0	0	0
1402			JRV			
	0	0	0	0	0	0
1410	DRY RUN FEEDRATE				12000	
1412					0	
1420	RAPID FEEDRATE		X		15000	
			Y		15000	
			Z		15000	
>						
MDI STOP *** ** ALM 10:03:10						
[NO. SRH] [ON:1] [OFF:0] [+INPUT] [INPUT]						

Cursor

Data can be entered continuously for parameters, starting at the selected parameter, by separating each data item with a semicolon (;).

[Example]

Entering 10;20;30;40 and pressing the INPUT key assigns values 10, 20, 30, and 40 to parameters in order starting at the parameter indicated by the cursor.

- (6) Repeat steps (4) and (5) as required.
- (7) If parameter setting is complete, set "PARAMETER WRITE=" to 0 on the setting screen to disable further parameter setting.
- (8) Reset the NC to release the alarm condition (P/S100).

If an alarm condition (P/S000 PLEASE TURN OFF POWER) occurs in the NC, turn it off before continuing operation.

Note

The bits left blank in 4. DESCRIPTION OF PARAMETERS and the parameter numbers that appear on the CRT screen but are not found in the parameter list are reserved for future expansion. They must always be 0.

3

INPUTTING AND OUTPUTTING PARAMETERS THROUGH THE READER/PUNCHER INTERFACE



This section explains the parameter input/output procedures for input/output devices connected to the reader/puncher interface.

The following description assumes the input/output devices are ready for input/output. It also assumes parameters peculiar to the input/output devices, such as the baud rate and the number of stop bits, have been set in advance.

3.1 OUTPUTTING PARAMETERS THROUGH THE READER/PUNCHER INTERFACE

- (1) Select the EDIT mode.
- (2) To select the parameter screen, press the SYSTEM function key as many times as required, or alternatively press the SYSTEM function key once, then the PARAM section select soft key.
- (3) Press the **[OPRT]** soft key to display operation select soft keys, then press the forward menu key located at the right-hand side of the soft keys to display another set of operation select keys including PUNCH.

PARAMETER (FEEDRATE) O0001 N00010

1401	RDR				JZR	RPD
	0	0	0	0	0	0
1402			JRV			
	0	0	0	0	0	0
1410	DRY RUN FEEDRATE				12000	
1412					0	
1420	RAPID FEEDRATE		X		15000	
			Y		15000	
			Z		15000	

>
MDI STOP *** ** ALM 10:03:10
[NO. SRH] [ON:1] [OFF:0] [+INPUT] [INPUT]

Return menu key Soft keys Continuous menu key

Cursor
State display
Soft key display (operation select)

- (4) Pressing the **[PUNCH]** soft key changes the soft key display as shown below:

>
EDIT STOP *** ** ** 10:35:03
[] [] [] [CANCEL] [EXEC]

- (5) Press the **[EXEC]** soft key to start parameter output. When parameters are being output, "OUTPUT" blinks in the state display field on the lower part of the screen.

>
EDIT STOP *** ** ** 10:35:04 OUTPUT
[] [] [] [CANCEL] [EXEC]

← OUTPUT blinking

- (6) When parameter output terminates, "OUTPUT" stops blinking. Press the RESET key to interrupt parameter output.

3.2 INPUTTING PARAMETERS THROUGH THE READER/PUNCHER INTERFACE

- (1) Place the NC in the emergency stop state.
- (2) Enable parameter writing.
 1. To display the setting screen, press the SETTING function key as many times as required, or alternatively press the SETTING function key once, then the SETTING section select soft key. The first page of the setting screen appears.
 2. Position the cursor on “PARAMETER WRITE” using the cursor move keys.
 3. Press the **[(OPRT)]** soft key to display operation select soft keys.
 4. To set “PARAMETER WRITE=” to 1, press the ON:1 soft key, or alternatively enter 1, then press the **[INPUT]** soft key. From now on, parameters can be set. At the same time an alarm condition (P/S100 PARAMETER WRITE ENABLE) occurs in the NC.
- (3) To select the parameter screen, press the SYSTEM function key as many times as required, or alternatively press the SYSTEM key once, then **[PARAM]** soft key.
- (4) Press the **[(OPRT)]** soft key to display operation select keys, then press the forward menu key located at the right-hand side of the soft keys to display another set of operation select soft keys including **[READ]**.

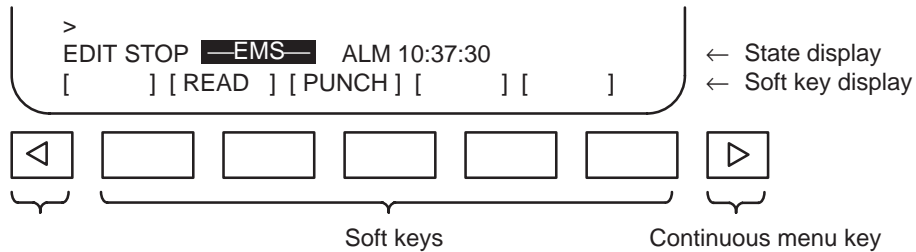

- (5) Pressing the **[READ]** soft key changes the soft key display as shown below:



- (6) Press the **[EXEC]** soft key to start inputting parameters from the input/output device. When parameters are being input, “INPUT” blinks in the state display field on the lower part of the screen.

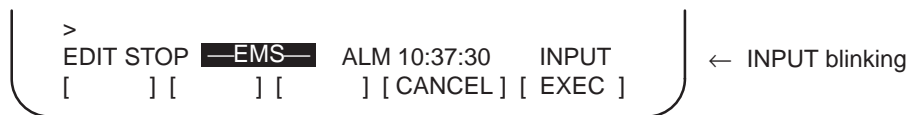

- (7) When parameter input terminates, “INPUT” stops blinking. Press the RESET key to interrupt parameter input.
- (8) When parameter read terminates, “INPUT” stops blinking, and an alarm condition (P/S000) occurs in the NC. Turn it off before continuing operation.

4 DESCRIPTION OF PARAMETERS

Parameters are classified by data type as follows:

Table 4 Data Types and Valid Data Ranges of Parameters

Data type	Valid data range	Remarks
Bit	0 or 1	
Bit axis		
Byte	0 – ± 127	In some parameters, signs are ignored.
Byte axis	0 – 255	
Word	0 – ± 32767	In some parameters, signs are ignored.
Word axis	0 – 65535	
2-word	0 – ± 99999999	
2-word axis		

Notes

- 1 For the bit type and bit axis type parameters, a single data number is assigned to 8 bits. Each bit has a different meaning.
- 2 The axis type allows data to be set separately for each control axis.
- 3 The valid data range for each data type indicates a general range. The range varies according to the parameters. For the valid data range of a specific parameter, see the explanation of the parameter.

(1) Notation of bit type and bit axis type parameters

[Example]

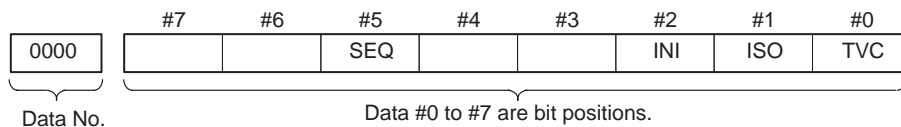

(2) Notation of parameters other than bit type and bit axis type

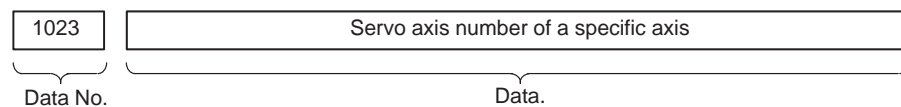

Notes

- 1 The systems may be classified as follows:
 T series : 16/18/160/180-TC
 M series : 16/18/160/180-MC
 2-path control :with an option of 2-path control
- 2 Parameters having different meanings between the T series and M series and parameters that are valid only for the T or M series are indicated in two levels as shown below. Parameters left blank are unavailable.

Example1

Parameter 5010 has different meanings for the T series and M series.

5010	Tool nose radius compensation ...	T series
	Tool compensation C ...	M series

Example2

DPI is a parameter common to the M and T series, but GSB and GSC are parameters valid only for the T series.

3401	#7 GSC	#6 GSB	#0 DPI	T series
			DPI	M series

Example3

The following parameter is provided only for the M series.

1450		T series
	F1 digit feed ...	M series

4.1 PARAMETERS OF SETTING

	#7	#6	#5	#4	#3	#2	#1	#0
0000			SEQ			INI	ISO	TVC

Setting entry is acceptable.

[Data type] Bit

- TVC** TV check
0 : Not performed
1 : Performed
- ISO** Code used for data output
0 : EIA code
1 : ISO code
- INI** Unit of input
0 : In mm
1 : In inches
- SEQ** Automatic insertion of sequence numbers
0: Not performed
1: Performed

Note

When a program is prepared by using MDI keys in the part program storage and edit mode, a sequence number can automatically be assigned to each block in set increments. Set the increment to parameter 3216.

	#7	#6	#5	#4	#3	#2	#1	#0
0001							FCV	

Setting entry is acceptable.

[Data type] Bit

- FCV** Tape format
0: Series 16 standard format
1: Series 15 format

Notes

Programs created in the Series 15 tape format can be used for operation on the following functions:

- 1 Subprogram call M98
- 2 Thread cutting with equal leads G32 (T series)
- 3 Canned cycle G90, G92, G94 (T series)
- 4 Multiple repetitive canned cycle G71 to G76 (T series)
- 5 Drilling canned cycle G73, G74, G76, G80 to G89 (M series)
- 6 Cutter compensation C (M series)

When the tape format used in the Series 15 is used for this CNC, some limits may add. Refer to the Series 16/18/160/180-MODEL C OPERATOR'S MANUAL (B-62754EN (16/18/160/180-TC), or B-62764EN (16/18/160/180-MC)).

	#7	#6	#5	#4	#3	#2	#1	#0
0002								RDG
	SJZ							RDG

Setting entry is acceptable.

[Data type] Bit

RDG Remote diagnose
 0 : Not performed
 1 : Performed

Note

Set this bit to 0 when the remote diagnosis functions is not used. When this bit is set to 1, never modify the parameters related to remote diagnosis (parameter Nos. 0201 to 0223).

SJZ Manual reference position si performed as follows:
 0 : When no reference position has been set, reference position return is performed using deceleration dogs. When a reference position is already set, reference position return is performed using rapid traverse and deceleration dogs are ignored.
 1 : Reference position return is performed using deceleration dogs at all times.

Note

SJZ is enabled when bit 3 (HJZ) of parameter No. 1005 is set to 1. When a reference position is set without a dog, (i.e. when bit 1 (DLZ) of parameter No. 1002 is set to 1 or bit 1 (DLZx) of parameter No. 1005 is set to 1) reference position return after reference position setting is performed using rapid traverse at all times, regardless of the setting of SJZ.

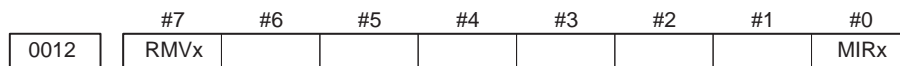

Setting entry is acceptable.

[Data type] Bit axis

MIRx Mirror image for each axis

0 : Mirror image is off.

1 : Mirror image is on.

RMVx Releasing the assignment of the control axis for each axis

0 : Not released

1 : Released

Note

RMVx is valid when RMBx in parameter 1005 is 1.



Setting entry is acceptable.

[Data type] Byte

[Valid data range] 0 to 35

This CNC provides the following interfaces for data transfer to and from the host computer and external input/output devices:

- Input/output device interface (RS-232-C serial port)
- Remote buffer interface (RS-232-C/RS-422)
- DNC1/DNC2 interface

In addition, data can be transferred to and from the Power Mate via the FANUC I/O Link.

This parameter is used to select the interface used to transfer data to and from an input/output device.

Notes

- 1 The input/output device used can be selected also on the setting screen. Using the setting screen is a more common method for selecting the device.
- 2 The specified data, such as a baud rate and the number of stop bits, of an input/output device connected to a specific channel must be set in parameters for that channel in advance.
I/O CHANNEL=0 and I/O CHANNEL=1 both refer to channel 1. For each, parameters to set the baud rate, the number of stop bits, and other data are provided separately.

Setting	Description							
0, 1	RS-232-C serial port (connector JD5A on the main CPU board)							
2	RS-232-C serial port (connector JD5B on the main CPU board)							
3	Remote buffer interface (connector JD5C (RS-232-C interface) or connector JD6A (RS-422 interface) on option 1 board)							
5	Data server board							
10	DNC1/DNC2 interface, OSI-Ethernet							
11	DNC1 interface #2							
20 21 22 34 35	<table border="0"> <tr> <td>Group 0</td> <td rowspan="6">} Data is transferred between the CNC and Power Mate in group n (n: 0 to 15) via the FANUC I/O Link.</td> </tr> <tr> <td>Group 1</td> </tr> <tr> <td>Group 2</td> </tr> <tr> <td> </td> </tr> <tr> <td>Group 14</td> </tr> <tr> <td>Group 15</td> </tr> </table>	Group 0	} Data is transferred between the CNC and Power Mate in group n (n: 0 to 15) via the FANUC I/O Link.	Group 1	Group 2		Group 14	Group 15
Group 0	} Data is transferred between the CNC and Power Mate in group n (n: 0 to 15) via the FANUC I/O Link.							
Group 1								
Group 2								
Group 14								
Group 15								

Notes

- 1 An input/output device can also be selected using the setting screen. Usually the setting screen is used.
- 2 Specifications (such as the baud rate and number of stop bits) of input/output devices to be connected need to be set in the corresponding parameters for each interface beforehand. (See Section 4.2) I/O channel = 0 and I/O channel = 1 represent input/output devices connected to RS-232-C serial port 1. However, separate parameters for the baud rate, stop bits, and other specifications are provided for each channel.

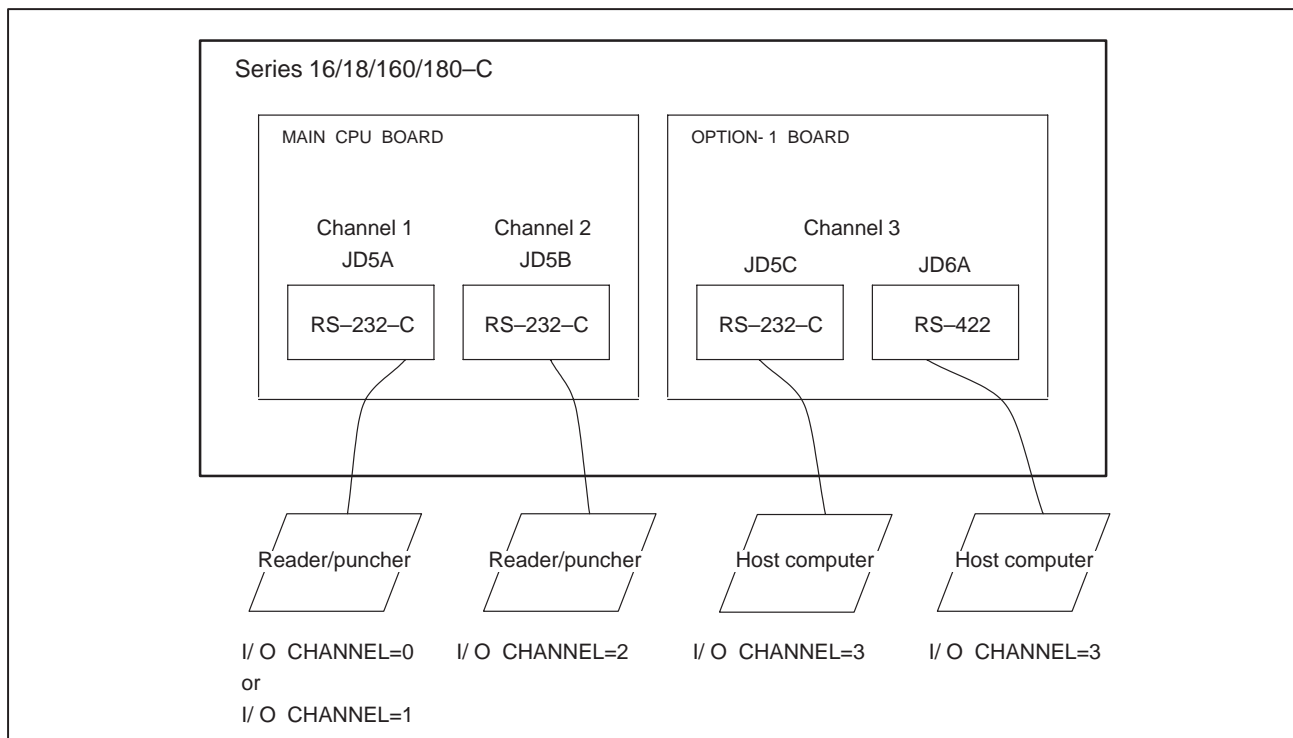

Fig.4.1 I/O Unit Selection

4.2 PARAMETERS OF READER/PUNCHER INTERFACE, REMOTE BUFFER, DNC1, DNC2, AND M-NET INTERFACE

This CNC has three channels of input/output device interfaces. The input/output device to be used is specified by setting the channel connected to that device in setting parameter I/O CHANNEL.

The specified data, such as a baud rate and the number of stop bits, of an input/output device connected to a specific channel must be set in parameters for that channel in advance.

For channel 1, two combinations of parameters to specify the input/output device data are provided.

The following shows the interrelation between the input/output device interface parameters for the channels.

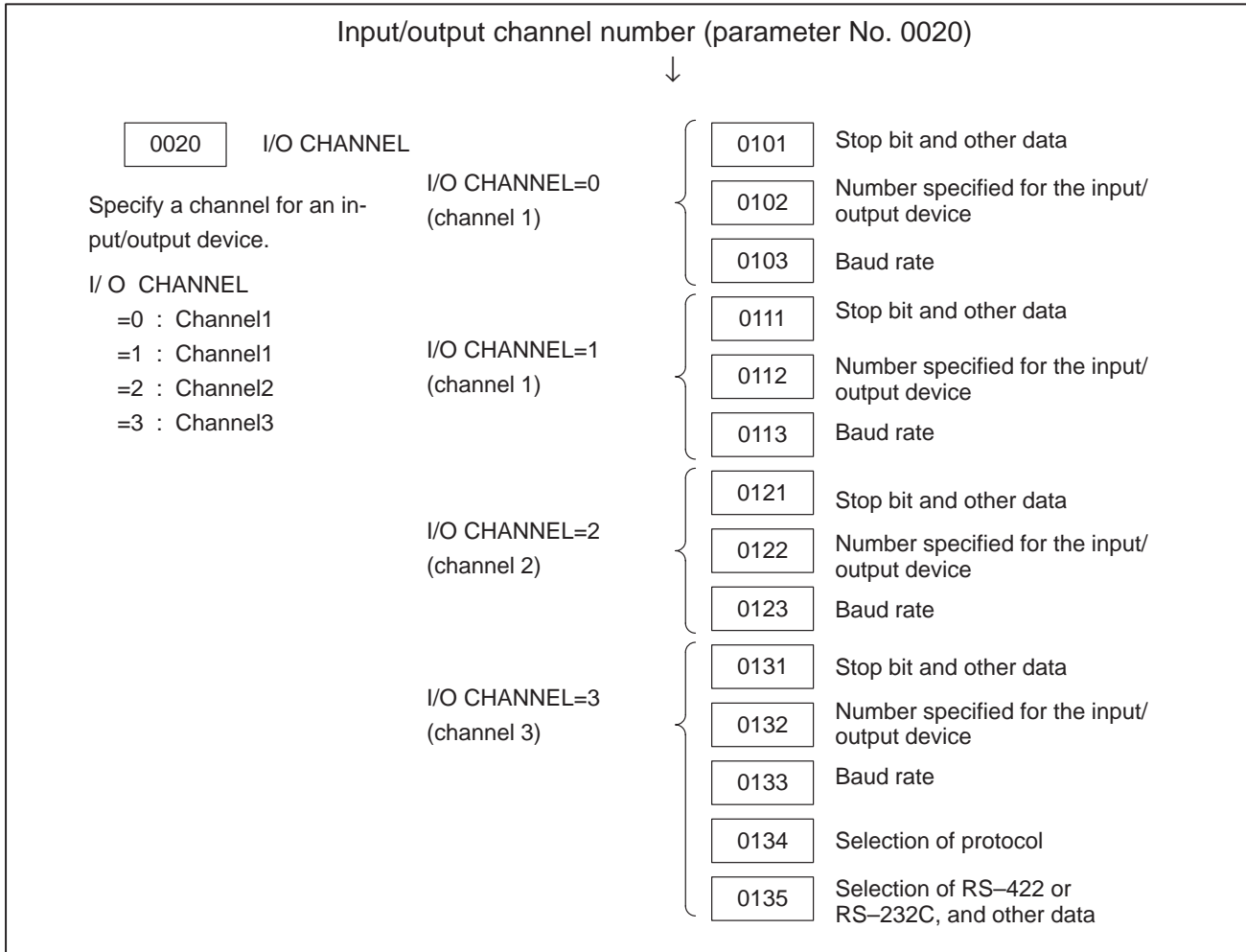

Fig.4.2 I/O Device Interface Settings

(1) Parameters common to all channels

	#7	#6	#5	#4	#3	#2	#1	#0
0100	ENS	IOP	ND3		NCR		CTV	

Setting entry is acceptable.

[Data type] Bit

CTV: Character counting for TV check in the comment section of a program.

- 0 : Performed
- 1 : Not performed

NCR Output of the end of block (EOB) in ISO code

- 0 : LF, CR, CR are output.
- 1 : Only LF is output.

ND3 In DNC operation, a program is:

- 0 : Read block by block. (A DC3 code is output for each block.)
- 1 : Read continuously until the buffer becomes full. (A DC3 code is output when the buffer becomes full.)

Note

In general, reading is performed more efficiently when ND3 = 1. This specification reduces the number of buffering interruptions caused by reading of a series of blocks specifying short movements. This in turn reduces the effective cycle time.

IOP Specifies how to stop NC program input/output operations.

- 0 : An NC reset can stop NC program input/output operations.
- 1 : Only the **[STOP]** soft key can stop NC program input/output operations. (An NC reset cannot stop NC program input/output operations.)

ENS Action taken when a NULL code is found during read of EIA code

- 0 : An alarm is generated.
- 1 : The NULL code is ignored.

(2) Parameters for channel 1 (I/O CHANNEL=0)

	#7	#6	#5	#4	#3	#2	#1	#0
0101	NFD				ASI			SB2

[Data type] Bit type

SB2 The number of stop bits

- 0 : 1
- 1 : 2

ASI Code used at data input

- 0 : EIA or ISO code (automatically distinguished)
- 1 : ASCII code

NFD Feed before and after the data at data output

- 0 : Output
- 1 : Not output

Note

When input/output devices other than the FANUC PPR are used, set NFD to 1.

0102

Number specified for the input/output device (when the I/O CHANNEL is set to 0)

[Data type] Byte

Set the number specified for the input/output device used when the I/O CHANNEL is set to 0, with one of the set values listed in Table 4.2 (a).

Table 4.2 (a) Set value and Input/Output Device

Set value	Input/output device
0	RS-232-C (Used control codes DC1 to DC4)
1	FANUC CASSETTE ADAPTOR 1 (FANUC CASSETTE B1/ B2)
2	FANUC CASSETTE ADAPTOR 3 (FANUC CASSETTE F1)
3	FANUC PROGRAM FILE Mate, FANUC FA Card Adaptor FANUC FLOPPY CASSETTE ADAPTOR, FANUC Handy File FANUC SYSTEM P-MODEL H
4	RS-232-C (Not used control codes DC1 to DC4)
5	Portable tape reader
6	FANUC PPR FANUC SYSTEM P-MODEL G, FANUC SYSTEM P-MODEL H

0103

Baud rate (when the I/O CHANNEL is set to 0)

[Data type] Byte

Set baud rate of the input/output device used when the I/O CHANNEL is set to 0, with a set value in Table 4.2 (b).

Table 4.2 (b)

Set value	Baud rate (bps)	Set value	Baud rate (bps)
1	50	7	600
2	100	8	1200
3	110	9	2400
4	150	10	4800
5	200	11	9600
6	300	12	19200

(3) Parameters for channel 1 (I/O CHANNEL=1)

	#7	#6	#5	#4	#3	#2	#1	#0
0111	NFD				ASI			SB2

[Data type] Bit

These parameters are used when I/O CHANNEL is set to 1. The meanings of the bits are the same as for parameter 0101.

0112

Number specified for the input/output device (when I/O CHANNEL is set to 1)

[Data type] Byte

Set the number specified for the input/output device used when the I/O CHANNEL is set to 1, with one of the set values listed in Table 4.2 (a).

0113

Baud rate (when I/O CHANNEL is set to 1)

[Data type] Byte

Set the baud rate of the input/output device used when I/O CHANNEL is set to 1, with a value in Table 4.2 (b).

(4) Parameters for channel 2 (I/O CHANNEL=2)

	#7	#6	#5	#4	#3	#2	#1	#0
0121	NFD				ASI			SB2

[Data type] Bit

These parameters are used when I/O CHANNEL is set to 2. The meanings of the bits are the same as for parameter 0101.

0122

Number specified for the input/output device (when I/O CHANNEL is set to 2)

[Data type] Byte

Set the number specified for the input/output device used when I/O CHANNEL is set to 2, with a value in Table 4.2 (a).

0123

Baud rate (when the I/O CHANNEL is set to 2)

[Data type] Byte

Set the baud rate of the input/output device used when I/O CHANNEL is set to 2, with a value in Table 4.2 (b).

(5) Parameters for channel 3 (I/O CHANNEL=3)

	#7	#6	#5	#4	#3	#2	#1	#0
0131	NFD				ASI			SB2

Note

When this parameter is set, the power must be turned off before operation is continued.

[Data type] Bit

These parameters are used when I/O CHANNEL is set to 3. The meanings of the bits are the same as for parameter 0101.

0132	Number specified for the input/output device (when I/O CHANNEL is set to 3)
------	-----------------------------------------------------------------------------

Note
When this parameter is set, the power must be turned off before operation is continued.

[Data type] Byte

Set the number specified for the input/output device used when I/O CHANNEL is set to 3, with a number in Table 4.2 (a).

0133	Baud rate (when the I/O CHANNEL is set to 3)
------	----------------------------------------------

Note
When this parameter is set, the power must be turned off before operation is continued.

[Data type] Byte

Set the baud rate of the input/output device used when the I/O CHANNEL is set to 3 according to the table 4.2 (c).

Note
Valid data range: 1 to 15 (up to a baud rate of 86400 bps) for the RS-422 interface or 1 to 12 (up to a baud rate of 19200 bps) for the RS-232-C interface.

Table 4.2 (c) Baud Rate Settings

Set value	Baud rate (bps)	Set value	Baud rate (bps)
1	50	9	2400
2	100	10	4800
3	110	11	9600
4	150	12	19200
5	200	13	38400
6	300	14	76800
7	600	14	86400
8	1200		

	#7	#6	#5	#4	#3	#2	#1	#0
0134			CLK	NCD		SYN	PRY	

Note
When this parameter is set, the power must be turned off before operation is continued.

[Data type] Bit

- PRY** Parity bit
0: Not used
1: Used
- SYN** NC reset/alarm in protocol B
0: Not reported to the host
1: Reported to the host with SYN and NAK codes
- NCD** CD (signal quality detection) of the RS-232-C interface
0: Checked
1: Not checked
- CLK** Baud rate clock when the RS-422 interface is used
0: Internal clock
1: External clock

Note

When the RS-232-C interface is used, set this bit to 0.

	#7	#6	#5	#4	#3	#2	#1	#0
0135	RMS				R42	PRA	ETX	ASC

Note

When this parameter is set, the power must be turned off before operation is continued.

[Data type] Bit

- ASC** Communication code except NC data
0: ISO code
1: ASCII code
- ETX** End code for protocol A or extended protocol A
0: CR code in ASCII/ISO
1: ETX code in ASCII/ISO

Note

Use of ASCII/ISO is specified by ASC.

- PRA** Communication protocol
0: Protocol B
1: Protocol A
- R42** Interface
0: RS-232-C interface
1: RS-422 interface
- RMS** State of remote/tape operation when protocol A is used
0: Always 0 is returned.
1: Contents of the change request of the remote/tape operation in the SET command from the host is returned.

	#7	#6	#5	#4	#3	#2	#1	#0
0140			BCC					

Note

When this parameter is set, the power must be turned off before operation is continued.

[Data type] Bit

BCC The BCC value (block check characters) for the DNC2 interface is:
 0: Checked.
 1: Not checked.

0141	System for connection between the CNC and host (DNC1 interface)
------	-----------------------------------------------------------------

[Data type] Byte

[Valid data range] 1 or 2

This parameter specifies the system for connection (DNC1 interface) between the CNC and host.

Set value

1 : Point-to-point connection

2 : Multipoint connection

Note

When this parameter is set, the power must be turned off before operation is continued.

0142	Station address of the CNC (DNC1 interface)
------	---------------------------------------------

[Data type] Byte

[Valid data range] 2 to 52

This parameter specifies the station address of the CNC when the CNC is connected via the DNC1 interface using multipoint connection.

Note

When this parameter is set, the power must be turned off before operation is continued.

0143	Time limit specified for the timer monitoring a response (DNC2 interface)
------	---------------------------------------------------------------------------

Note

When this parameter is set, the power must be turned off before operation is continued.

[Data type] Byte

[Unit of data] Seconds

[Valid data range] 1 to 60 (The standard setting is 3.)

0144

Time limit specified for the timer monitoring the EOT signal (DNC2 interface)

Note

When this parameter is set, the power must be turned off before operation is continued.

[Data type] Byte

[Unit of data] Seconds

[Valid data range] 1 to 60 (The standard setting is 5.)

0145

Time required for switching RECV and SEND (DNC2 interface)

Note

When this parameter is set, the power must be turned off before operation is continued.

[Data type] Byte

[Unit of data] Seconds

[Valid data range] 1 to 60 (The standard setting is 1.)

0146

Number of times the system retries holding communication (DNC2 interface)

Note

When this parameter is set, the power must be turned off before operation is continued.

[Data type] Byte

[Unit of data] Seconds

[Valid data range] 1 to 10 (The standard setting is 3.)

Set the maximum number of times the system retries holding communication with the remote device if the remote device uses an invalid protocol in the data-link layer or the remote device does not respond to the request.

0147

Number of times the system sends the message in response to the NAK signal (DNC2 interface)

Note

When this parameter is set, the power must be turned off before operation is continued.

[Data type] Byte

[Unit of data] Number of times

[Valid data range] 1 to 10 (The standard setting is 2.)

Set the maximum number of times the system retries sending the message in response to the NAK signal.

0148

Number of characters in overrun (DNC2) interface)

Note

When this parameter is set, the power must be turned off before operation is continued.

[Data type] Byte

[Valid data range] 10 to 225 (The standard setting is 10.)

Set the number of characters the system can receive after transmission is stopped (CS off).

0149

Number of characters in the data section of the communication packet (DNC2 interface)

Note

When this parameter is set, the power must be turned off before operation is continued.

[Data type] Word

[Valid range] 80 to 256

The standard setting is 256. If the specified value is out of range, a value of 80 or 256 is used.

This parameter determines the maximum length of the packet used in transmission over the DNC2 interface. Including the two characters at the start of the packet, the four characters used for a command, and the three characters at the end, the maximum number of characters in the packet is nine plus the number specified in parameter No. 0149.

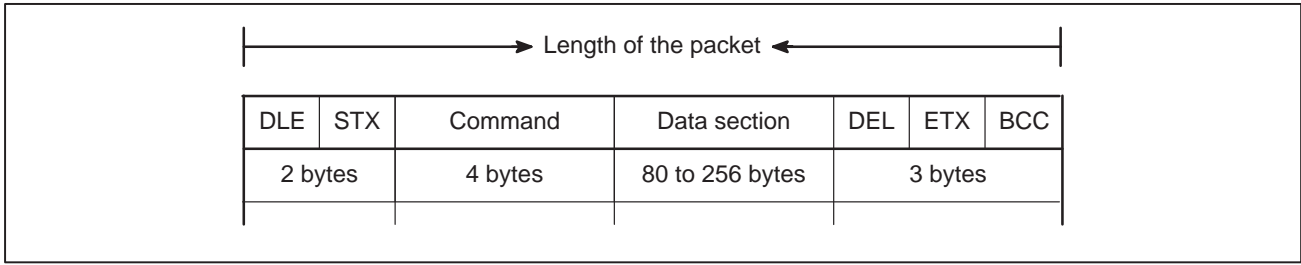

	#7	#6	#5	#4	#3	#2	#1	#0
0161	SRS		PEO	SRP		SRL		

Note
When this parameter is set, the power must be turned off before operation is continued.

[Data type] Bit

- SRL Number of characters used in the serial interface
0: Seven bits
1: Eight bits
- SRP Vertical parity in the serial interface
0: Vertical parity is not checked.
1: Vertical parity is checked.
- PEO Either odd or even parity is used for vertical parity in the serial interface
0: Odd parity is used.
1: Even parity is used.

Note
This bit is effective when bit SRP is set to 1.

- SRS Stop bit in the serial interface
0: One stop bit is used.
1: Two stop bits are used.

Note
Set this parameter (No. 0161) when the M-NET interface is used.

0171	Length of DI data in bytes in M-NET
------	-------------------------------------

Note
When this parameter is set, the power must be turned off before operation is continued.

[Data type] Byte

[Valid range] 1 to 32

Specify the length of DI data in bytes (number of byte of data actually transferred from the PLC unit to the CNC unit) in the serial interface.

0172

Length of DO data in bytes in M-NET

Note

When this parameter is set, the power must be turned off before operation is continued.

[Data type] Byte

[Valid range] 1 to 32

Specify the length of DO data in bytes (number of bytes of data actually transferred from the CNC unit to the PLC unit) in the serial interface.

Note

When a self-loop test is performed, specify the same value in parameters No. 0171 and No. 0172.

0173

Station address in M-NET

Note

When this parameter is set, the power must be turned off before operation is continued.

[Data type] Byte

[Valid range] 1 to 15

Specify a station address in the serial interface.

0174

Baud rate in M-NET

Note

When this parameter is set, the power must be turned off before operation is continued.

[Data type] Byte

[Valid range] 0 to 6

Specify a baud rate for the serial interface. The standard setting is 3.

Setting	Baud rate (bps)			
1	2	4	0	0
2	4	8	0	0
3	9	6	0	0
4	1	9	2	0
5	3	8	4	0
6	5	7	6	0
7	7	6	8	0

0175

Time required for connecting two stations in M-NET

Note

When this parameter is set, the power must be turned off before operation is continued.

[Data type] Word

[Unit of data] ms

[Valid range] 1 to 32767

Specify a time limit from when the connection sequence is completed for the self-station to when the normal transfer sequence starts in the serial interface. The standard setting is 10000.

0176

Time required for polling in M-NET

Note

When this parameter is set, the power must be turned off before operation is continued.

[Data type] Word

[Unit of data] ms

[Valid data range] 1 to 32767

Specify a time limit for polling in the normal sequence at the self-station in the serial interface. The standard setting is 500.

0177

Time required from SAI to BCC in M-NET

Note

When this parameter is set, the power must be turned off before operation is continued.

[Data type] Word

[Unit of data] ms

[Valid data range] 1 to 32767

Specify a time limit from when the SAI signal starts to be transferred to when the BCC signal has been sent. The standard setting is 50.

0178	Time between a reception and the next transmission in M-NET
------	-------------------------------------------------------------

Note
When this parameter is set, the power must be turned off before operation is continued.

[Data type] Word

[Unit of data] ms

[Valid data range] 1 to 32767

Specify the time from when data has been received to when the next data starts to be transmitted. The standard setting is 1.

(6) Parameter for remote diagnose

	#7	#6	#5	#4	#3	#2	#1	#0
0201						NCR	ASC	SB2

[Data type]

SB2 Number of stop bits
0 : 1 bit
1 : 2 bit

ASC Data output code
0 : ISO Code
1 : ASCII Code

NCR EOB (End of Block) is output as
0 : "LF" "CR" "CR"
1 : "LF"

0203	Band rate (For remote diagnosis)
------	----------------------------------

[Data type] Byte

Set value	Baud rate
1	50
2	100
3	110
4	150
5	200
6	300

Set value	Baud rate
7	600
8	1200
9	2400
10	4800
11	9600

0204	Channel used for remote diagnosis
------	-----------------------------------

[Data type] Byte

[Valid data range] 0, 1, 2
 Interface used for remote diagnosis
 0, 1: RS-232-C Serial Port 1 (Channel 1)
 2 : RS-232-C Serial Port 2 (Channel 2)

0206	Device ID number for remote diagnosis
------	---------------------------------------

[Data type] Byte

[Valid data range] 0 to 20

This parameter sets a device identifier (ID) for identifying each CNC with which the host computer is to communicate.

With the remote diagnosis function, multiple CNCs can be diagnosed via a single telephone line by using wireless adapters. Besides wireless adapter device numbers, a device ID can be assigned to each CNC to check that the correct CNC to be diagnosed is selected.

When wireless adapters are used

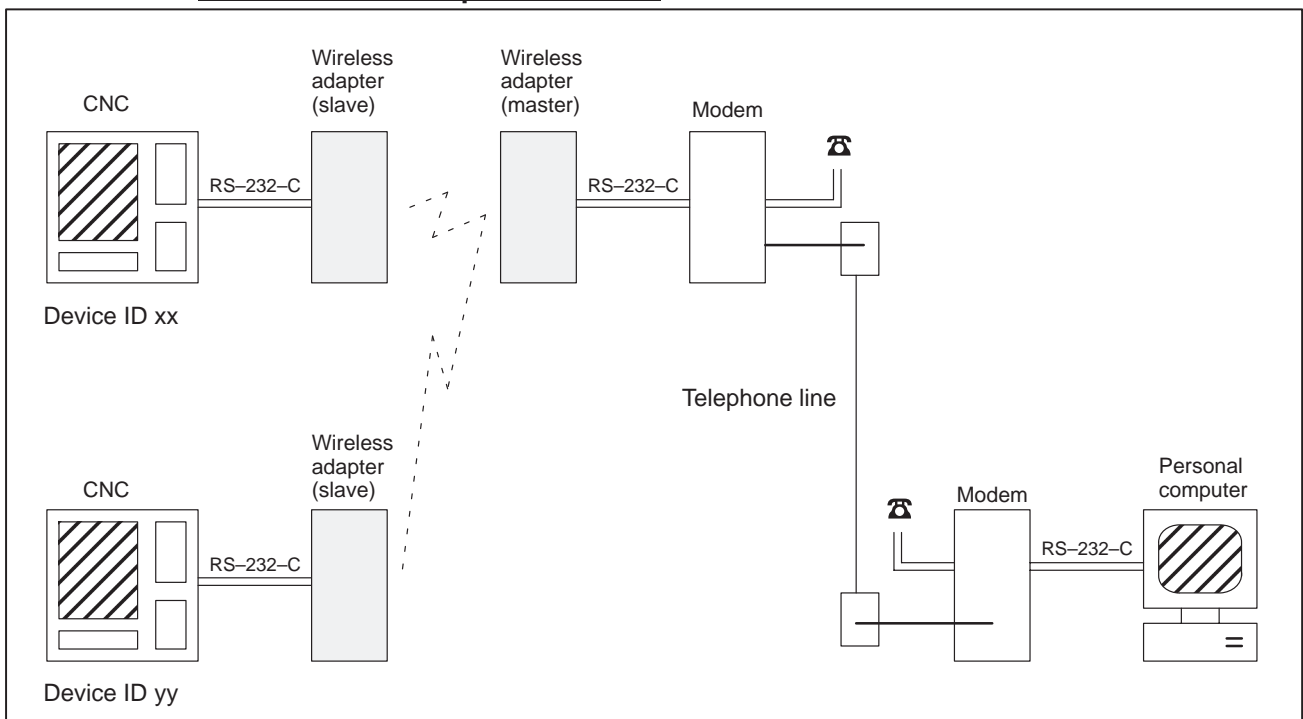

When wireless adapters are not used

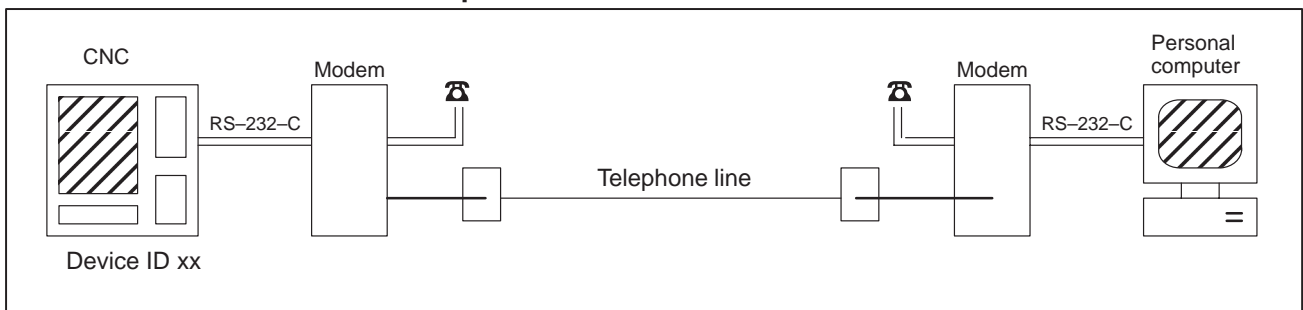

0211	Password 1 for remote diagnose
0212	Password 2 for remote diagnose
0213	Password 3 for remote diagnose

[Valid data range] 1 to 99999999

These parameters set passwords for using the remote diagnosis function. With the remote diagnosis function, three types of passwords are available for protecting data. These passwords help to prevent unauthorized persons from accessing system parameters and machining programs.

Password 1:

Sets a password for all services of the remote diagnosis function. (No remote diagnosis function services are available until this password is entered on the host computer (personal or other)).

Password 2:

Sets a password for part programs. (Program-related operations such as program data input/output and check cannot be performed until this password is entered on the host computer (personal or other)).

Password 3:

Sets a password for parameters. (Parameter-related operations such as parameter data input/output cannot be performed until this password is entered on the host computer (personal or other)).

Note

Once a value other than 0 is set as a password, the password cannot be modified until the same value is set in the corresponding keyword parameter (parameter Nos. 221 to 223.) When a value other than 0 is set as a password, the parameter screen does not display the value of the password; only blanks are displayed. Care must be taken in setting a password.

0221	Key word 1 for remote diagnosis
0222	Key word 2 for remote diagnosis
0223	Key word 3 for remote diagnosis

[Valid data range] 1 to 99999999

These parameters set the keywords for passwords used with the remote diagnosis function.

Keyword 1: Keyword for password 1 (parameter No. 211)

Keyword 2: Keyword for password 2 (parameter No. 212)

Keyword 3: Keyword for password 3 (parameter No. 213)

When a value other than 0 is specified as a password (parameter Nos. 211 to 213), the password cannot be modified until the same value is set in the corresponding keyword parameter.

Notes

- 1 Upon power-up, the keyword parameters are set to 0.
- 2 The parameter screen does not display any set keyword values; only blanks are displayed.

(7) Parameter of DNC interface #2

	#7	#6	#5	#4	#3	#2	#1	#0
0231	NFD				ASI			SB2

Note

When this parameter is set, the power must be turned off before operation is continued.

[Data type]

SB2 Number of stop bits

- 0: 1 bit
- 1: 2 bits

ASI Data input code

- 0: IEA or ISO (automatic recognition)
- 1: ASCII Code

NFD When data is out, feed holes are

- 0: Output before and after data section
- 1: Not output

0233	Baud rate (DNC1 interface)
------	----------------------------

Note

When this parameter is set, the power must be turned off before operation is continued.

[Data type] Byte

[Valid data range] 1 to 15

Baud rate

Set value	Baud rate (bps)
1	50 bps
2	100
3	110
4	150
5	200

Set value	Baud rate (bps)
6	300 bps
7	600
8	1200
9	2400
10	4800

Set value	Baud rate (bps)
11	9600 bps
12	19200
13	38400
14	76800
15	86400

0241	Mode of connection between the host and CNC (DNC1 interface)
------	--------------------------------------------------------------

Note
When this parameter is set, the power must be turned off before operation is continued.

[Data type] Byte

[Valid data range] 1 to 2

This parameter sets the mode of connection between the host and CNC.

Setting	Mode
1	Point-to-point mode
2	Multipoint mode

0242	CNC station address (DNC 1 interface)
------	---------------------------------------

Note
When this parameter is set, the power must be turned off before operation is continued.

[Data type] Byte

[Valid data range] 2 to 52

This parameter sets a CNC station address when the CNC is to be connected in the multipoint mode.

(8) Parameters related to the data server

0900	#7	#6	#5	#4	#3	#2	#1	#0
								DSV

[Data type] Bit

[DSV The data server function is]

- 0: Enabled
- 1: Disabled

0911	Alternate MDI character
------	-------------------------

[Data type] Word

[Set value] ASCII code (decimal)

0192	Character not provided in MDI keys
------	------------------------------------

[Data type] Word

[Set value] ASCII code (decimal)

When specifying a character which is not provided as a MDI keys for HOST DIRECTORY of DATA SERVER SETTING-1, use these parameters to assign an alternative key to that character.

Examples

If ODSERVERONCPROG is specified for HOST DIRECTORY, you cannot enter “O” with the MDI keys. To use “@” as an alternative character, set 64 (ASCII code for @) in parameter No. 0911 and 92 (ASCII code for \) in parameter No. 0912.

When

“DSERVER@NCPROG”

is specified for HOST DIRECTORY, the data server converts it to “ODSERVERONCPROG”.

Note

When both parameters No. 0911 and 0912 are set to 0, the data server assumes the following setting:

No. 0911 = 32 (blank)

No. 0912 = 92 (\)

4.3 PARAMETERS OF AXIS CONTROL/ INCREMENT SYSTEM

	#7	#6	#5	#4	#3	#2	#1	#0
1001								INM

Note

When this parameter is set, the power must be turned off before operation is continued.

[Data type] Bit

INM Least command increment on the linear axis
 0 : In mm (metric system machine)
 1 : In inches (inch system machine)

	#7	#6	#5	#4	#3	#2	#1	#0
1002				XIK		SFD	DLZ	JAX
				XIK	AZR	SFD	DLZ	JAX

[Data type] Bit

JAX Number of axes controlled simultaneously in manual continuous feed, manual rapid traverse and manual reference position return
 0 : 1 axis
 1 : 3 axes

DLZ Function setting the reference position without dog
 0 : Disabled
 1 : Enabled

Note

This function can be specified for each axis by DLZx, bit 1 of parameter No. 1005.

SFD The function for shifting the reference position is
 0: Not used.
 1: Used.

AZR When no reference position is set, the G28 command causes:
 0: Reference position return using deceleration dogs (as during manual reference position return) to be expected.
 1: P/S alarm No. 090 to be issued.

Note

When reference position return without dogs is specified, (when bit 1 (DLZ) of parameter No. 1002 is set to 1 or bit 1 (DLZx) of parameter No. 1005 is set to 1) the G28 command specified before a reference position is set causes P/S alarm No. 090 to be issued, regardless of the setting of AZR.

- XIK** When LRP, bit 1 of parameter No. 1401, is set to 0, namely, when positioning is performed using non-linear type positioning, if an interlock is applied to the machine along one of axes in positioning,
- 0: The machine stops moving along the axis for which the interlock is applied and continues to move along the other axes.
 - 1: The machine stops moving along all the axes.

	#7	#6	#5	#4	#3	#2	#1	#0
1004	IPR						ISC	
	IPR						ISC	ISA

[Data type] Bit

ISA, ISC The least input increment and least command increment are set.

ISC	ISA	Least input increment and least command increment	Symbol
0	0	0.001 mm, 0.001 deg, or 0.0001 inch	IS-B
0	1	0.01 mm, 0.01 deg, or 0.001 inch	IS-A
1	0	0.0001 mm, 0.0001 deg, or 0.00001 inch	IS-C

Note

IS-A cannot be used at present.

- IPR** Whether the least input increment for each axis is set to a value 10 times as large as the least command increment is specified, in increment systems of IS-B and IS-C.
- 0: The least input increment is not set to a value 10 times as large as the least command increment.
 - 1: The least input increment is set to a value 10 times as large as the least command increment.

If IPR is set to 1, the least input increment is set as follows:

Input increment	Least input increment
IS-B	0.01 mm, 0.01 deg, or 0.0001 inch
IS-C	0.001 mm, 0.001 deg, or 0.00001 inch

Note

For IS-A, the least input increment cannot be set to a value 10 times as large as the least command increment.

	#7	#6	#5	#4	#3	#2	#1	#0
1005	RMBx	MCCx	EDMx	EDPx			DLZx	ZRNx
	RMBx	MCCx	EDMx	EDPx	HJZ		DIZx	ZRNx

[Data type] Bit axis

ZRNx When a command specifying the movement except for G28 is issued in automatic operation (MEM, RMT, or MDI) and when a return to the reference position has not been performed since the power was turned on
 0 : An alarm is generated (P/S alarm 224).
 1 : An alarm is not generated.

DLZx Function for setting the reference position without dogs
 0 : Disabled
 1 : Enabled

Note

When DLZ of parameter No. 1002 is 0, DLZx is enabled.
 When DLZ of parameter No. 1002 is 1, DLZx is disabled, and the function for setting the reference position without dogs is enabled for all axes.

HJZ When a reference position is already set:
 0 : Manual reference position return is performed with deceleration dogs.
 1 : Manual reference position return is performed using rapid traverse without deceleration dogs, or manual reference position return is performed with deceleration dogs, depending on the setting of bit 7 of parameter No. 0002.

Note

When reference position return without dogs is specified, (when bit 1 (DLZ) of parameter No. 1002 is set to 1 or bit (DLZx) of parameter No. 1005 is set to 1) reference position return after a reference position is set is performed using rapid traverse, regardless of the setting of HJZ.

EDPx External deceleration signal in the positive direction for each axis
 0 : Valid only for rapid traverse
 1 : Valid for rapid traverse and cutting feed

EDMx External deceleration signal in the negative direction for each axis
 0 : Valid only for rapid traverse
 1 : Valid for rapid traverse and cutting feed

MCCx When an axis become the removal state using the controlled axis removal signal or setting:
 0: MCC is turned off
 1: MCC is not turned off. (Servo motor excitation is turned off, but the MCC signal of the servo amplifier is not turned off.)

Note

This parameter is used to remove only one axis, for example, when a two-axis or three-axis amplifier is used. When two-axis or three-axis amplifier is used and only one axis is removed, servo alarm No. 401 (V-READY OFF) is usually issued. However, this parameter, when set to 1, prevents servo alarm No. 401 from being issued. Note, however, that disconnecting a servo amplifier from the CNC will cause the servo amplifier to enter the V-READY OFF status. This is a characteristic of all multi-axis amplifiers.

RMBx Releasing the assignment of the control axis for each axis (signal input and setting input)

0 : Invalid

1 : Valid

	#7	#6	#5	#4	#3	#2	#1	#0
1006			ZMlx		DIAx		ROSx	ROTx
			ZMlx				ROSx	ROTx

Note

When this parameter is changed, turn off the power before continuing operation.

[Data type] Bit axis

ROTx, ROSx Setting linear or rotation axis.

ROSx	ROTx	Meaning
0	0	Linear axis (1) Inch/metric conversion is done. (2) All coordinate values are linear axis type. (3) Stored pitch error compensation is linear axis type (Refer to parameter No. 3624)
0	1	Rotation axis (A type) (1) Inch/metric conversion is not done. (2) Machine coordinate values are rounded in 0 to 360°. Absolute coordinate values are rounded or not rounded by parameter No. 1008#0 and #2. (3) Stored pitch error compensation is the rotation type. (Refer to parameter No. 3624) (4) Automatic reference position return (G28, G30) is done in the reference position return direction and the move amount does not exceed one rotation.

ROSx	ROTx	Meaning
1	0	Setting is invalid (unused)
1	1	Rotation axis (B type) (1) Inch/metric conversion, absolute coordinate values and relative coordinate values are not done. (2) Machine coordinate values, absolute coordinate values and relative coordinate values are linear axis type. (Is not rounded in 0 to 360°). (3) Stored pitch error compensation is linear axis type (Refer to parameter No. 3624) (4) Cannot be used with the rotation axis roll over function and the index table indexing function (M series)

DIAx Either a diameter or radius is set to be used for specifying the amount of travel on each axis.

0 : Radius

1 : Diameter

ZMIx The direction of reference position return.

0 : Positive direction

1 : Negative direction

Note

The direction of the initial backlash, which occurs when power is switched on, is opposite to the direction of a reference position return.

	#7	#6	#5	#4	#3	#2	#1	#0
1007					RAAx			

[Data type] Bit axis

RAAx When an absolute command is specified for a rotation axis:

0: The end point coordinates and direction of rotation conform to bit 1 (RABx) of parameter No. 1008.

1: The end point coordinates conform to the absolute value of the value specified in the command. The rotational direction conforms to the sign of the value specified in the command.

Note

This parameter is valid when the rotary axis control function is provided and the rotation axis rollover function is applied (bit 0 (ROAx) of parameter No. 1008 is set to 1).

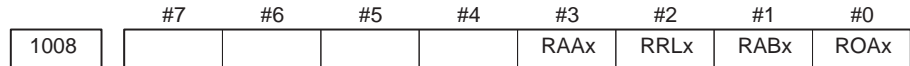
**Note**

When this parameter is set, the power must be turned off before operation is continued.

[Data type] Bit axis

ROAx The roll-over function of a rotation axis is
 0 : Invalid
 1 : Valid

Note

ROAx specifies the function only for a rotation axis (for which ROTx, #0 of parameter No. 1006, is set to 1)

RABx In the absolute commands, the axis rotates in the direction
 0 : In which the distance to the target is shorter.
 1 : Specified by the sign of command value.

Note

RABx is valid only when ROAx is 1.

RRLx Relative coordinates are
 0 : Not rounded by the amount of the shift per one rotation
 1 : Rounded by the amount of the shift per one rotation

Notes

- 1 RRLx is valid only when ROAx is 1.
- 2 Assign the amount of the shift per one rotation in parameter No. 1260.

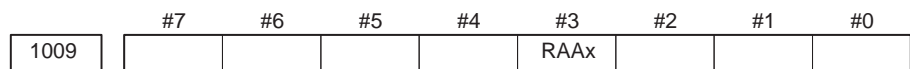

RAAx The rotation direction of a rotation axis and end point coordinates in the absolute command mode:
 0: Agree with the setting of bit 1 (RABx) of parameter No. 1008.
 1: Agree with the absolute value of the specified value for the end point coordinates and the sign of the specified value for the rotation direction.

Note

This parameter is enabled when the rotary axis control function is provided and the rotation axis roll-over function is used (with bit 0 (ROAx) of parameter No. 1008 set to 1).

1010

Number of CNC-controlled axes

Note

When this parameter is set, the power must be turned off before operation is continued.

[Data type] Byte

[Valid data range] 1, 2, 3, ..., the number of controlled axes

Set the maximum number of axes that can be controlled by the CNC.

Examples

Suppose that the first axis is the X axis, and the second and subsequent axes are the Y, Z, A, B, and C axes in that order, and that they are controlled as follows:

X, Y, Z, and A axes: Controlled by the CNC and PMC

B and C axes: Controlled by the PMC

Then set this parameter to 4 (total 4: X, Y, Z, and A)

1020

Name of the axis used for programming for each axis

[Data type] Byte axis

Set the name of the program axis for each control axis, with one of the values listed in the following table:

Axis name	Set value	Axis name	Set value	Axis name	Set value
X	88	U	85	A	65
Y	89	V	86	B	66
Z	90	W	87	C	67

Note

- 1 In the T series, when G code system A is used, neither U, V, nor W can be used as an axis name. Only when G code system B or C is used, U, V, and W can be used as axis names.
- 2 The same axis name cannot be assigned to more than one axis.
- 3 When the secondary auxiliary function is provided, address B cannot be used as an axis name. In the T series, when CCR, #4 of parameter 3405, is set to 1, address A and C may not be used with functions such as chamfering, corner R, or direct drawing dimensions programming.

1022

Setting of each axis in the basic coordinate system

Note

When this parameter is set, power must be turned off before operation is continued.

[Data type] Byte axis

To determine the following planes used for circular interpolation, cutter compensation C (for the M series), tool nose radius compensation (for the T series), etc., each control axis is set to one of the basic three axes X, Y, and Z, or an axis parallel to the X, Y, or Z axis.

G17: Plane Xp–Yp

G18: Plane Zp–Xp

G19: Plane Yp–Zp

Only one axis can be set for each of the three basic axes X, Y, and Z, but two or more parallel axes can be set.

Set value	Meaning
0	Neither the basic three axes nor a parallel axis
1	X axis of the basic three axes
2	Y axis of the basic three axes
3	Z axis of the basic three axes
5	Axis parallel to the X axis
6	Axis parallel to the Y axis
7	Axis parallel to the Z axis

1023

Number of the servo axis for each axis

Note

When this parameter is set, power must be turned off before operation is continued.

[Data type] Byte axis

[Valid data range] 1, 2, 3, ..., number of control axes

Set the servo axis for each control axis.

Usually set to same number as the control axis number.

The control axis number is the order number that is used for setting the axis-type parameters or axis-type machine signals

Examples

In case of 1 path control

(a) Main CPU board max. 4 axes + Additional board

(i) Parameter No. 1023

X	1
Y	2
Z	3
C	4
U	5
V	6
W	7
A	8

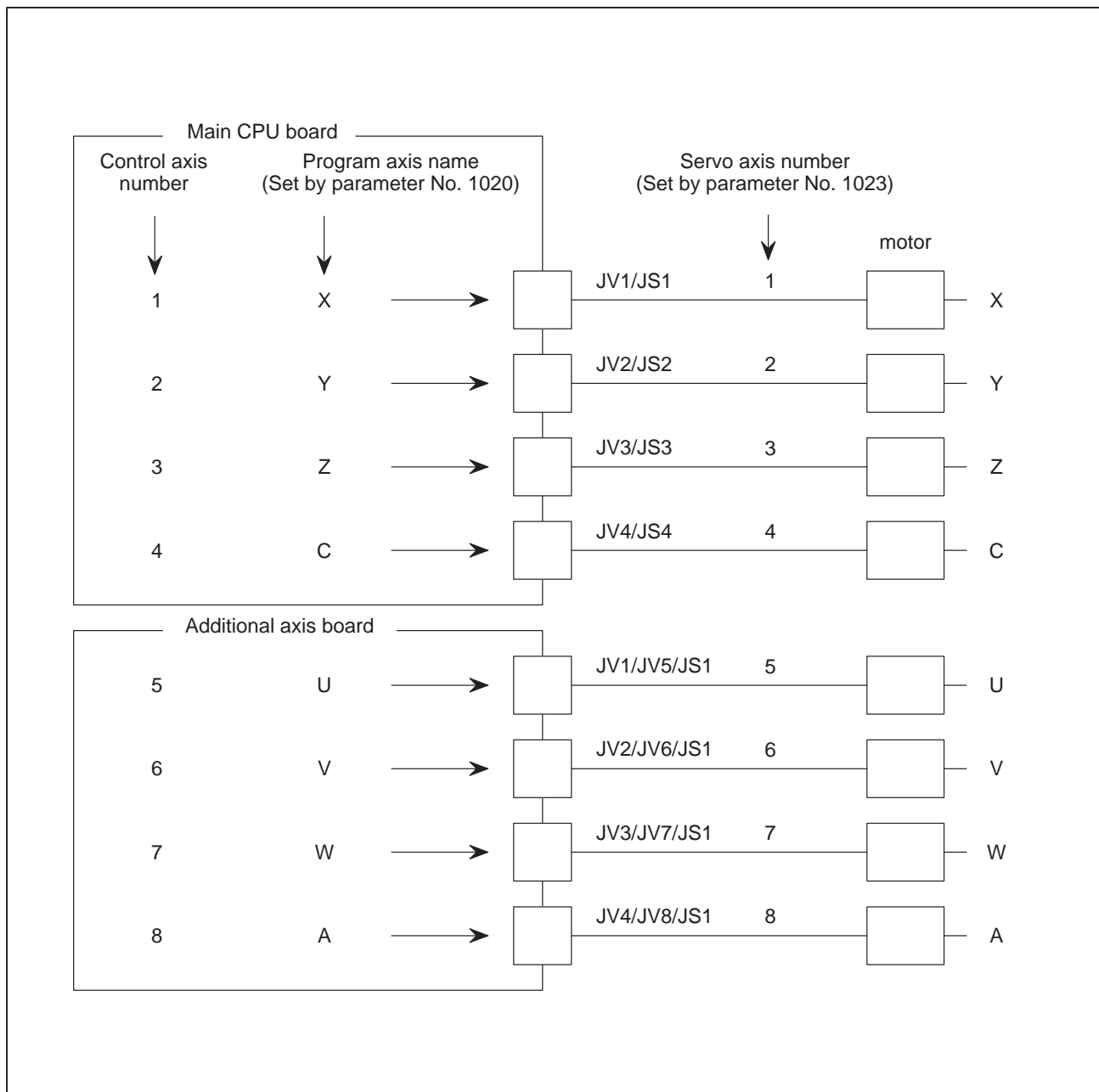

(ii) Parameter No. 1023

X	1
Y	3
Z	4
C	5
U	2
V	6
W	8
A	7

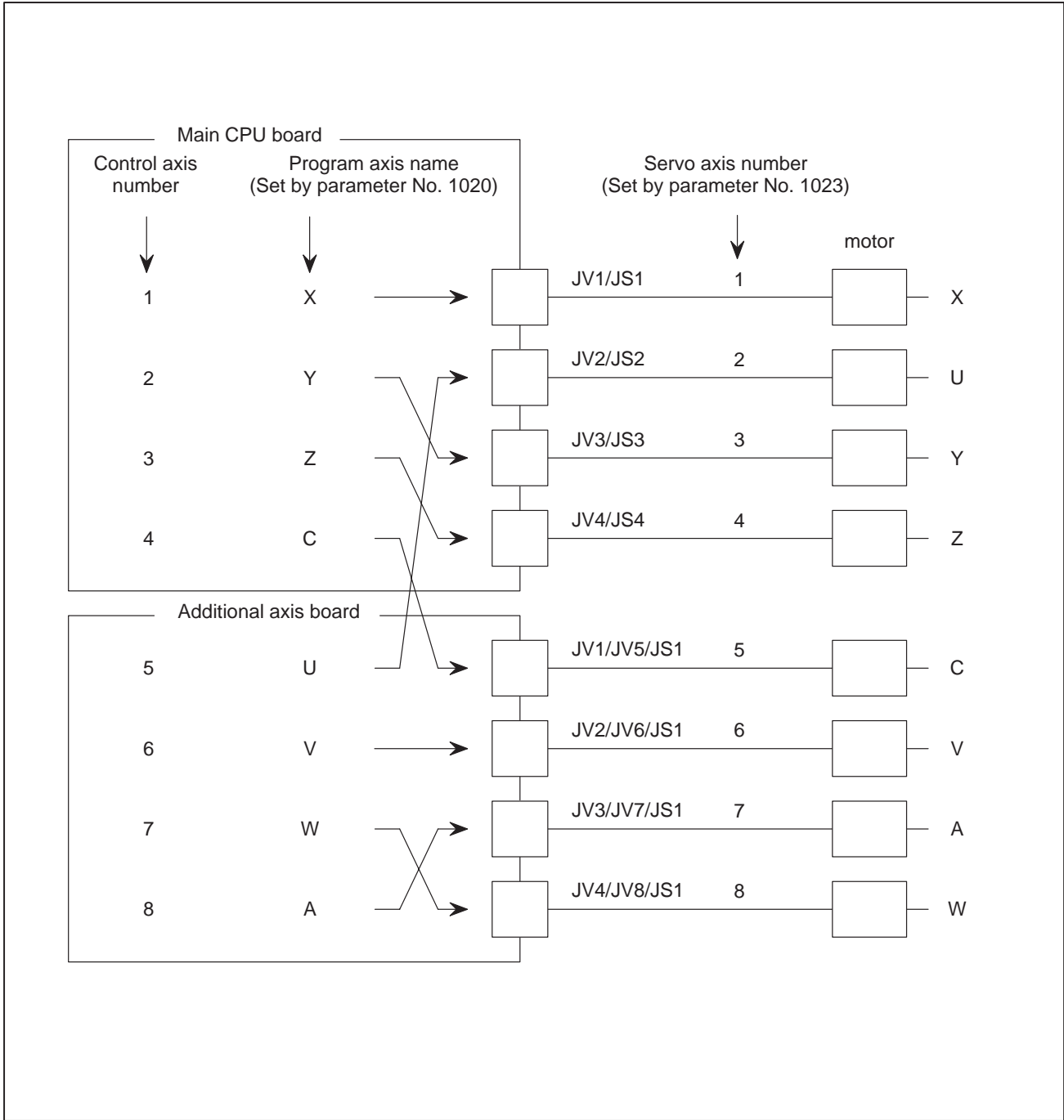

(b) Main CPU board max. 6 axes + Additional board

(i) Parameter No. 1023	X	1
	Y	2
	Z	3
	C	4
	U	5
	V	6
	W	7
	A	8

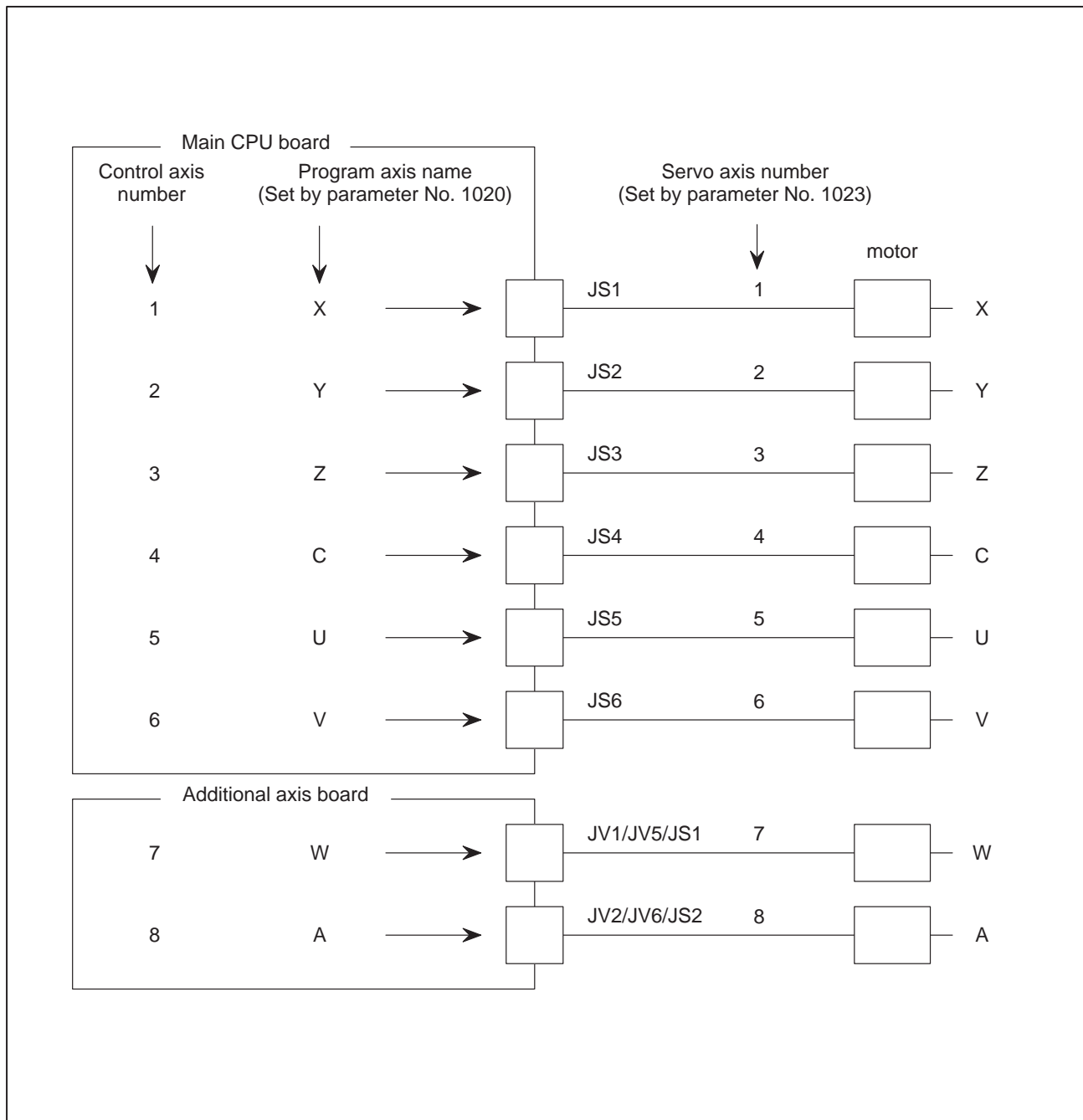

(ii) Parameter No. 1023

X	1
Y	3
Z	4
C	5
U	2
V	6
W	8
A	7

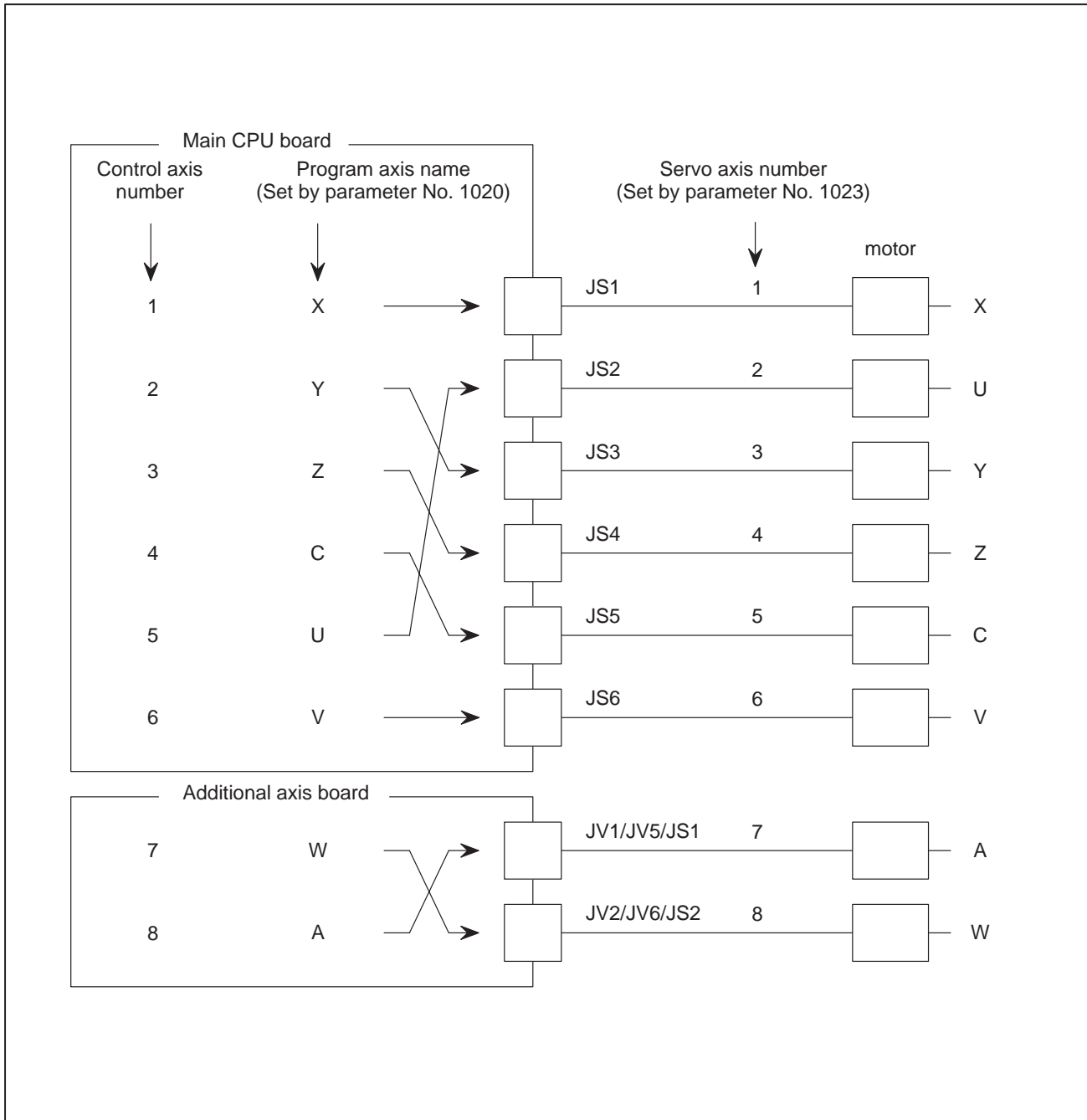

Examples

In case of 2 path control

(a) Main CPU board max. 4 axes + Sub CPU board max. 4 axes

(i) Parameter No. 1023	Path 1	path 2
	X ₁ 1	X ₂ 5
	Y ₁ 2	Y ₂ 6
	Z ₁ 3	Z ₂ 7
	C ₁ 4	C ₂ 8

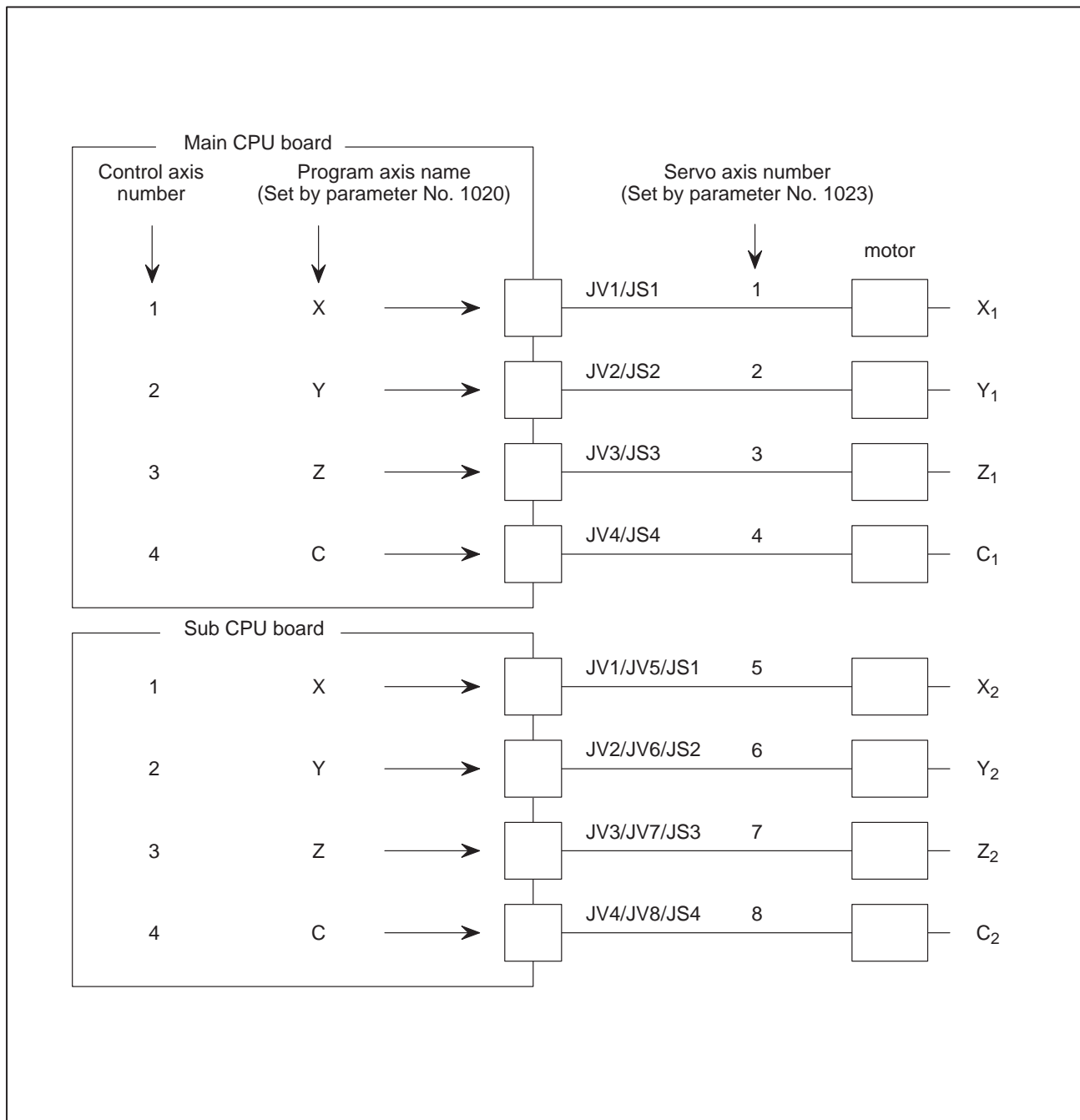

(ii) Parameter No. 1023

	Path 1	path 2
X ₁	1	X ₂ 5
Y ₁	3	Y ₂ 7
Z ₁	2	Z ₂ 6
C ₁	4	C ₂ 8

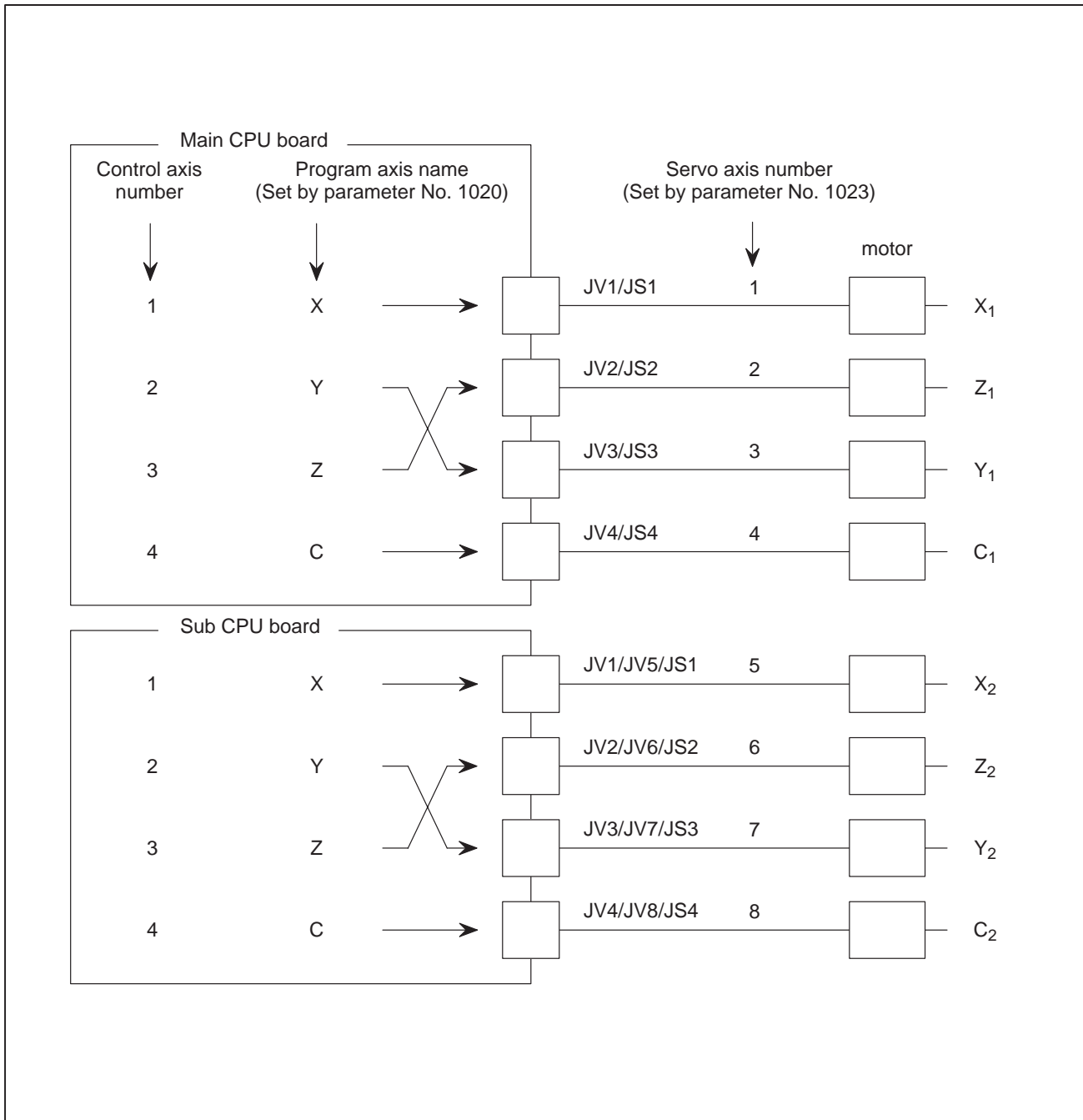

(b) Main CPU board max. 6 axes + Sub CPU board max. 6 axes

(i) Parameter No. 1023	Path 1	path 2
	X ₁ 1	X ₂ 7
	Y ₁ 2	Y ₂ 8
	Z ₁ 3	Z ₂ 9
	C ₁ 4	C ₂ 10
	U ₁ 5	U ₂ 11
	V ₁ 6	V ₂ 12

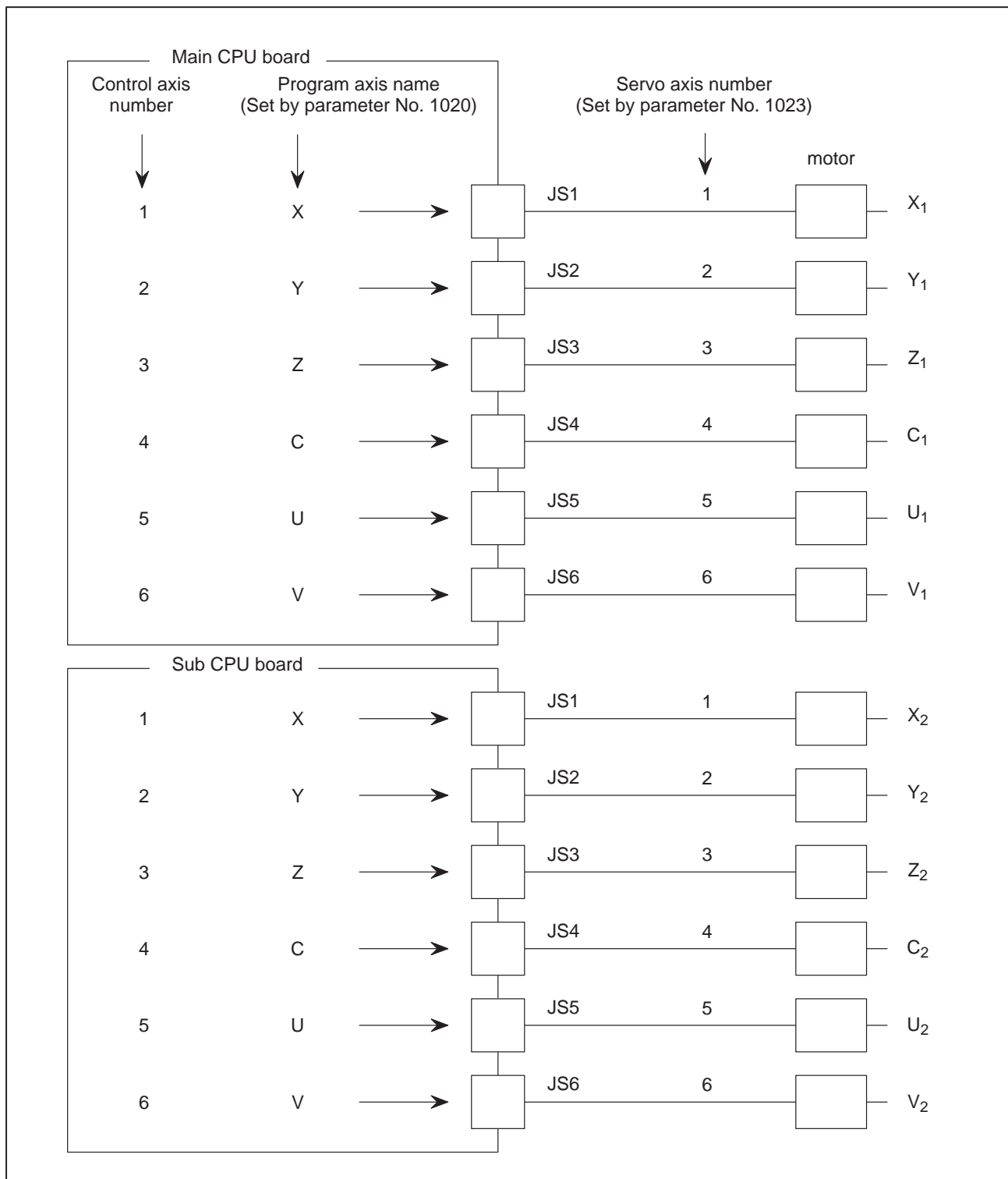

(ii) Parameter No. 1023

	Path 1	path 2
X ₁	1	X ₂ 7
Y ₁	4	Y ₂ 10
Z ₁	5	Z ₂ 11
C ₁	2	C ₂ 8
U ₁	3	U ₂ 9
V ₁	6	V ₂ 12

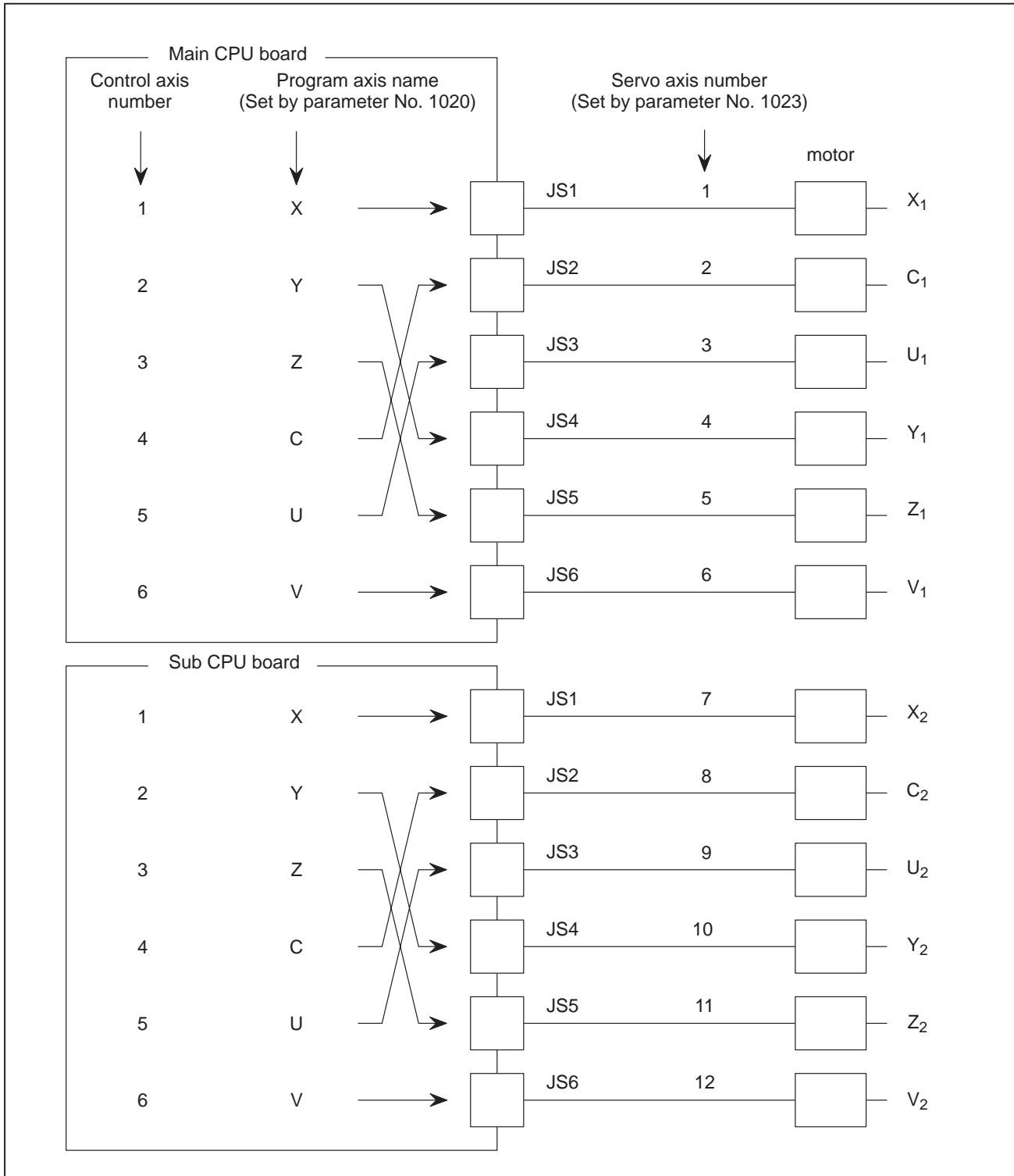

4.4 PARAMETERS OF COORDINATES

	#7	#6	#5	#4	#3	#2	#1	#0
1201	WZR		AWK		FPC	ZCL	ZPI	ZPR
			AWK		FPC	ZCL	ZPF	ZPR

[Data type] Bit

ZPR Automatic setting of a coordinate system when the manual reference position return is performed

0 : Not set automatically

1 : Set automatically

This bit is ineffective, when a workpiece coordinate system option is provided, however.

ZPI Coordinates at the reference position when a coordinate system is set automatically

0 : Value set in parameter No. 1250 is used.

1 : For input in mm, the value set in parameter 1250 is used, or for input in inches, the value set in parameter No. 1251 is used.

This bit is ineffective, when a workpiece coordinate system option is provided, however.

ZCL Local coordinate system when the manual reference position return is performed

0 : The local coordinate system is not canceled.

1 : The local coordinate system is canceled.

FPC When the floating reference position is specified using soft keys on the current position display screen

0 : The value of the displayed relative position is not preset. (In other words, the value does not change.)

1 : The value of the displayed relative position is preset to 0.

AWK Action taken after the workpiece zero point offset value is changed

0 : The absolute coordinate value is changed when the first automatic operation is performed.

1 : The absolute coordinate value is changed immediately.

WZR Upon reset, the workpiece coordinate system is:

0 : Not returned to that specified with G54

1 : Returned to that specified with G54

	#7	#6	#5	#4	#3	#2	#1	#0
1202					RLC	G50	EWS	EWD
					RLC			

[Data type] Bit

EWD The shift direction of the workpiece coordinate system is:

0 : The direction specified by the external workpiece zero point offset value

1 : In the opposite direction to that specified by the external workpiece zero point offset value

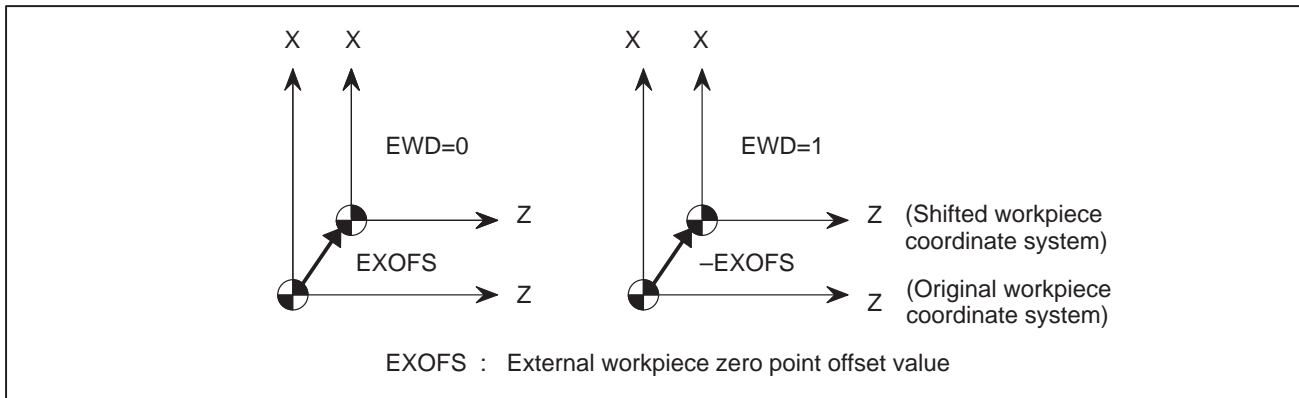

EWS Shift value of the workpiece coordinate system and external workpiece zero point offset value are
 0 : Stored in the separate memory areas.
 1 : Stored in the same memory area, that is, the shift and the offset values are the same.

G50 When the CNC has commands G54 to G59 specifying workpiece coordinate systems (optional function), if the G50 command for setting a coordinate system (or the G92 command in G command system B or C) is specified,

RLC Local coordinate system is
 0 : Not cancelled by reset
 1 : Cancelled by reset

1220	External workpiece zero point offset value
------	--------------------------------------------

[Data type] 2-word axis

[Unit of data]

Input increment	IS-A	IS-B	IS-C	Unit
Linear axis (input in mm)	0.01	0.001	0.0001	mm
Linear axis (input in inches)	0.001	0.0001	0.00001	inch
Rotation axis	0.01	0.001	0.0001	deg

[Valid data range] -7999 to 7999

This is one of the parameters that give the position of the origin of workpiece coordinate system (G54 to G59). It gives an offset of the workpiece origin common to all workpiece coordinate systems. In general, the offset varies depending on the workpiece coordinate systems. The value can be set from the PMC using the external data input function.

1221	Workpiece zero point offset value in workpiece coordinate system 1 (G54)
1222	Workpiece zero point offset value in workpiece coordinate system 2(G55)
1223	Workpiece zero point offset value in workpiece coordinate system 3(G56)
1224	Workpiece zero point offset value in workpiece coordinate system 4 (G57)
1225	Workpiece zero point offset value in workpiece coordinate system 5 (G58)
1226	Workpiece zero point offset value in workpiece coordinate system 6 (G59)

[Data type] 2-word axis

[Unit of data]

Input increment	IS-A	IS-B	IS-C	Unit
Linear axis (input in mm)	0.01	0.001	0.0001	mm
Linear axis (input in inches)	0.001	0.0001	0.00001	inch
Rotation axis	0.01	0.001	0.0001	deg

[Valid data range] -99999999 to 99999999

The workpiece zero point offset values in workpiece coordinate systems 1 to 6 (G54 to G59) are set.

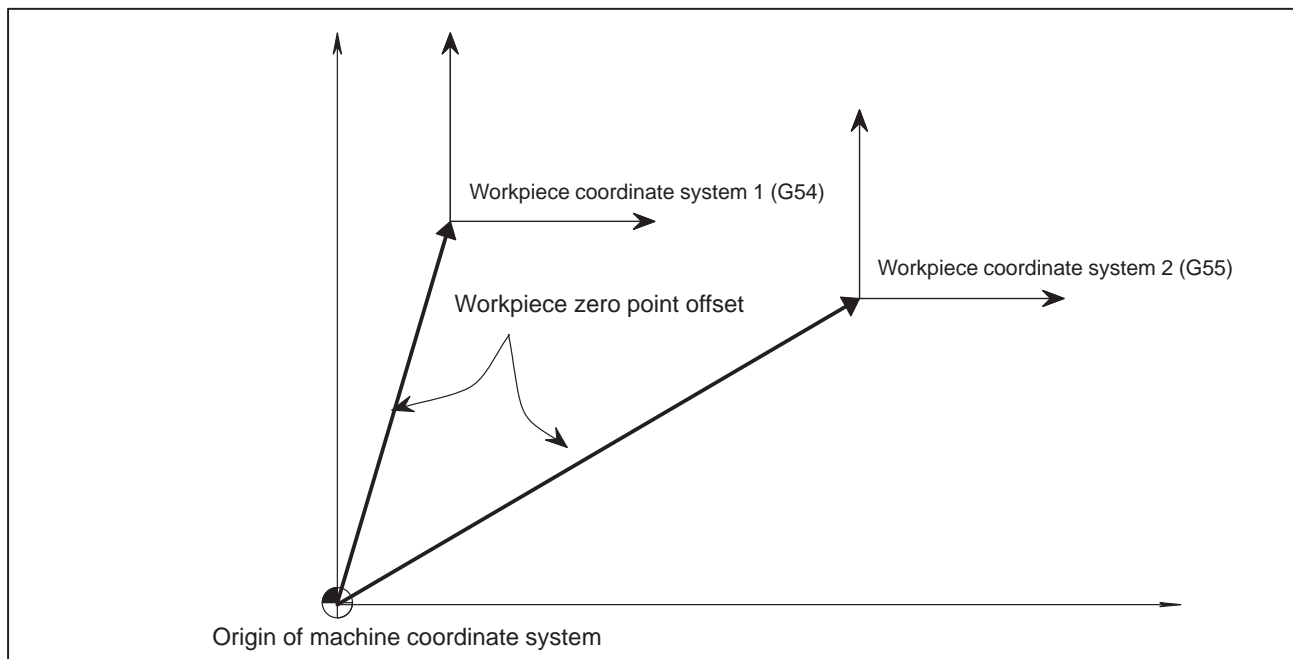

- 1240 Coordinate value of the reference position on each axis in the machine coordinate system
- 1241 Coordinate value of the second reference position on each axis in the machine coordinate system
- 1242 Coordinate value of the third reference position on each axis in the machine coordinate system
- 1243 Coordinate value of the fourth reference position on each axis in the machine coordinate system

[Data type] 2-word axis

[Unit of data]

Increment system	IS-A	IS-B	IS-C	Unit
Millimeter machine	0.01	0.001	0.0001	mm
Inch machine	0.001	0.0001	0.00001	inch
Rotation axis	0.01	0.001	0.0001	deg

[Valid data range] -99999999 to 99999999

Set the coordinate values of the reference positions in the machine coordinate system.

1244

Coordinates of the floating reference position for each axis

[Data type] 2-word axis**[Unit of data]**

Increment system	IS-A	IS-B	IS-C	Unit
Millimeter machine	0.01	0.001	0.0001	mm
Inch input	0.001	0.0001	0.00001	inch
Rotation axis	0.01	0.001	0.0001	deg

[Valid data range] -99999999 to 99999999

This parameter specifies the coordinates of the floating reference position for each axis. The parameter is automatically set when the floating reference position is specified using soft keys on the current position display screen.

1250

Coordinate value of the reference position used when automatic coordinate system setting is performed

[Data type] 2-word axis**[Unit of data]**

Input increment	IS-A	IS-B	IS-C	Unit
Linear axis (input in mm)	0.01	0.001	0.0001	mm
Linear axis (input in inches)	0.001	0.0001	0.00001	inch
Rotation axis	0.01	0.001	0.0001	deg

[Valid data range] -99999999 to 99999999

Set the coordinate value of the reference position on each axis to be used for setting a coordinate system automatically.

1251

Coordinate value of the reference position on each axis used for setting a coordinate system automatically when input is performed in inches

[Data type] 2-word axis**[Unit of data]**

Increment system	IS-A	IS-B	IS-C	Unit
Linear axis (input in inches)	0.001	0.0001	0.00001	inch

[Valid data range] -99999999 to 99999999

Set the coordinate value of the reference position on each axis to be used for setting a coordinate system automatically when input is performed in inches.

Note

This parameter is valid when ZPI in parameter 1201 is set to 1.

1260

Amount of a shift per one rotation of a rotation axis

Note

After setting the parameter, turn off the power once and turn it on again to operate the machine.

[Data type] 2-word axis

[Unit of data]

Increment system	Unit of data	Standard value
IS-A	0.01 deg	36000
IS-B	0.001 deg	360000
IS-C	0.0001 deg	3600000

[Valid data range] 1000 to 9999999

Set the amount of a shift per one rotation of a rotation axis.

1290

Distance between two opposite tool posts in mirror image

[Data type] 2-word

[Unit of data]

Increment system	IS-A	IS-B	IS-C	Unit
Millimeter machine	0.01	0.001	0.0001	mm
Inch machine	0.001	0.0001	0.00001	inch

[Valid data range] 0 to 99999999

Set the distance between two opposite tool posts in mirror image.

4.5 PARAMETERS OF STROKE LIMIT

	#7	#6	#5	#4	#3	#2	#1	#0
1300	BFA	LZR	RL3			LMS		OUT

[Data type] Bit

- OUT** The area inside or outside of the stored stroke limit 2 is set as an inhibition area.
0: Inside
1: Outside
- LMS** The EXLM signal for switching stored stroke limit 1
0: Disabled
1: Enabled
- RL3** Stored stroke limit3 release signal RLSOT3 is
0: Disabled
1: Enabled
- LZR** Checking of stored stroke limit 1 during the time from power-on to the manual position reference return
0: The stroke limit 1 is checked.
1: The stroke limit 1 is not checked
- BFA** When a command that exceeds a stored stroke limit is issued
0: An alarm is generated after the stroke limit is exceeded.
1: An alarm is generated before the stroke limit is exceeded.

Note

When an absolute position detector is used and a reference position is already set upon power-up, stored stroke limit check 1 is started immediately after power-up, regardless of the setting.

	#7	#6	#5	#4	#3	#2	#1	#0
1301	PLC					NPC		

[Data type] Bit

- NPC** As part of the stroke limit check performed before movement, the movement specified in G31 (skip) and G37 (automatic tool length measurement (for M series) or automatic tool compensation (for T series)) blocks is:
0: Checked
1: Not checked
- PLC** Stroke limit check before movement is:
0: Not performed
1: Performed

	#7	#6	#5	#4	#3	#2	#1	#0
1310							OT3x	OT2x
								OT2x

[Data type] Bit axis

OT2x Whether stored stroke limit 2 is checked for each axis is set.

0: Stored stroke limit 2 is not checked.

1: Stored stroke limit 2 is checked.

OT3x Whether stored stroke limit 3 is checked for each axis is set.

0: Stored stroke limit 3 is not checked.

1: Stored stroke limit 3 is checked.

1320	Coordinate value l of stored stroke limit 1 in the positive direction on each axis
1321	Coordinate value l of stored stroke limit 1 in the negative direction on each axis

[Data type] 2-word axis

Increment system	IS-A	IS-B	IS-C	Unit
Millimeter machine	0.01	0.001	0.0001	mm
Inch machine	0.001	0.0001	0.00001	inch
Rotation axis	0.01	0.001	0.0001	deg

[Valid data range] -99999999 to 99999999

The coordinate values of stored stroke limits 1 in the positive and negative directions are set for each axis in the machine coordinate system. The outside area of the two limits set in the parameters is inhibited.

Note

1 For axes with diameter specification, a diameter value must be set.

2 When the parameters are set as follows, the stroke becomes infinite:

parameter 1320 < parameter 1321

For movement along the axis for which infinite stroke is set, only increment commands are available. If an absolute command is issued for this axis, the absolute register may overflow, and normal movement will not result.

1322	Coordinate value of stored stroke limit 2 in the positive direction on each axis
1323	Coordinate value of stored stroke limit 2 in the negative direction on each axis

[Data type] 2-word axis

[Unit of data]

Increment system	IS-A	IS-B	IS-C	Unit
Millimeter machine	0.01	0.001	0.0001	mm
Inch machine	0.001	0.0001	0.00001	inch
Rotation axis	0.01	0.001	0.0001	deg

[Valid data range] –99999999 to 99999999

Set the coordinate values of stored stroke limits 2 in the positive and negative directions for each axis in the machine coordinate system. OUT, #0 of parameter 1300, sets either the area outside of the area inside specified by two limits as the inhibition area.

Note

For axes with diameter specification, a diameter value must be set.

1324 Coordinate value of stored stroke limit 3 in the positive direction on each axis

1325 Coordinate value of stored stroke limit 3 in the negative direction on each axis

[Data type] 2–word axis

[Unit of data]

Increment system	IS–A	IS–B	IS–C	Unit
Millimeter machine	0.01	0.001	0.0001	mm
Inch machine	0.001	0.0001	0.00001	inch
Rotation axis	0.01	0.001	0.0001	deg

[Valid data range] –99999999 to 99999999

Set the coordinate values of stored stroke limits 3 in the positive and negative directions for each axis in the machine coordinate system. The area inside the limits set in the parameter is inhibited.

1326 Coordinate value II of stored stroke limit 1 in the positive direction on each axis

1327 Coordinate value II of stored stroke limit 1 in the negative direction on each axis

[Data type] 2–word axis

[Unit of data]

Increment system	IS–A	IS–B	IS–C	Unit
Millimeter machine	0.01	0.001	0.0001	mm
Inch machine	0.001	0.0001	0.00001	inch
Rotation axis	0.01	0.001	0.0001	deg

[Valid data range] –99999999 to 99999999

Set the coordinate values of stored stroke limits 1 in the positive and negative directions for each axis in the machine coordinate system.

When stroke limit switching signal EXLM is ON, stroke limits are checked with parameters 1326 and 1327, not with parameters 1320 and 1321. The area outside that set by parameters 1326 and 1327 is inhibited.

Note

The EXLM signal is enabled only when LMS, #2 of parameter 1300, is set to 1.

4.6 PARAMETERS OF THE CHUCK AND TAILSTOCK BARRIER (16-TB)

1330	Profile of a chuck
------	--------------------

[Data type] Byte

[Valid data range] 0 or 1

0: Chuck which holds a workpiece on the inner surface

1: Chuck which holds a workpiece on the outer surface

1331	Dimensions of the claw of a chuck (L)
------	---------------------------------------

1332	Dimensions of the claw of a chuck (W)
------	---------------------------------------

1333	Dimensions of the part of a claw at which a workpiece is held (L1)
------	--------------------------------------------------------------------

1334	Dimensions of the part of a claw at which a workpiece is held (W1)
------	--------------------------------------------------------------------

1335	X coordinate of a chuck (CX)
------	------------------------------

1336	ZX coordinate of a chuck (CZ)
------	-------------------------------

[Data type] 2-word

[Unit of data]

Increment system	IS-B	IS-C	Unit
Millimeter machine	0.001	0.0001	mm
Inch machine	0.0001	0.00001	inch

[Valid range] No. 1331 to No. 1334: 0 to 99999999

No. 1335 to No. 1336: -99999999 to 99999999

Specify the profile of a chuck.

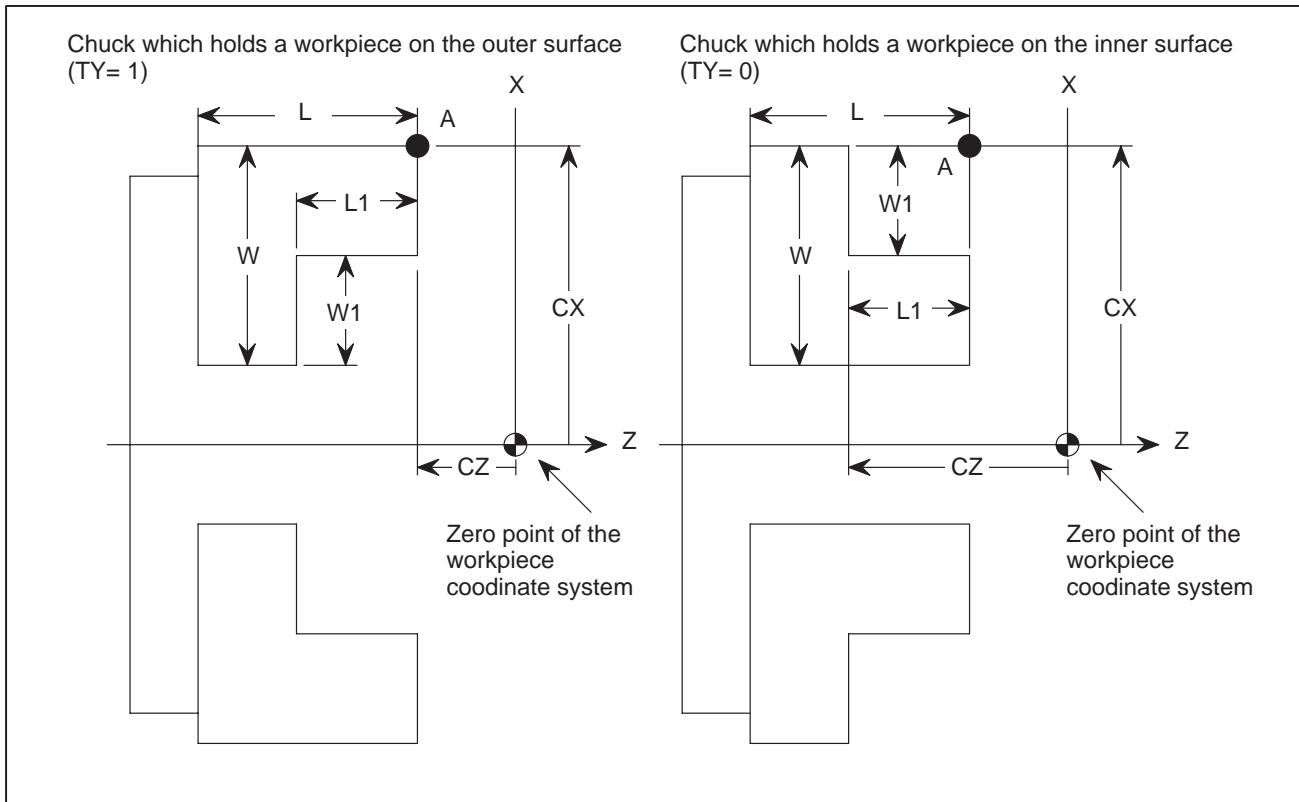

Symbol	Description
Ty	Profile of a chuck (0: Chuck which holds a workpiece on the inner surface, 1: Chuck which holds a workpiece on the outer surface)
CX	X coordinate of a chuck
CZ	Z coordinate of a chuck
L	Dimensions of the claw of a chuck
W	Dimensions of the claw of a chuck (radius input)
L ₁	Dimensions of the part of a claw at which a workpiece is held
W ₁	Dimensions of the part of a claw at which a workpiece is held (radius input)

TY Specifies the profile of a chuck. When TY is set to 0, the chuck holding a workpiece on the inner surface is specified. When TY is set to 1, the chuck holding a workpiece on the outer surface is specified. The profile of the chuck is assumed to be symmetrical with respect to the z-axis.

CX, and CZ Specify the position (point A) of a chuck with the coordinates of the workpiece coordinate system. In this case, do not use the coordinates of the machine coordinate system.

Note

Specifying the coordinates with a diameter or radius depends on whether the corresponding axis conforms to diameter or radius specification. When the axis conforms to diameter specification, specify the coordinates with a diameter.

L, L₁, W and W₁ Define the profile of a chuck.

Note

Always specify W and W1 with radiuses. Specify L and L1 with radiuses when the Z-axis conforms to radius specification.

1341	Length of a tailstock (L)
1342	Diameter of a tailstock (D)
1343	Length of a tailstock (L1)
1344	Diameter of a tailstock (D1)
1345	Length of a tailstock (D1)
1346	Diameter of a tailstock (D2)
1347	Diameter of the hole of a tailstock (D3)
1348	Z coordinate of a tailstock (TZ)

[Data type] 2-words

[Unit of data]

Increment system	IS-B	IS-C	Unit
Millimeter machine	0.001	0.0001	mm
Inch machine	0.0001	0.00001	inch

[Valid range] No. 1341 to No. 1347: 0 to 99999999
 No. 1348: -99999999 to 99999999

Specify the profile of a tailstock.

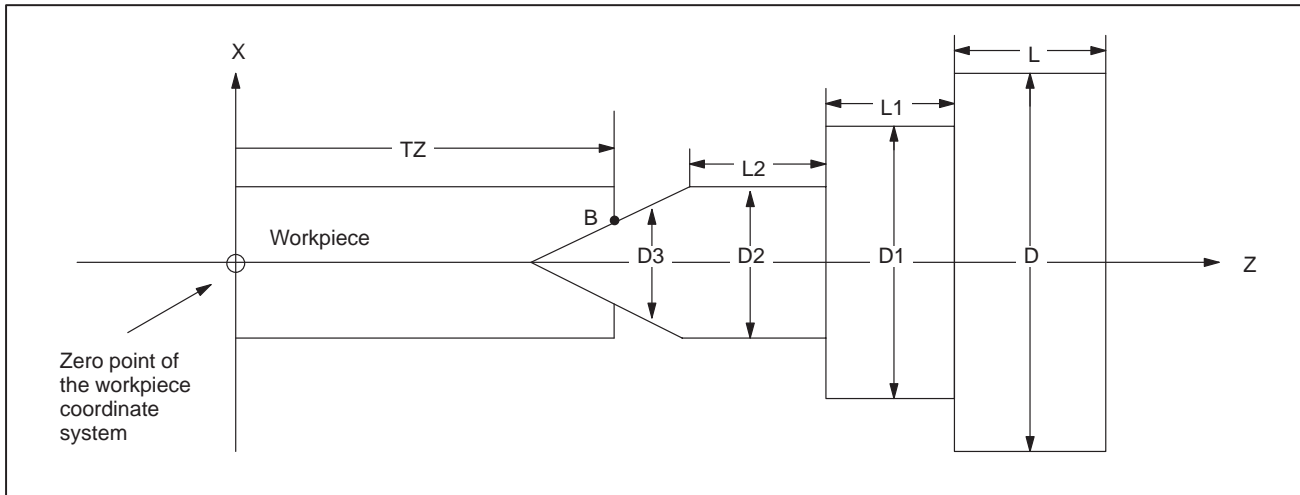

Symbol	Description
TZ	Z-axis coordinate of a tailstock
L	Length of a tailstock
D	Diameter of a tailstock (diameter input)
L1	Length of a tailstock (1)
D1	Diameter of a tailstock (1) (diameter input)
L2	Length of a tailstock (2)
D2	Diameter of a tailstock (2) (diameter input)
D3	Diameter of the hole of a tailstock (diameter input)

TZ: Specifies the position (point B) of a tailstock with the Z-axis coordinate of the workpiece coordinate system. In this case, do not use the coordinate of the machine coordinate system. The profile of a tailstock is assumed to be symmetrical with respect to the Z-axis.

Note

Specifying the position of a tailstock with a radius or diameter depends on whether the Z-axis conforms to radius or diameter specification.

L, L1, L2, D, D1, D2, and D3:

Define the profile of a tailstock.

Note

Always specify D, D1, D2, and D3 with diameters. Specify L, L1, and L2 with radiuses if the Z-axis conforms to radius specification.

4.7 PARAMETERS OF FEEDRATE

	#7	#6	#5	#4	#3	#2	#1	#0
1401		RDR	TDR	RFO		JZR	LRP	RPD
		RDR	TDR	RFO			LRP	RPD

[Data type] Bit

RPD Manual rapid traverse during the period from power-on time to the completion of the reference position return.

0: Disabled (Jog feed is performed.)

1: Enabled

LRP Positioning (G00)

0: Positioning is performed with non-linear type positioning so that the tool moves along each axis independently at rapid traverse.

1: Positioning is performed with linear interpolation so that the tool moves in a straight line.

JZR The manual reference position return at JOG feedrate

0: Not performed

1: Performed

RFO When cutting feedrate override is 0% during rapid traverse,

0: The machine tool does not stop moving.

1: The machine tool stops moving.

TDR Dry run during threading or tapping (tapping cycle G74 or G84, rigid tapping)

0: Enabled

1: Disabled

RDR Dry run for rapid traverse command

0: Disabled

1: Enabled

	#7	#6	#5	#4	#3	#2	#1	#0
1402				JRV	OV2			NPC
					OV2			NPC

[Data type] Bit

NPC The feed per rotation command is:

0: Ineffective when a position coder is not provided.

1: Effective even when a position coder is not provided (because the CNC converts it to the feed per minute command automatically).

OV2 2nd feedrate override is

0: specified every 1%

1: specified every 0.01%

Note

Signals used for 2nd feedrate override are:
 *AFV0 to AFV7 (G013) when OV2 = 0
 *APF00 to *AFP15 (G094, G095) when OV2 = 1

JRV Manual continuous feed (jog feed)
 0: Jog feed is performed at feed per minute.
 1: Jog feed is performed at feed per rotation.

Note

Specify a feedrate in parameter No. 1423.

	#7	#6	#5	#4	#3	#2	#1	#0
1403	RTV							MIF

Note

When this parameter is set, the power must be turned off before operation is continued.

[Data type] Bit

MIF Cutting feedrates at feed per minute is specified by F commands
 0: In units of 1 mm/min for millimeter machines or 0.01 inches/min for inch machines.
 1: In unit of 0.001 mm/min for millimeter machines or 0.00001 inches/min for inch machines.

Note

M series are not equipped with this parameter. Cutting feedrates are specified by F commands in units of 0.001 mm/min for millimeter machines or 0.00001 inches/min for inch machines.

RTV Override while the tool is retracting in threading
 0 : Override is effective.
 1 : Override is not effective.

	#7	#6	#5	#4	#3	#2	#1	#0
1404						F8A	DLF	HFC
						F8A	DLF	HFC

Note

When this parameter is set, the power must be turned off before operation is continued.

[Data type] Bit**HFC** The feedrate for helical interpolation is:

0: Clamped so that the feedrates along an arc and linear axis do not exceed the maximum cutting feedrate specified by parameter.

1: Clamped so that the composite feedrate along an arc and linear axis does not exceed the maximum cutting feedrate specified by parameter.

DLF After a reference position is set, manual reference position return performed at:

0 : Rapid traverse rate (parameter No. 1420)

1 : Manual rapid traverse rate (parameter No.1424)

Note

This parameter selects a feedrate for reference position return performed without dogs. This parameter also selects a feedrate when manual reference position return is performed according to bit 7 (SJZ) of parameter No. 0002 using rapid traverse without deceleration dogs after a reference position is set.

<For T series>

F8A Valid data range for an F command in feed-per-minute mode

0: Range specified with bit 0 (MIF) of parameter No. 1403

1:	Increment system	Units	IS-A, IS-B	IS-C
	Millimeter input	mm/min	0.001-240000.	0.001-100000.
	Inch input	inch/min	0.00001-9600.	0.00001-4000.
	Rotation axis	deg/min	1-240000.	1-100000.

<For M series>

F8A Valid data range for an F command with a decimal point in feed-per-minute mode

0:	Increment system	Units	IS-A, IS-B	IS-C
	Millimeter input	mm/min	0.001-99999.999.	
	Inch input	inch/min	0.00001-999.99999.	
	Rotation axis (mm)	deg/min	1-240000.	1-100000.
	Rotation axis (inch)	deg/min	1-9600.	1-4000.

1:	Increment system	Units	IS-A, IS-B	IS-C
	Millimeter input	mm/min	0.001-240000.	0.001-100000.
	Inch input	inch/min	0.00001-9600.	0.00001-4000.
	Rotation axis	deg/min	1-240000.	1-100000.

1410	Dry run rate
------	--------------

[Data type] Word

[Unit of data]

[Valid data range]

Increment system	Unit of data	Valid data range	
		IS-A, IS-B	IS-C
Millimeter machine	1 mm/min	6 – 15000	6 – 12000
Inch machine	0.1 inch/min	6 – 6000	6 – 4800

Set the dry run rate when the manual feedrate is overridden by 100%.

Specify the jog feedrate when the override is 100% for manual linear or circular interpolation.

1411	Cutting feedrate in the automatic mode at power-on
------	----------------------------------------------------

Setting entry is acceptable.

[Data type] Word

[Unit of data]

[Valid data range]

Increment system	Unit of data	Valid data range	
		IS-A, IS-B	IS-C
Millimeter machine	1 mm/min	6 – 32767	6 – 32767
Inch machine	0.1 inch/min	6 – 32767	6 – 32767

When the machine requires little change in cutting feedrate during cutting, a cutting feedrate can be specified in the parameter. This eliminates the need to specify a cutting feedrate in the NC command data.

1414	Feedrate for retrace
------	----------------------

[Data type] 2-word

This parameter sets the feedrate for retrace when the retrace function is used.

(1) For rapid traverse

[Unit of data]

[Valid data range]

Increment system	Unit of data	Valid data range	
		IS-A, IS-B	IS-C
Millimeter machine	1 mm/min	6 to 240000	6 to 100000
Inch machine	0.1 inch/min	6 to 96000	6 to 48000
Rotation axis	1 deg/min	6 to 240000	6 to 100000

Note

When 0 is set in this parameter, the rapid traverse rate that is set in parameter No. 1420 is used for retrace.

(2) For cutting feed

When a value other than 0 is specified in this parameter, the same feedrate as an F command specified using the value without a decimal point is set and is used for retrace. When 0 is specified in this parameter, the programmed feedrate (F command) is used for retrace.

1420

Rapid traverse rate for each axis

[Data type] 2-word axis

[Unit of data]

[Valid data range]

Increment system	Unit of data	Valid data range	
		IS-A, IS-B	IS-C
Millimeter machine	1 mm/min	30 to 240000	6 to 100000
Inch machine	0.1 inch/min	30 to 96000	6 to 48000
Rotation axis	1 deg/min	30 to 240000	6 to 100000

Set the rapid traverse rate when the rapid traverse override is 100% for each axis.

1421

F0 rate of rapid traverse override for each axis

[Data type] Word axis

[Unit of data]

[Valid data range]

Increment system	Unit of data	Valid data range	
		IS-A, IS-B	IS-C
Millimeter machine	1 mm/min	30 - 15000	30 - 12000
Inch machine	0.1 inch/min	30 - 6000	30 - 4800
Rotation axis	1 deg/min	30 - 15000	30 - 12000

Set the F0 rate of the rapid traverse override for each axis.

Rapid traverse override signal		Override value
ROV2	ROV1	
0	0	100%
0	1	50%
1	0	25%
1	1	F0

F0: Parameter 1421

1442

Maximum cutting feedrate for all axes

[Data type] 2-word**[Unit of data]****[Valid data range]**

Increment system	Unit of data	Valid data range	
		IS-A, IS-B	IS-C
Millimeter machine	1 mm/min	6 – 240000	6 – 100000
Inch machine	0.1 inch/min	6 – 96000	6 – 48000

Specify the maximum cutting feedrate.

A feedrate in the tangential direction is clamped in cutting feed so that it does not exceed the feedrate specified in this parameter.

Note

To specify the maximum cutting feedrate for each axis, use parameter No. 1430 instead.

1423

Feedrate in manual continuous feed (jog feed) for each axis

[Data type] Word axis

- (1) In M series, or in T series when JRV, bit 4 of parameter No. 1402, is set to 0 (feed per minute), specify a jog feedrate at feed per minute with an override of 100%.

[Unit of data, valid range]

Increment system	Unit of data	Valid data range	
		IS-A, IS-B	IS-C
Millimeter machine	1 mm/min	6–32767	
Inch machine	0.1 inch/min		
Rotation axis	1 deg/min		

- (2) When JRV, bit 4 of parameter No. 1402, is set to 1 (feed per revolution) in T series, specify a jog feedrate (feed per revolution) under an override of 100%.

[Unit of data, valid range]

Increment system	Unit of data	Valid data range
Millimeter machine	0.01 mm/rev	0 – 32767
Inch machine	0.001 mm/rev	
Rotation axis	0.01 deg/rev	

1424

Manual rapid traverse rate for each axis

[Data type] 2-word axis**[Unit of data]****[Valid data range]**

Increment system	Unit of data	Valid data range	
		IS-A, IS-B	IS-C
Millimeter machine	1 mm/min	30 – 240000	30 – 100000
Inch machine	0.1 inch/min	30 – 96000	30 – 48000
Rotation axis	1 deg/min	30 – 240000	30 – 100000

Set the rate of manual rapid traverse when the rapid traverse override is 100% for each axis.

Note

If 0 is set, the rate set in parameter 1420 is assumed.

1425

FL rate of the reference position return for each axis

[Data type] Word axis**[Unit of data]****[Valid data range]**

Increment system	Unit of data	Valid data range	
		IS-A, IS-B	IS-C
Millimeter machine	1 mm/min	6 – 15000	6 – 12000
Inch machine	0.1 inch/min	6 – 6000	6 – 4800
Rotation axis	1 deg/min	6 – 15000	6 – 12000

Set feedrate (FL rate) after deceleration when the reference position return is performed for each axis.

1426

External deceleration rate of cutting feed

[Unit of data]**[Valid data range]**

Increment system	Unit of data	Valid data range	
		IS-A, IS-B	IS-C
Millimeter machine	1 mm/min	6 – 15000	6 – 12000
Inch machine	0.1 inch/min	6 – 6000	6 – 4800

Set the external deceleration rate of cutting feed.

1427

External deceleration rate of rapid traverse for each axis

[Data type] Word axis**[Unit of data]****[Valid data range]**

Increment system	Unit of data	Valid data range	
		IS-A, IS-B	IS-C
Millimeter machine	1 mm/min	6 – 15000	6 – 12000
Inch machine	0.1 inch/min	6 – 6000	6 – 4800
Rotation axis	1 deg/min	6 – 15000	6 – 12000

Set the external deceleration rate of rapid traverse for each axis.

1428

Reference position return feedrate

[Data type] 2-word axis**[Unit of data]****[Valid data range]**

Increment system	Unit of data	Valid data range	
		IS-A, IS-B	IS-C
Millimeter machine	1 mm/min	30 – 240000	6 – 100000
Inch machine	0.1 inch/min	30 – 96000	6 – 48000
Rotation axis	1 deg/min	30 – 240000	6 – 100000

This parameter sets a rapid traverse rate for reference position return operation using deceleration dogs, or for reference position return operation before a reference position is set.

This parameter is also used to set a feedrate for the rapid traverse command (G00) in automatic operation before a reference position is set.

Note

This parameter is enabled when the reference position return feedrate setting function is used. When 0 is set in this parameter, this parameter disables the reference position return feedrate setting function.

		Before a reference position is set		After a reference position is set	
		Reference position return feedrate setting function		Reference position return feedrate setting function	
		Disabled	Enabled	Disabled	Enabled
Reference position return by G28		No.1420	No.1428	No.1420	
Rapid traverse command (G00) in automatic operation				No.1420 or No.1424*3	
Manual reference position return	Without dogs*1	No.1424		No.1424	No.1428
	With dogs*1				
Manual rapid traverse		No.1423 or No.1424*2		No.1424	

- *1 With/without dogs: Reference position return operation not using/using deceleration dogs
- *2 For manual rapid traverse before a reference position is set, a jog feedrate (parameter No. 1423) or manual rapid traverse rate (parameter No. 1424) is used according to the setting of bit 0 (RPD) of parameter No. 1401.
- *3 The rapid traverse rate set in parameter No. 1424 or No.1420 is used according to the setting of bit 1 (DLF) of parameter No.1404 when reference position return is performed without dogs, or when reference position return operation is performed with bit 7 (SJZ) of parameter No. 0002 set to 1 after a reference position is set (when reference position return operation is performed using rapid traverse without deceleration dogs).

1430	
	Maximum cutting feedrate for each axis

[Data type] 2–word axis

Increment system	Unit of data	Valid data range	
		IS–A, IS–B	IS–C
Millimeter machine	1 mm/min	6 – 240000	6 – 100000
Inch machine	0.1 inch/min	6 – 96000	6 – 48000
Rotation axis	1 deg/min	6 – 240000	6 – 100000

Specify the maximum cutting feedrate for each axis.

A feedrate for each axis is clamped in cutting feed so that it does not exceed the maximum feedrate specified for each axis.

Notes

- 1 This parameter is effective only in linear and circular interpolation. In polar coordinate, cylindrical, and involute interpolation, the maximum feedrate for all axes specified in parameter No. 1422 is effective.
- 2 If the setting for each axis is 0, the maximum feedrate specified in parameter No. 1422 is applied to all axes and the feedrate is clamped at the maximum feedrate.

1431	
	Maximum cutting feedrate for all axes in the look-ahead control mode

[Data type] 2–words

[Unit of data, valid range]

Increment system	Unit of data	Valid data range	
		IS–A, IS–B	IS–C
Millimeter machine	1 mm/min	0 – 240000	0 – 100000
Inch machine	0.1 inch/min	0 – 96000	0 – 48000
Rotation axis	1 deg/min	0 – 240000	0 – 100000

Specify the maximum cutting feedrate for all axes in the look-ahead control mode.

A feedrate in the tangential direction is clamped in cutting feed so that it does not exceed the feedrate specified in this parameter.

Notes

- 1 To specify the maximum cutting feedrate for each axis, use parameter No. 1432 instead.
- 2 In a mode other than the look-ahead mode, the maximum cutting feedrate specified in parameter No. 1422 or No. 1430 is applied and the feedrate is clamped at the maximum feedrate.

1432

Maximum cutting feedrate for each axis in the look-ahead control mode

[Data type] 2-word axis

[Unit of data, valid range]

Increment system	Unit of data	Valid data range	
		IS-A, IS-B	IS-C
Millimeter machine	1 mm/min	0 – 240000	0 – 100000
Inch machine	0.1 inch/min	0 – 96000	0 – 48000
Rotation axis	1 deg/min	0 – 240000	0 – 100000

Specify the maximum cutting feedrate for each axis in the look-ahead control mode.

A feedrate for each axis is clamped during cutting feed so that it does not exceed the maximum cutting feedrate specified for each axis.

Notes

- 1 This parameter is effective only in linear and circular interpolation. In polar coordinate, cylindrical, and involute interpolation, the maximum feedrate for all axes specified in parameter No. 1431 is effective.
- 2 If a setting for each axis is 0, the maximum feedrate specified in parameter No. 1431 is applied to all axes and the feedrate is clamped at the maximum feedrate.
- 3 In a mode other than the look-ahead mode, the maximum cutting feedrate specified in parameter No. 1422 or No. 1430 is applied and the feedrate is clamped at the maximum feedrate.

1450	Change of feedrate for one graduation on the manual pulse generator during F1 digit feed
------	------------------------------------------------------------------------------------------

[Data type] Byte

[Valid data range] 1 to 127

Set the constant that determines the change in feedrate as the manual pulse generator is rotated one graduation during F1-digit feed.

$$\Delta F = \frac{F_{\max i}}{100n} \quad (\text{where, } i=1 \text{ or } 2)$$

In the above equation, set n. That is, the number of revolutions of the manual pulse generator, required to reach feedrate $F_{\max i}$ is obtained. $F_{\max i}$ refers to the upper limit of the feedrate for an F1-digit feed command, and set it in parameter 1460 or 1461.

$F_{\max 1}$: Upper limit of the feedrate for F1 to F4 (parameter 1460)

$F_{\max 2}$: Upper limit of the feedrate for F5 to F9 (parameter 1461)

1451	Feedrate for F1 digit command F1
1452	Feedrate for F1 digit command F2
1453	Feedrate for F1 digit command F3
1454	Feedrate for F1 digit command F4
1455	Feedrate for F1 digit command F5
1456	Feedrate for F1 digit command F6
1457	Feedrate for F1 digit command F7
1458	Feedrate for F1 digit command F8
1459	Feedrate for F1 digit command F9

Input for setting is enabled.

[Data type] 2-word

[Unit of data]

[Valid data range]

Increment system	Unit of data	Valid data range	
		IS-A, IS-B	IS-C
Millimeter machine	1 mm/min	6 – 150000	6 – 120000
Inch machine	0.1 inch/min	6 – 6000	0 – 48000
Rotaion axis	1 deg/min	6 – 150000	0 – 120000

Set Feedrates for one-digit F code feed commands F1 to F9.

When an one-digit F code feed command is executed, as the feedrate is changed by turning the manual pulse generator, these parameter values also change accordingly.

1460	Upper limit of feedrate for the one-digit F code command (F1 to F4)
1461	Upper limit of feedrate for the one-digit F code command (F5 to F9)

[Data type] 2-word

[Unit of data]

[Valid data range]

Increment system	Unit of data	Valid data range	
		IS-A, IS-B	IS-C
Millimeter machine	1 mm/min	6 – 15000	6 – 12000
Inch machine	0.1 inch/min	6 – 6000	6 – 4800
Rotaion axis	1 deg/min	6 – 15000	6 – 12000

Set the upper limit of feedrate for the F1-digit feed command.

As the feedrate increases by turning the manual pulse generator, the feedrate is clamped when it reaches the upper limit set. If an F1-digit feed command F1 to F4 is executed, the upper limit is that set in parameter 1460. If an F1-digit command F5 to F9 is executed, the upper limit is that set in parameter 1461.

4.8 PARAMETERS OF ACCELERATION/ DECELERATION CONTROL

	#7	#6	#5	#4	#3	#2	#1	#0
1601		ACD	NCI	RTO				
		ACD	NCI	RTO		OVB		

[Data type] Bit

- OVB** Block overlap in cutting feed
 0: Blocks are not overlapped in cutting feed.
 1: Blocks are overlapped in cutting feed.

Block overlap outputs the pulses remaining at the end of pulse distribution in a block together with distribution pulses in the next block. This eliminates changes in feedrates between blocks.

Block overlap is enabled when blocks containing G01, G02, or G03 are consecutively specified in G64 mode. If minute blocks, however, are specified consecutively, overlap may not be performed.

The following pulses in block F2 are added to the pulses remaining at the end of pulse distribution in block F1.

$$(\text{Number of pulses to be added}) = F2 \times \frac{(\text{Number of pulses required at the end of block F1})}{F1}$$

When F1 = F2

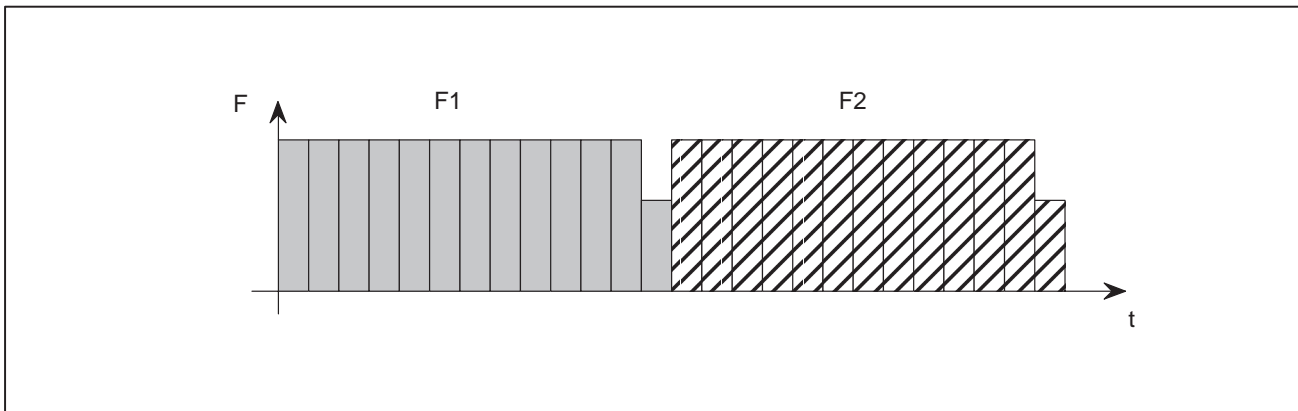

When block overlap is disabled

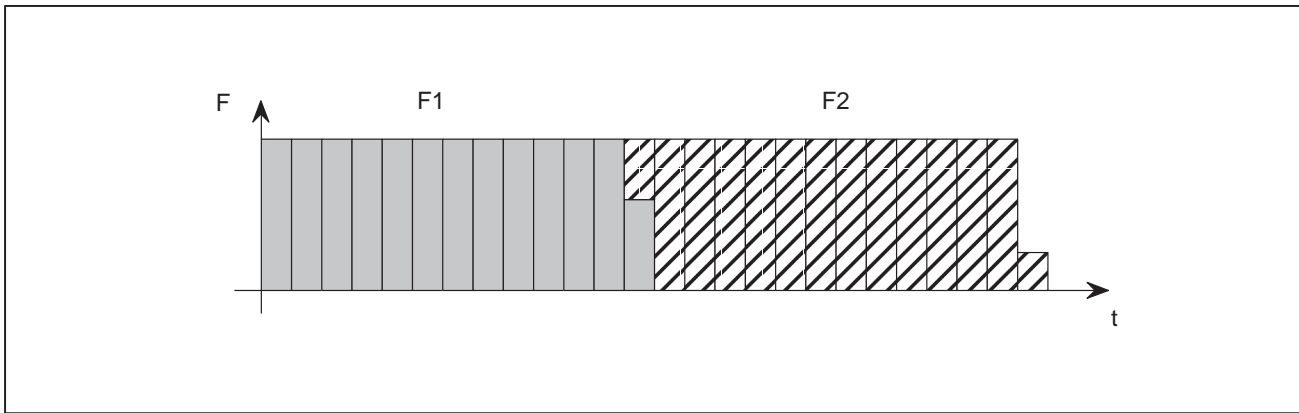

When block overlap is enabled

- RTO** Block overlap in rapid traverse
 0 : Blocks are not overlapped in rapid traverse.
 1 : Blocks are overlapped in rapid traverse.

Note

See the description of parameter No. 1722.

- NCI** Inposition check at deceleration
 0 : Performed
 1 : Not performed
- ACD** Function for automatically reducing the feedrate at corners (automatic corner override function)
 0 : The function is not used.
 1 : The function is used.

	#7	#6	#5	#4	#3	#2	#1	#0
1602		LS2		CSD				FWB

[Data type] Bit

- FWB** Cutting feed acceleration/deceleration before interpolation
 0 : Type A of acceleration/deceleration before interpolation is used.
 1 : Type B of acceleration/deceleration before interpolation is used.
- Type A: When a feedrate is to be changed by a command, acceleration/deceleration starts after the program enters the block in which the command is specified.
- Type B: When a feedrate is to be changed by a command, deceleration starts and terminates at the block before the block in which the command is specified.
 When a feedrate is to be changed by a command, acceleration starts after the program enters the block in which the command is specified.

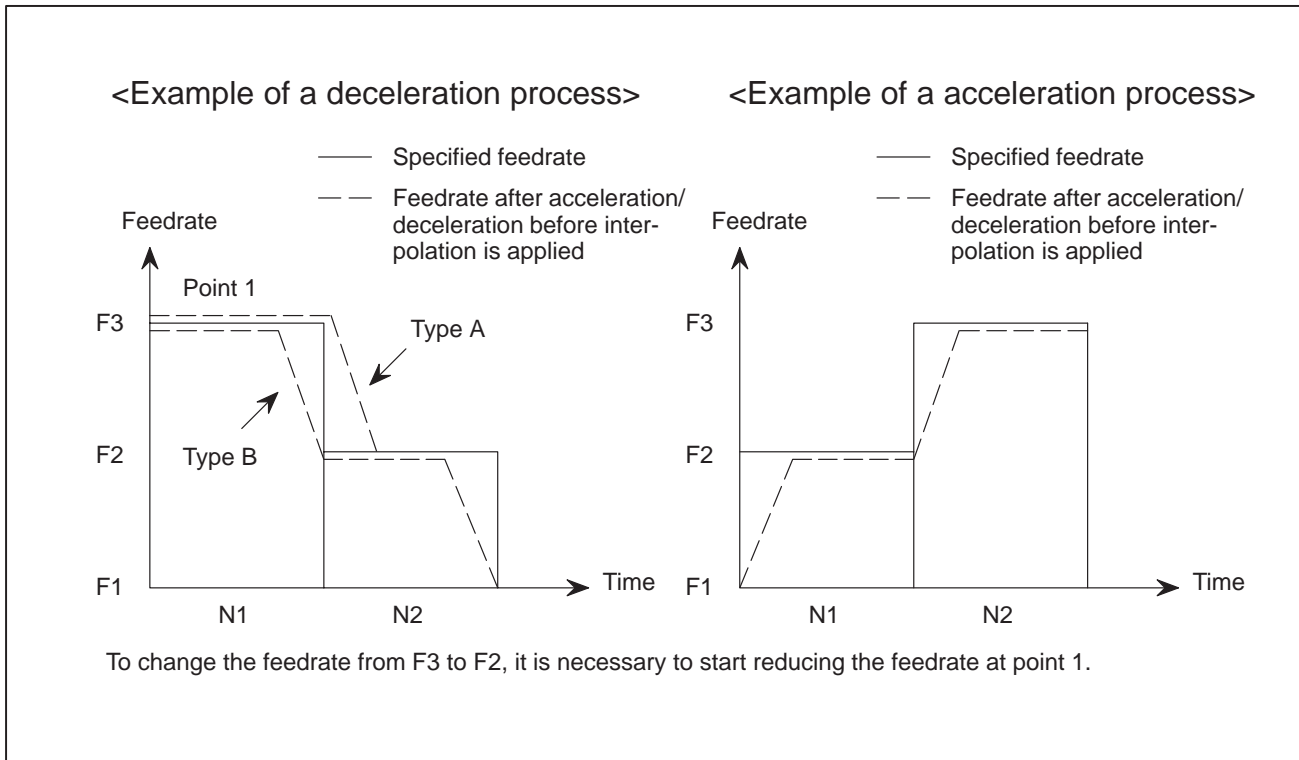

CSD In the function for automatically reducing a feedrate at corners,
 0 : Angles are used for controlling the feedrate.
 1 : Differences in feedrates are used for controlling the feedrate.

LS2 Acceleration/deceleration after interpolation for cutting feed in the look-ahead control mode is:
 0 : Exponential acceleration/deceleration
 1 : Linear acceleration/deceleration. (The function for linear acceleration/deceleration after interpolation for cutting feed is required.)

	#7	#6	#5	#4	#3	#2	#1	#0
1610				JGLx			CTBx	CTLx

[Data type] Bit axis

CTLx Acceleration/deceleration in cutting feed including feed in dry run
 0 : Exponential acceleration/deceleration is applied.
 1 : Linear acceleration/deceleration after interpolation is applied.

Note

If the optional function of linear acceleration/deceleration after interpolation in cutting feed is not provided, exponential acceleration/deceleration is used irrespective of this setting.

To use bell-shaped acceleration/deceleration after interpolation, set this parameter to 0 and select the acceleration/deceleration using CTBx, bit 1 of parameter No. 1610.

Parameter		Acceleration/deceleration
CTBx	CTLx	
0	0	Exponential acceleration/deceleration
0	1	Linear acceleration/deceleration after interpolation
1	0	Bell-shaped acceleration/deceleration after interpolation

- CTBx** Acceleration/deceleration in cutting feed including feed in dry run
 0 : Exponential acceleration/deceleration or linear acceleration/deceleration after interpolation is applied (depending on the setting in CTLx, bit 0 of parameter No. 1610).
 1 : Bell-shaped acceleration/deceleration after interpolation is applied.

Note

This parameter is effective only when the function of bell-shaped acceleration/deceleration after interpolation in cutting feed is provided. If the function is not provided, the setting in CTLx, bit 0 of parameter No. 1610, determines the type of acceleration/deceleration irrespective of the setting in this parameter.

- JGLx** Acceleration/deceleration in jog feed
 0 : Exponential acceleration/deceleration is applied.
 1 : Linear acceleration/deceleration after interpolation or bell-shaped acceleration/deceleration after interpolation is applied (depending on which is used for cutting feed).

1620

Time constant used for linear acceleration/deceleration or bell-shaped acceleration/deceleration in rapid traverse for each axis

[Data type] Word axis

[Unit of data] ms

[Valid data range] 0 to 4000

Specify a time constant used for acceleration/deceleration in rapid traverse. When the optional function of bell-shaped acceleration/deceleration in rapid traverse is provided, bell-shaped acceleration/deceleration is applied in rapid traverse. If the function is not provided, linear acceleration/deceleration is applied.

- (1) When the function is provided, set this parameter to time constant T1 used in bell-shaped acceleration/deceleration in rapid traverse, and set parameter No. 1621 to time constant T2.
- (2) When the function is not provided, specify a time constant used in linear acceleration/deceleration.

Note

When parameter No. 1621 (time constant T2 used for bell-shaped acceleration/deceleration in rapid traverse) is set to 0, linear acceleration/deceleration is applied in rapid traverse even if the function is provided. In this case, this parameter stands for a time constant used in linear acceleration/deceleration in rapid traverse.

<Rapid traverse linear acceleration/deceleration>

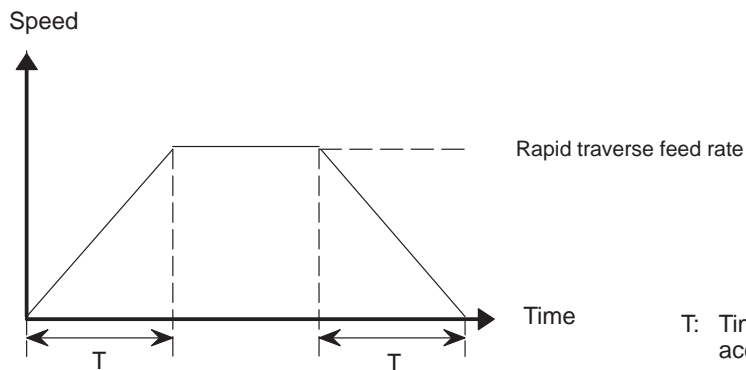

T: Time constant for linear acceleration/deceleration

<Rapid traverse bell shaped acceleration/deceleration>

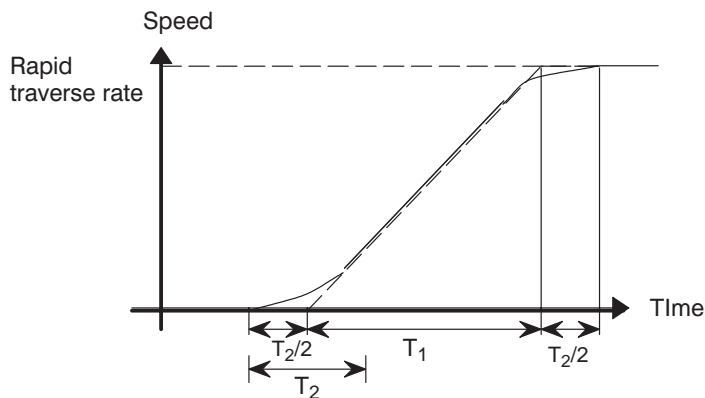

T_1 : Set a time constant used for linear acceleration/deceleration

T_2 : Set a time for rounding.

Total time= $T_1 + T_2$

Time for linear= $T_1 - T_2$

Time for rounding part= T_2

Set the value when the rapid traverse rate is 100%. If it is under 100%, the total time is reduced. (Constant acceleration method)

The value of T_1 is determined from the torque of motor. Usually set the value of T_2 to 24 ms or 32 ms.

1621

Time constant t T2 used for bell-shaped acceleration/deceleration in rapid traverse for each axis

[Data type] Word axis

[Unit of data] ms

[Valid data range] 0 to 512

Specify time constant T2 used for bell-shaped acceleration/deceleration in rapid traverse for each axis.

Notes

- 1 This parameter is effective when the function of bell-shaped acceleration/deceleration in rapid traverse is provided. Set parameter No. 1620 to time constant T1 used for bell-shaped acceleration/deceleration in rapid traverse, and set this parameter to time constant T2. For details of time constants T1 and T2, see the description of parameter No.1620.
- 2 When this parameter is set to 0, linear acceleration/deceleration is applied in rapid traverse. The setting in parameter No. 1620 is used as a time constant in linear acceleration/deceleration.

1622

Time constant of exponential acceleration/deceleration or bell-shaped acceleration/deceleration after interpolation, or linear acceleration/deceleration after interpolation in cutting feed for each axis

[Data type] Word axis

[Unit of data] ms

[Valid data range] 0 to 4000(exponential acceleration/deceleration in cutting feed)
0 to 512 (linear or bell-shaped acceleration/deceleration after interpolation in cutting feed)

Set the time constant used for exponential acceleration/deceleration in cutting feed, bell-shaped acceleration/deceleration after interpolation or linear acceleration/deceleration after interpolation in cutting feed for each axis. Except for special applications, the same time constant must be set for all axes in this parameter. If the time constants set for the axes differ from each other, proper straight lines and arcs cannot be obtained.

Bell-shaped acceleration/deceleration after cutting feed interpolation

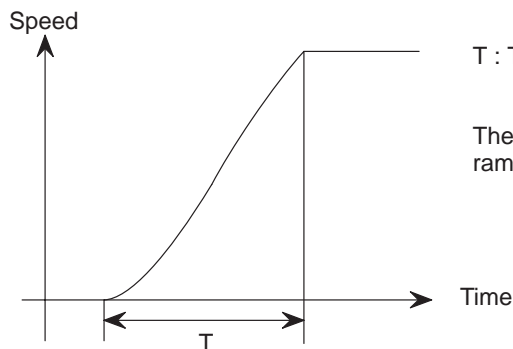

T : Total time. it is constant irrespective of feed rate.
(Time constant is constant).

The curve corresponds to that T1 = T/2 and T2 = T/2 set in parameter no. 1620 and 1621.

1623

FL rate of exponential acceleration/deceleration in cutting feed for each axis

[Data type] Word axis**[Unit of data]****[Valid data range]**

Increment system	Unit of data	Valid data range	
		IS-A, IS-B	IS-C
Millimeter machine	1 mm/min	6 – 15000	6 – 12000
Inch machine	0.1 inch/min	6 – 6000	6 – 4800
Rotation axis	1 deg/min	6 – 15000	6 – 12000

Set the lower limit (FL rate) of exponential acceleration/deceleration in cutting feed for each axis. Except for special applications, this parameter must be set to 0 for all axes. If a value other than 0 is specified, proper straight lines and arcs cannot be obtained.

1624

Time constant of exponential acceleration/deceleration or bell-shaped acceleration/deceleration or linear acceleration/deceleration after interpolation, in jog feed for each axis.

[Data type] Word axis**[Unit of data]** ms

[Valid data range] 0 to 4000(exponential acceleration/deceleration in jog feed)
0 to 512 (linear or bell-shaped acceleration/deceleration after interpolation in jog feed)

Set the time constant used for exponential acceleration/deceleration, bell-shaped acceleration/deceleration or linear acceleration/deceleration after interpolation in jog feed for each axis.

1625

FL rate of exponential acceleration/deceleration in jog feed for each axis.

[Data type] Word axis**[Unit of data]****[Valid data range]**

Increment system	Unit of data	Valid data range	
		IS-A, IS-B	IS-C
Millimeter machine	1 mm/min	6 – 15000	6 – 12000
Inch machine	0.1 inch/min	6 – 6000	6 – 4800
Rotation axis	1 deg/min	6 – 15000	6 – 12000

Set the lower limit (FL rate) of exponential acceleration/deceleration in cutting feed for each axis.

1626	Time constant of exponential acceleration/deceleration in the thread cutting cycle for each axis

[Data type] Word

[Unit of data] ms

[Valid data range] 0 to 4000

Set the time constant used for exponential acceleration/deceleration in the thread cutting cycle (G76, G78 (G92 in G code system A)) for each axis.

1627	FL rate of exponential acceleration /deceleration in the thread cutting cycle for each axis

[Data type] Word axis

[Unit of data]

[Valid data range]

Increment system	Unit of data	Valid data range	
		IS-A, IS-B	IS-C
Millimeter machine	1 mm/min	6 – 15000	6 – 12000
Inch machine	0.1 inch/min	6 – 6000	6 – 4800
Rotation axis	1 deg/min	6 – 15000	6 – 12000

Set the lower limit (FL rate) of exponential acceleration/deceleration in the thread cutting cycle (G76, G78 (G92 in G code system A)) for each axis.

1630	Parameter 1 for setting an acceleration for linear acceleration/deceleration before interpolation (maximum machining feedrate during linear acceleration/deceleration before interpolation)
------	---------------------------------------------------------------------------------------------------------------------------------------------------------------------------------------------

[Data type] 2-word

Increment system	Unit of data	Valid data range	
		IS-A, IS-B	IS-C
Millimeter machine	1 mm/min	6 – 240000	6 – 100000
Inch machine	0.1 inch/min	6 – 96000	6 – 48000

This parameter is used to set an acceleration for linear acceleration/deceleration before interpolation. In this parameter, set a maximum machining speed during linear acceleration/deceleration before interpolation. In parameter No. 1631, set a time used to reach the maximum machining speed.

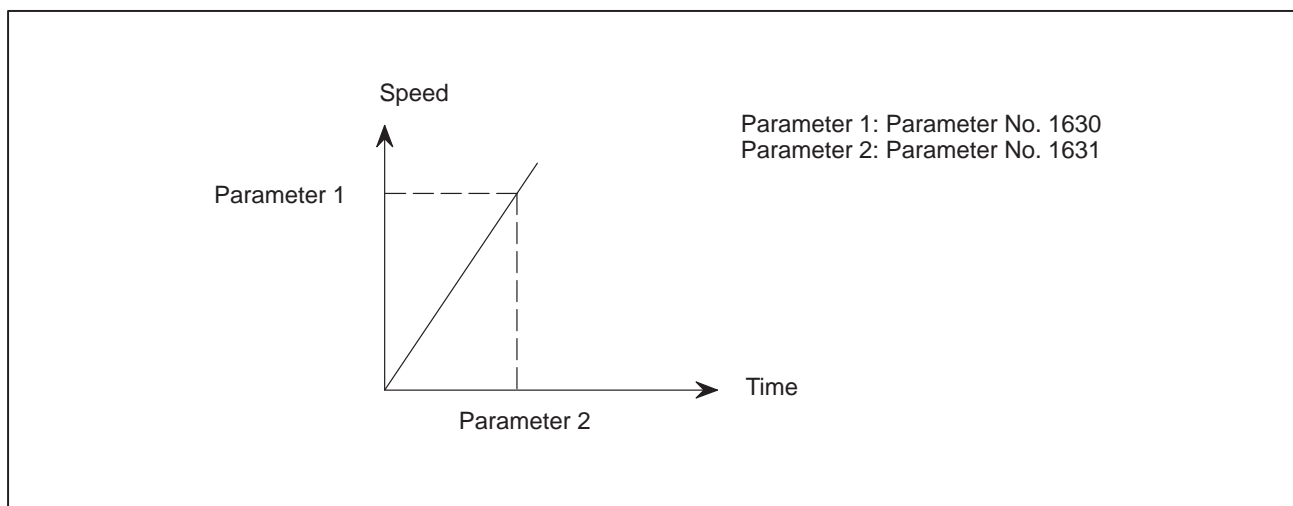
**Notes**

- 1 When 0 is set in parameter No. 1630 or parameter No. 1631, linear acceleration/deceleration before interpolation is disabled.
- 2 In the look-ahead control mode, parameter No. 1770 and parameter No. 1771 are valid.

1631

Parameter 2 for setting an acceleration for linear acceleration/deceleration before interpolation (time used to reach the maximum machining speed during linear acceleration/deceleration before interpolation.)

[Data type] Word

[Unit of data] 1 ms

[Valid data range] 0 to 4000

This parameter is used to set an acceleration for linear acceleration/deceleration before interpolation. In this parameter, set the time (time constant) used to reach the speed set in parameter No. 1630.

Notes

- 1 When 0 is set in parameter No. 1630 or parameter No. 1631, linear acceleration/deceleration before interpolation is disabled.
- 2 In parameter Nos. 1630 and 1631, set values that satisfy the following:
Parameter No. 1630/Parameter No. 1631 > 5
- 3 In the look-ahead control mode, parameter No. 1770 and parameter No. 1771 are valid.

1710	
	Minimum deceleration ratio (MDR) of the inner circular cutting rate in automatic corner override

[Data type] Byte

[Unit of data] %

[Valid data range] 1 to 100

Set the minimum deceleration ratio (MDR) in changing the inner circular cutting feed rate by automatic corner override.

In circular cutting with an inward offset, the actual feedrate for a specified feedrate (F) becomes as follows:

$$F \times \frac{R_c}{R_p} \left(\begin{array}{l} \mathbf{R_c: Radius of the path of the cutter's center} \\ \mathbf{R_p: Programmed radius} \end{array} \right)$$

By the actual feedrate becomes the value obtained from the above equation, the specified rate F can be achieved on the program path.

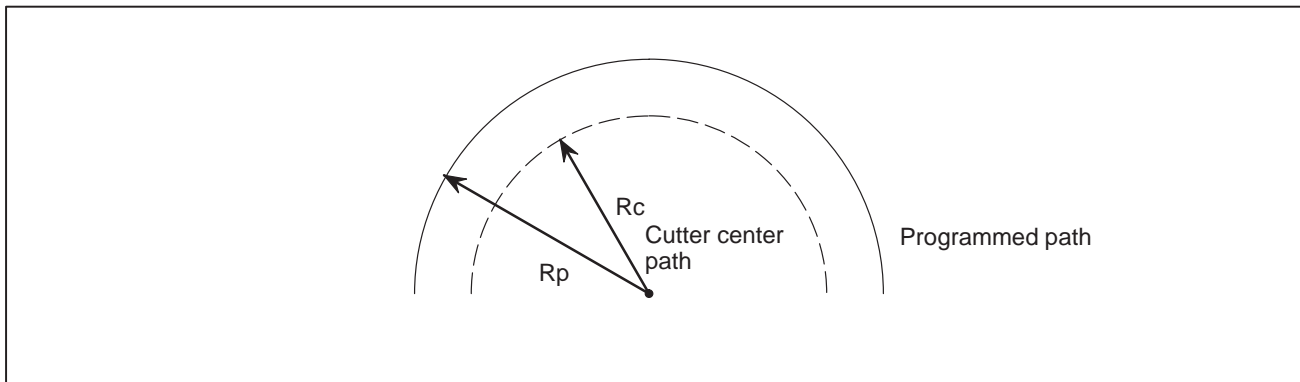

Fig. 4.8 (a) Rp and Rc

If R_c is too small in comparison with R_p so that $\frac{R_c}{R_p} \cong 0$, the cutter will stop. To prevent this, the minimum deceleration ratio (MDR) is set.

When $\frac{R_c}{R_p} \cong 0$,

The actual rate becomes as follows:

$$F \times (\mathbf{MDR})$$

1711	
	Angle (θ_p) to recognize the inner corner in automatic override

[Data type] Byte

[Unit of data] Degree

[Valid data range] 1 to 179 (standard value = 91)

Set the angle to recognize the inner corner when automatic override is performed for the inner corner.

1712	
	Amount of automatic override for an inner corner

[Data type] Byte

[Unit of data] %

[Valid data range] 1 to 100 (standard value = 50)

Set the amount of automatic override for an inner corner.

1713	
	Distance Le from the starting point in inner corner automatic override

[Data type] Word

[Unit of data]

Increment system	IS-A	IS-B	IS-C	Unit
Input in mm	1	0.1	0.01	mm
Input in inches	0.1	0.01	0.001	inch

[Valid data range] 0 to 3999

Set distance Le from the starting point in an inner corner for automatic corner override.

1714	Distance Ls up to the ending point in inner corner automatic override
------	-----------------------------------------------------------------------

[Data type] Word

[Unit of data]

Increment system	IS-A	IS-B	IS-C	Unit
Input in mm	1	0.1	0.01	mm
Input in inches	0.1	0.01	0.001	inch

[Valid data range] 0 to 3999

Set distance Ls up to the end point in an inner corner for automatic corner override.

If $\theta \leq \theta_p$, the inside of a corner is recognized. (θ is set in parameter 1711.)

When an inner corner is recognized, the feedrate is overridden in the range of Le in the block immediately before the intersection of the corner and Ls in the next block following the intersection.

Ls and Le are each a straight line connecting the intersection of the corner and a given point on the path of the cutter's center.

Ls and Le are set in parameters 1713 and 1714.

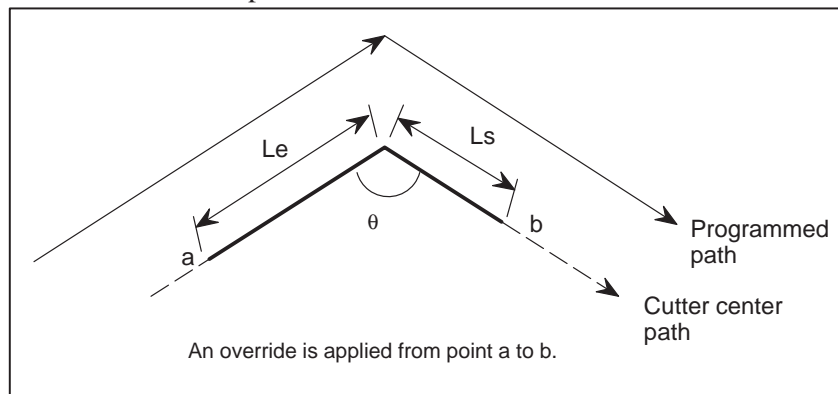

Fig.4.8 (c) Distance Le and Ls in the automatic corner override at an inner corner

1722	Rapid traverse feedrate reduction ratio for overlapping rapid traverse blocks
------	-------------------------------------------------------------------------------

[Data type] Byte axis

[Unit of data] %

[Valid data range] 1 to 100

This parameter is used when rapid traverse blocks are arranged successively, or when a rapid traverse block is followed by a block that does not cause, movement. When the feedrate for each axis of a block is reduced to the ratio set in this parameter, the execution of the next block is started.

Examples

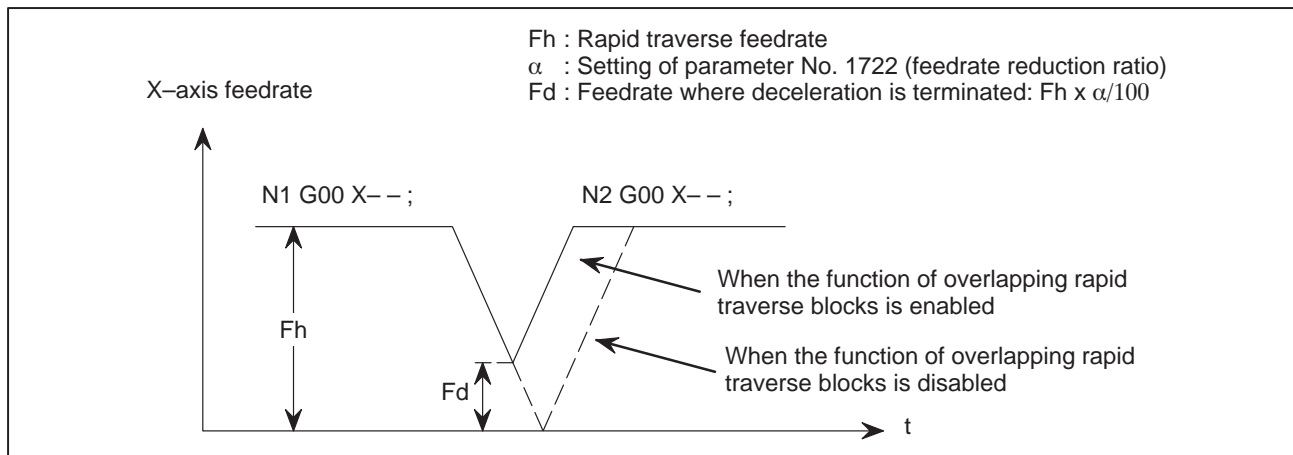

Note
 The parameter No. 1722 is effective when parameter No. 1601 #4 (RT0) is set to 1.

1730

Maximum feedrate for arc radius R

[Data type] Word**[Unit of data]**

Increment system	Unit of data	Valid data range	
		IS-A, IS-B	IS-C
Millimeter machine	1 mm/min	8 – 15000	0 – 12000
Inch machine	0.1 inch/min	8 – 6000	0 – 4800

Set a maximum feedrate for the arc radius set in parameter No. 1731. Set this parameter when the arc radius-based feedrate clamping function is enabled.

1731

Arc radius value corresponding to a maximum feedrate

[Data type] 2-word**[Unit of data]**

Unit	IS-A	IS-B	IS-C	Unit
Linear axis (millimeter machine)	0.01	0.001	0.0001	mm
Linear axis (inch machine)	0.001	0.0001	0.00001	inch

[Valid data range] 1000 to 99999999

Set the arc radius corresponding to the maximum feedrate set in parameter No. 1730. Set this parameter when the arc radius-based feedrate clamping function is enabled.

1732

Minimum value (RV min) for arc radius-based feedrate clamp

[Data type] Word

Increment system	Unit of data	Valid data range	
		IS-A, IS-B	IS-C
Millimeter machine	1 mm/min	0 – 15000	0 – 12000
Inch machine	0.1 inch/min	0 – 6000	0 – 4800

The arc radius-based feedrate clamping function reduces the maximum feedrate as the arc radius decreases. When the specified maximum feedrate is not greater than RV min (minimum value for arc radius-based feedrate clamping), RV min is used as the maximum feedrate.

1740

Critical angle subtended by two blocks for automatic corner deceleration

[Data type] 2-word**[Unit of data]** 0.001 deg**[Valid data range]** 0 to 180000

Set a critical angle to be subtended by two blocks for corner deceleration when the angle-based automatic corner deceleration function is used.

The angle subtended by two blocks is defined as θ in the examples shown below.

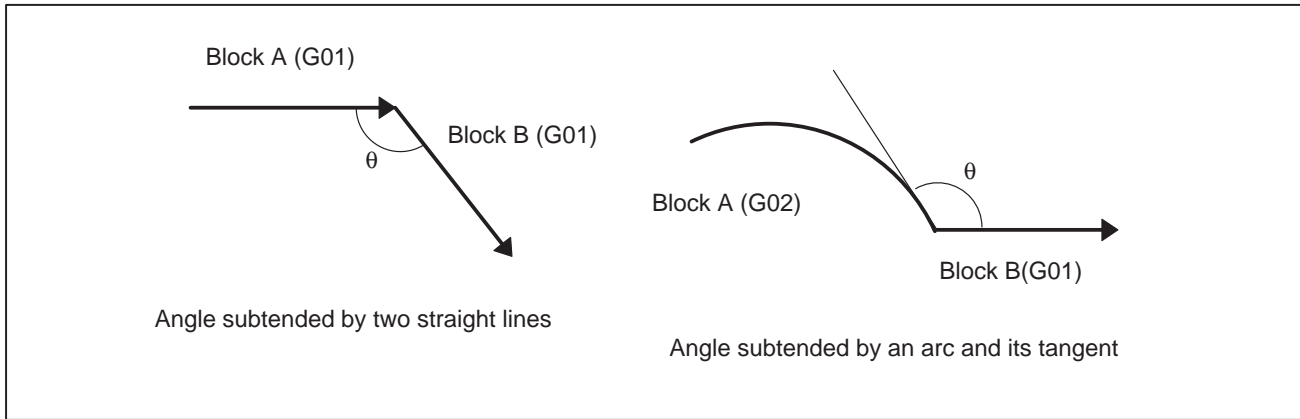

1741	Feedrate for assuming the termination of automatic corner deceleration (for acceleration/deceleration after interpolation)
------	----------------------------------------------------------------------------------------------------------------------------

[Data type] Word axis

[Unit of data]

Increment system	Unit of data	Valid data range	
		IS-A, IS-B	IS-C
Millimeter machine	1 mm/min	6 – 15000	6 – 12000
Inch machine	0.1 inch/min	6 – 6000	6 – 4800
Rotation axis	1 deg/min	6 – 15000	6 – 12000

Set the feedrate for assuming the termination of deceleration in automatic corner deceleration.

1762	Exponential acceleration/deceleration time constant for cutting feed in the look-ahead control mode
------	-----------------------------------------------------------------------------------------------------

[Data type] Word axis

[Unit of data] 1 ms

[Valid data range] 0 to 4000

Set an exponential acceleration/deceleration time constant for cutting feed in the look-ahead control mode.

1763	Minimum speed in exponential acceleration/deceleration for cutting feed in the look-ahead control mode
------	--------------------------------------------------------------------------------------------------------

[Data type] Word axis

Increment system	Unit of data	Valid data range	
		IS-A, IS-B	IS-C
Millimeter machine	1 mm/min	6 – 15000	6 – 12000
Inch machine	0.1 inch/min	6 – 6000	6 – 4800
Rotation axis	1 deg/min	6 – 15000	6 – 12000

Set minimum speed (FL) in exponential acceleration/deceleration for cutting feed in the look-ahead control mode.

1768	Time constant for linear acceleration/deceleration during cutting feed in lock-ahead control mode.
------	----------------------------------------------------------------------------------------------------

[Data type] Word axis

[Unit of data] ms

[Valid data range] 8 to 512

This parameter sets a time constant for linear acceleration/deceleration for cutting feed in the look-ahead control mode.

Note
The function for linear acceleration/deceleration after interpolation for cutting feed is required.

1770	Parameter 1 (for look-ahead control) for setting an acceleration for linear acceleration/deceleration before interpolation (maximum machining speed during linear acceleration/deceleration before interpolation)
------	-------------------------------------------------------------------------------------------------------------------------------------------------------------------------------------------------------------------

[Data type] 2-word

[Unit of data, valid range]

Increment system	Unit of data	Valid data range	
		IS-A, IS-B	IS-C
Millimeter machine	1 mm/min	6 - 240000	6 - 100000
Inch machine	0.1 inch/min	6 - 96000	6 - 48000

This parameter is used to set an acceleration for linear acceleration/deceleration before interpolation in the look-ahead control mode. In this parameter, set the maximum machining speed during linear acceleration/deceleration before interpolation. Set the time used to reach the maximum machining speed in parameter No.1771.

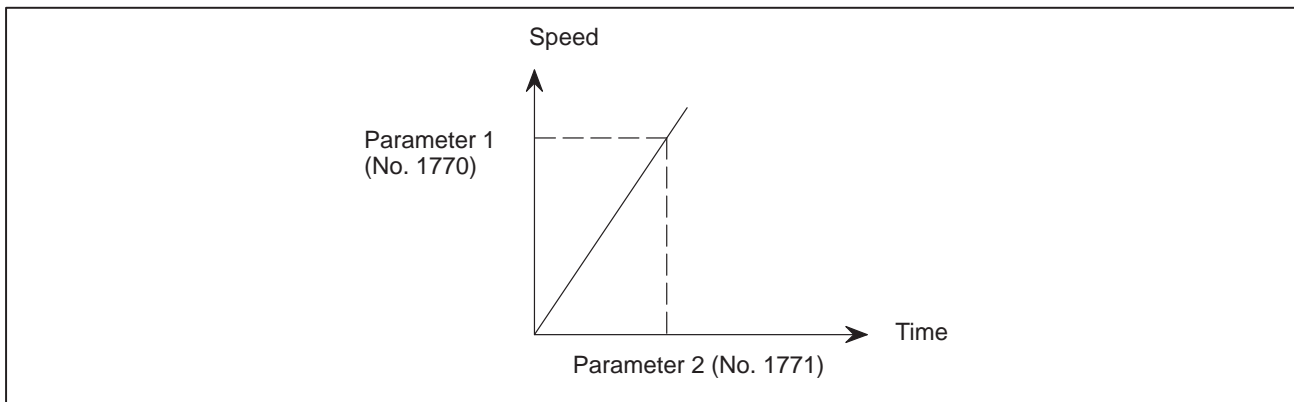

Note
When 0 is set in parameter No. 1770 or parameter No. 1771, linear acceleration/deceleration before interpolation is disabled.

1771

Parameter 2 (for look-ahead control) for setting an acceleration for linear acceleration/deceleration before interpolation (time used to reach the maximum machining speed during linear acceleration/deceleration before interpolation)

[Data type] Word

[Unit of data] 1 msec

[Valid range] 0 to 4000

This parameter is used to set an acceleration for linear acceleration/deceleration before interpolation in the look-ahead control mode. In this parameter, set the time (time constant) used to reach the speed set in parameter No. 1770.

Notes

- 1 When 0 is set in parameter No. 1770 or parameter No. 1771, linear acceleration/deceleration before interpolation is disabled.
- 2 In parameter Nos. 1770 and 1771, set values that satisfy the following:
Parameter No. 1770/Parameter No. 1771 ≥ 5

1775

(Must not be used)

1776

(Must not be used)

1777

Minimum speed for the automatic corner deceleration function (look-ahead control)

[Data type] Word axis

[Unit of data, valid range]

Increment system	Unit of data	Valid data range	
		IS-A, IS-B	IS-C
Millimeter machine	1 mm/min	6 – 15000	6 – 12000
Inch machine	0.1 inch/min	6 – 6000	6 – 4800
Rotation axis	1 deg/min	6 – 15000	6 – 12000

Set a speed at which the number of buffered pulses in deceleration is assumed to be 0 when linear acceleration/deceleration before interpolation is used.

1778

Minimum speed of for the automatic corner deceleration function (for linear acceleration/deceleration before interpolation)

[Data type] Word axis

[Unit of data, valid range]

Increment system	Unit of data	Valid data range	
		IS-A, IS-B	IS-C
Millimeter machine	1 mm/min	6 – 15000	6 – 12000
Inch machine	0.1 inch/min	6 – 6000	6 – 4800
Rotation axis	1 deg/min	6 – 15000	6 – 12000

Set a speed at which the number of buffered pulses in deceleration is assumed to be 0 when linear acceleration/deceleration before interpolation is used.

1779

Critical angle subtended by two blocks for automatic corner deceleration (for look-ahead control)

[Data type] 2-word

[Unit of data] 0.001 deg

[Valid data range] 0 to 180000

Set a critical angle to be subtended by two blocks for corner deceleration when the angle-based automatic corner deceleration function is used.

The angle subtended by two blocks is defined as θ in the examples shown below.

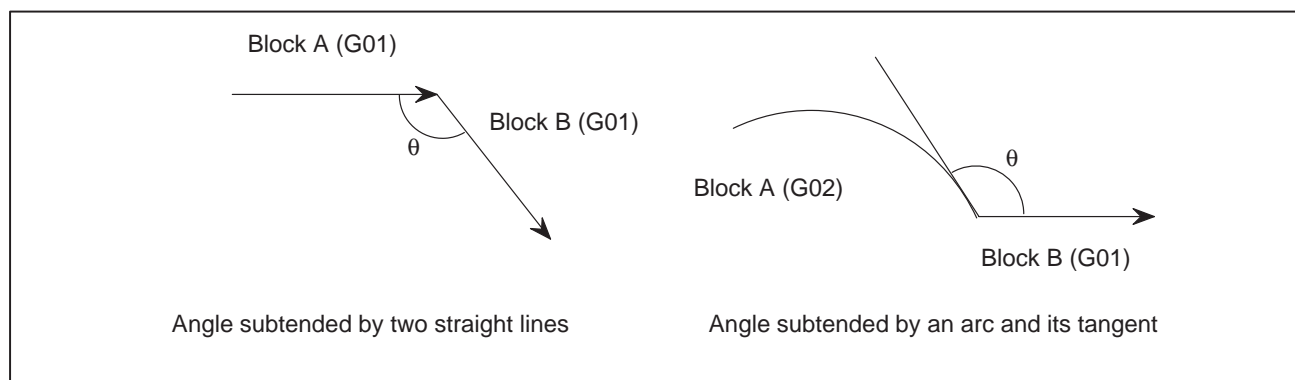

1780

Allowable speed difference for the speed difference-based corner deceleration function (for linear acceleration/deceleration before interpolation)

[Data type] Word

[Unit of data, valid range]

Increment system	Unit of data	Valid range	
		IS-A, IS-B	IS-C
Millimeter machine	1 mm/min	6 – 15000	6 – 12000
Inch machine	0.1 inch/min	6 – 6000	6 – 4800

Set the speed difference for the speed difference-based automatic corner deceleration function when linear acceleration/deceleration before interpolation is used.

[Data type] Word axis

[Unit of data, valid range]

Increment system	Unit of data	Valid range	
		IS-A, IS-B	IS-C
Millimeter machine	1 mm/min	6 – 15000	6 – 12000
Inch machine	0.1 inch/min	6 – 6000	6 – 4800
Rotation axis	0.1 deg/min	6 – 15000	6 – 12000

1781

Allowable speed difference for the speed difference–based corner deceleration function (linear acceleration/deceleration after interpolation)

Set speed difference for the speed difference–based automatic corner deceleration function when linear acceleration/deceleration after interpolation used.

1783

Allowable speed difference for the speed difference based corner deceleration function (linear acceleration/deceleration before interpolation)

[Data type] Word axis

[Unit of data, valid range]

Increment system	Unit of data	Valid range	
		IS–A, IS–B	IS–C
Millimeter machine	1 mm/min	6 – 15000	6 – 12000
Inch machine	0.1 inch/min	6 – 6000	6 – 4800
Rotation axis	0.1 deg/min	6 – 15000	6 – 12000

A separate allowable feedrate difference can be set for each axis. The allowable feedrate difference is set for each axis with this parameter. Among the axes that exceed the specified allowable feedrate difference, the axis with the greatest ratio of the actual feedrate difference to the allowable feedrate difference is used as the reference to calculate the reduced feedrate at the corner.

1784

Speed when overtravel alarm has generated during acceleration/deceleration before interpolation

[Data type] Word axis

[Unit of data]

[Valid data range]

Increment system	Unit of data	Valid range	
		IS–A, IS–B	IS–C
Millimeter machine	1 mm/min	6 – 15000	6 – 12000
Inch machine	0.1 inch/min	6 – 6000	6 – 4800

Deceleration is started beforehand to reach the feedrate set in the parameter when an overtravel alarm is issued (when a limit is reached) during linear acceleration/deceleration before interpolation. By using this parameter, the overrun distance that occurs when an overtravel alarm is output can be reduced.

Notes

- 1 When 0 is set in this parameter, the control described above is not exercised.
- 2 Use type–B linear acceleration/deceleration before interpolation (by setting bit 0 (FWB) of parameter No. 1602 to 1).
- 3 The control described above is applicable only to stored stroke limit 1.

4.9 PARAMETERS OF SERVO

	#7	#6	#5	#4	#3	#2	#1	#0
1800			TRC	RBK	FFR	OZR	CVR	

[Data type] Bit

CVR When velocity control ready signal VRDY is set ON before position control ready signal PRDY comes ON

0: A servo alarm is generated.

1: A servo alarm is not generated.

OZR When manual reference position return is attempted in the halt state during automatic operation (feed hold stop state) under any of the conditions listed below:

0: Manual reference position return is not performed, with P/S alarm No. 091.

1: Manual reference position return is performed without an alarm occurring.

< Conditions >

(1) When there is a remaining distance to travel.

(2) When an auxiliary function (miscellaneous function, spindle-speed function, tool function) is being executed.

(3) When a cycle such as a dwell cycle or canned cycle is being executed.

FFR Feed-forward control is enabled for

0: Cutting feed only

1: Cutting feed and rapid traverse

RBK Backlash compensation applied separately for cutting feed and rapid traverse

0: Not performed

1: Performed

TRC The servo trace function is:

0: Disabled

1: Enabled (Also set parameter No. 1870.)

	#7	#6	#5	#4	#3	#2	#1	#0
1801			CIN	CCI			PM2	PM1
			CIN	CCI				

[Data type] Bit

PM1, PM2 Sets a gear ratio between the spindle and motor when the servo motor-based speed control function is used.

Magnification	PM2	PM1
1/1	0	0
1/2	0	1
1/4	1	0
1/8	1	1

$$\text{Magnification} = \frac{\text{spindle speed}}{\text{motor speed}}$$

- CCI** The in-position area for cutting feed is:
 0 : Set in parameter No. 1826 (same as for rapid traverse).
 1 : Set in bit 5 (CIN) of parameter No. 1801.
- CIN** When bit 4 (CCI) of parameter No. 1801 = 1, the in-position area for cutting feed is:
 0 : Use value in parameter No. 1827 if the next block is also for cutting feed, or use value in parameter No. 1826 if the next block is not for cutting feed.
 1 : Use value in parameter No. 1827, regardless of the next block. (The setting of parameter No. 1826 is used for rapid traverse, and the setting of parameter No. 1827 is used for cutting feed.)

	#7	#6	#5	#4	#3	#2	#1	#0
1802			DPS					CTS

Note

After this parameter is set, the power needs to be turned off.

[Data type] Bit

- CTS** The servo motor-based speed control function is:
 0 : Not used
 1 : Used
- DPS** When servo motor-based speed control is applied, a position coder is:
 0 : Used
 1 : Not used

	#7	#6	#5	#4	#3	#2	#1	#0
1804		SAK						

[Data type] Bit axis

- SAK** When the VRDY OFF alarm ignore signal IGNVRY is 1, or when the VRDY OFF alarm ignore signals IGVRY1 to IGVRY8 are 1:
 0 : Servo ready signal SA is set to 0.
 1 : Servo ready signal SA remains set to 1.

	#7	#6	#5	#4	#3	#2	#1	#0
1815	ZMGx		APCx	APZx			OPTx	

Note

When this parameter has been set, the power must be turned off before operation is continued.

[Data type] Bit axis

- OPTx** Position detector

0 : A separate pulse coder is not used.

1 : A separate pulse coder is used.

APZx Machine position and position on absolute position detector when the absolute position detector is used

0 : Not corresponding

1 : Corresponding

Note

When an absolute position detector is used, after primary adjustment is performed or after the absolute position detector is replaced, this parameter must be set to 0, power must be turned off and on, then manual reference position return must be performed. This completes the positional correspondence between the machine position and the position on the absolute position detector, and sets this parameter to 1 automatically.

APCx Position detector

0 : Other than absolute position detector

1 : Absolute position detector (absolute pulse coder)

ZMGx Reference position return method is:

0 : Grid method

1 : Magne-switch method

	#7	#6	#5	#4	#3	#2	#1	#0
1816		DM3x	DM2x	DM1x				

Note

When this parameter has been set, the power must be turned off before operation is continued.

[Data type] Bit axis

DM1x to DM3x Setting of detection multiply

Set value			Detection multiply
DM3x	DM2x	DM1x	
0	0	0	1/2
0	0	1	1
0	1	0	3/2
0	1	1	2
1	0	0	5/2
1	0	1	3
1	1	0	7/2
1	1	1	4

Note

When the flexibly feed gear is used, do not use these parameters. Set the numerator and denominator of DMR to an appropriate values in parameters 2084 and 2085 respectively.

1817	#7	#6	#5	#4	#3	#2	#1	#0
		TAN						

Note

When this parameter has been set, the power must be turned off before operation is continued.

[Data type] Bit axis

TAN Tandem control
 0 : Not used
 1 : Used

Note

Set this parameter to both master axis and slave axis.

1819	#7	#6	#5	#4	#3	#2	#1	#0
								FUPx
	NAHx							FUPx

[Data type] Bit axis

FUPx To perform follow-up when the servo is off is set for each axis.
 0: The follow-up signal, *FLWU, determines whether follow-up is performed or not.
 When *FLWU is 0, follow-up is performed.
 When *FLWU is 1, follow-up is not performed.
 1: Follow-up is not performed.

Note

When the index table indexing function (M series) is used, be sure to set FUPx of the 4th axis to 1.

NAHx In the look-ahead control mode, advanced feed-forward is:
 0 : Used
 1 : Not used

Note

Set1 for a PMC-based control axis.

1820	Command multiply for each axis (CMR)
------	--------------------------------------

Note

When this parameter has been set, the power must be turned off before operation is continued.

[Data type] Byte axis

Set a command multiply indicating the ratio of the least command increment to the detection unit for each axis.

Least command increment = detection unit × command multiply

Relationship between the increment system and the least command increment

Increment system	Least command increment			Unit
	IS-A	IS-B	IS-C	
Millimeter machine	0.01	0.001	0.0001	mm
Inch machine	0.001	0.0001	0.00001	inch
Rotation axis	0.01	0.001	0.0001	deg

Setting command multiply (CMR), detection multiply (DMR), and the capacity of the reference counter

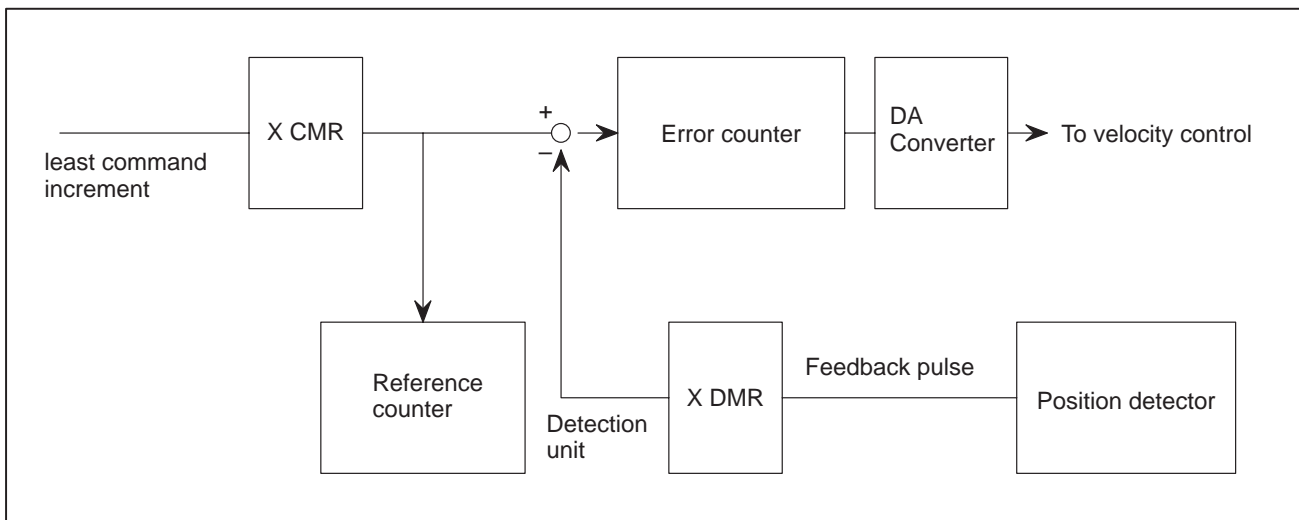

Fig.4.9 (a) CMR, DMR, and the Capacity of the Reference Counter

Set the magnification ratios of CMR and DMR so that the weight of positive inputs to the error counter equals that of negative inputs.

$$\frac{\text{Least command increment}}{\text{CMR}} = \text{detection unit} = \frac{\text{feedback pulse unit}}{\text{DMR}}$$

The feedback pulse unit varies according to the type of detector.

$$\text{Feedback pulse unit} = \frac{\text{the amount of travel per rotation of the pulse coder}}{\text{the number of pulses per rotation of the pulse coder (2000, 2500, or 3000)}}$$

As the size of the reference counter, specify the grid interval for the reference position return in the grid method.

Size of the reference counter = Grid interval/detection unit

Grid interval = the amount of travel per rotation of the pulse coder

The value set in the parameter is obtained as follows:

(1) When command multiply is 1/2 to 1/27

$$\text{Set value} = \frac{1}{(\text{Command multiply})} + 100$$

Valid data range: 102 to 127

- (2) When command multiply is 1 to 48
 Set value = 2 × command multiply
 Valid data range: 2 to 96

Note

When command multiply is 1 to 48, the set value must be determined so that an integer can be set for command multiply.

1821

Reference counter size for each axis

[Data type] 2–word type

[Valid data range] 0 to 99999999

Set the size of the reference counter.

Note

When this parameter has been set, the power must be turned off before operation is continued.

1825

Servo loop gain for each axis

[Data type] Word axis

[Unit of data] 0.01 s^{-1}

[Valid data range] 1 to 9999

Set the loop gain for position control for each axis.

When the machine performs linear and circular interpolation (cutting), the same value must be set for all axes. When the machine requires positioning only, the values set for the axes may differ from one another. As the loop gain increases, the response by position control is improved. A too large loop gain, however, makes the servo system unstable.

The relationship between the positioning deviation (the number of pulses counted by the error counter) and the feedrate is expressed as follows:

$$\text{Positioning deviation} = \frac{\text{feedrate}}{60} \times (\text{loop gain})$$

Unit: Positioning deviation mm, inches, or deg

Feedrate: mm/min, inches/min, or deg/min

loop gain: s^{-1}

1826

In–position width for each axis

[Data type] Word axis

[Unit of data] Detection unit

[Valid data range] 0 to 32767

The in–position width is set for each axis.

When the deviation of the machine position from the specified position (the absolute value of the positioning deviation) is smaller than the

in-position width, the machine is assumed to have reached the specified position. (The machine is in the in-position state.)

1827

In-position width in cutting feed for each axis

[Data type] Word axis

[Unit of data] Detection unit

[Valid data range] 0 to 32767

Set an in-position width for each axis in cutting feed. This parameter is valid when bit 4 (CCI) of parameter No. 1801=1.

1828

Positioning deviation limit for each axis in movement

[Data type] 2-word axis

[Unit of data] Detection unit

[Valid data range] 0 to 99999999

Set the positioning deviation limit in movement for each axis.

If the positioning deviation exceeds the positioning deviation limit during movement, a servo alarm is generated, and operation is stopped immediately (as in emergency stop).

Generally, set the positioning deviation for rapid traverse plus some margin in this parameter.

1829

Positioning deviation limit for each axis in the stopped state

[Data type] Word axis

[Unit of data] Detection unit

[Valid data range] 0 to 32767

Set the positioning deviation limit in the stopped state for each axis.

If, in the stopped state, the positioning deviation exceeds the positioning deviation limit set for stopped state, a servo alarm is generated, and operation is stopped immediately (as in emergency stop).

1832

Feed stop positioning deviation for each axis

[Data type] 2-word axis

[Unit of data] Detection unit

[Valid data range] 0 to 99999999

Set the feed stop positioning deviation for each axis.

If the positioning deviation exceeds the feed stop positioning deviation during movement, pulse distribution and acceleration/deceleration control are stopped temporarily. When the positioning deviation drops to the feed stop positioning deviation or below, pulse distribution and acceleration/deceleration control are resumed.

The feed stop function is used to reduce overshoot in acceleration/deceleration mainly by large servo motors.

Generally, set the middle value between the positioning deviation limit during movement and the positioning deviation at rapid traverse as the feed stop positioning deviation.

1836

Servo error amount where reference position return is possible

[Data type] Byte axis

[Unit of data] Detection unit

[Valid data range] 0 to 127

This parameter sets a servo error used to enable reference position return in manual reference position return.

In general, set this parameter to 0. (When 0 is set, 128 is assumed as the default.)

Note

When bit 0 of parameter No. 2000 is set to 1, a value ten times greater than the value set in this parameter is used to make the check.

[Example] When the value 10 is set in this parameter, and bit 0 of parameter No.2000 is set to 1, reference

1850

Grid shift and reference position shift for each axis

[Data type] 2-word axis

[Unit of data] Detection unit

[Valid data range] 0 to ± 99999999

A grid shift is set for each axis.

To shift the reference position, the grid can be shifted by the amount set in this parameter. Up to the maximum value counted by the reference counter can be specified as the grid shift.

In case of parameter SFD (No. 1002#2) is 0: Grid shift

In case of parameter SFD (No. 1002#2) is 1: Reference point shift

Note

When this parameter has been set, the power must be turned off before operation is continued.

1851

Backlash compensating value for each axis

[Data type] Word axis

[Unit of data] Detection unit

[Valid data range] -9999 to +9999

Set the backlash compensating value for each axis.

When the machine moves in a direction opposite to the reference position return direction after the power is turned on, the first backlash compensation is performed.

1852

Backlash compensating value used for rapid traverse for each axis

[Data type] Word axis**[Unit of data]** Detection unit**[Valid data range]** -9999 to +9999

Set the backlash compensating value used in rapid traverse for each axis.

This parameter is valid when RBK, #4 of parameter 1800, is set to 1.

More precise machining can be performed by changing the backlash compensating value depending on the feedrate, the rapid traverse or the cutting feed.

Let the measured backlash at cutting feed be A and the measured backlash at rapid traverse be B. The backlash compensating value is shown below depending on the change of feedrate (cutting feed or rapid traverse) and the change of the direction of movement.

Fig.4.9 Backlash Compensating Value

Change of feedrate Change of direction of movement	Cutting feed to cutting feed	Rapid traverse to rapid traverse	Rapid traverse to cutting feed	Cutting feed to rapid traverse
Same direction	0	0	$\pm\alpha$	$\pm(-\alpha)$
Opposite direction	$\pm A$	$\pm B$	$\pm B (B+\alpha)$	$\pm B (B+\alpha)$

Notes

1 $a = (A-B)/2$

2 The positive or negative direction for compensating values is the direction of movement.

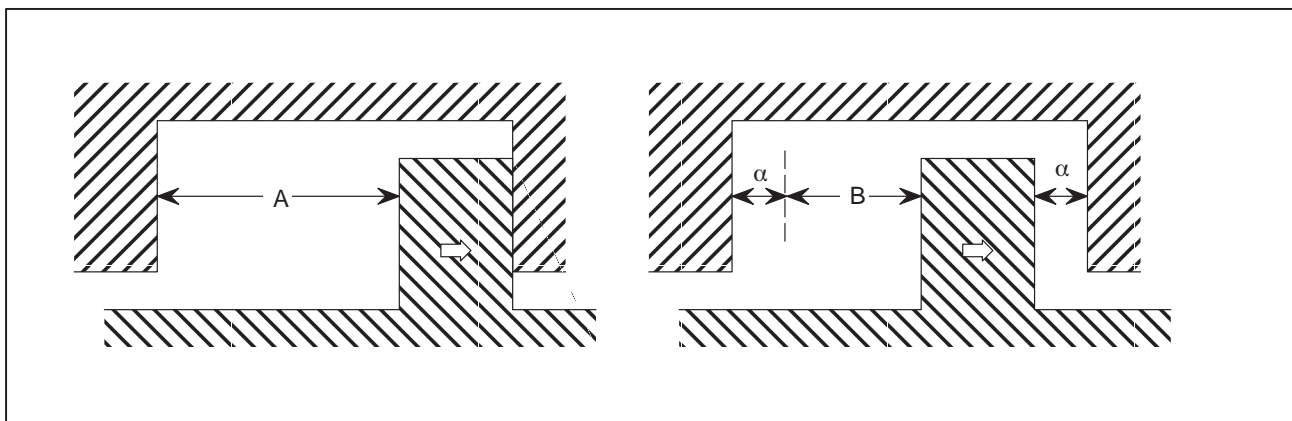

Fig.4.9 (b) Backlash Compensating Value

Notes

- 3 Assign the measured backlash at cutting feed (A) in parameter No. 1851 and that at rapid traverse (B) in parameter No. 1852.
- 4 Jog feed is regarded as cutting feed.
- 5 The backlash compensation depending on a rapid traverse and a cutting feed is not performed until the first reference position return is completed after the power is turned on. The normal backlash compensation is performed according to the value specified in parameter No. 1851 irrespective of a rapid traverse and a cutting feed.
- 6 The backlash compensation depending on a rapid traverse and a cutting feed is performed only when RBK, #4 of parameter No. 1800, is set to 1. When RBK is set to 0, the normal backlash is performed.

1870

Number of the program for storing servo trace data

[Data type] Word axis**[Valid data range]** 0 to 9999

Set the number of the program for storing servo trace data.

Notes

- 1 $a = (A-B)/2$
- 2 The positive or negative direction for compensating values is the direction of movement.

1871

Program number where servo trace data is stored (when the program number is 8 digits)

[Data type] 2-word axis**[Valid data range]** 0 to 99999999

Set a program number where servo trace data is to be stored, when the program number is 8 digits.

Caution) Do not use parameter No. 1870, which is dedicated to the standard function (4-digit 0 number).

1874

Number of the conversion coefficient for inductosyn position detection

1875

Denominator of the conversion coefficient for inductosyn position detection

Note

When this parameter has been set, the power must be turned off before operation is continued.

[Data type] Word axis

[Valid data range] 1 to 32767

Set a conversion coefficient for inductosyn position detection for each axis. The value set is determined as follows:

$$\text{No. 1874} \frac{\text{Number of position feedback pulses per motor revolution}}{\text{No. 1875}} = \frac{\quad}{1,000,000}$$

1876

One-pitch interval of the inductosyn

Note

When this parameter has been set, the power must be turned off before operation is continued.

[Data type] Word axis

[Unit of data] Detection unit

[Valid data range] 1 to 32767

Set a one-pitch interval of the inductosyn for each axis.

1877

Amount of inductosyn shift

Note

When this parameter has been set, the power must be turned off before operation is continued.

[Data type] Word axis

[Unit of data] Detection unit

[Valid data range] -32767 to 32767

Set the amount of inductosyn shift for each axis.

By using this parameter, calculate the machine position from the expression below.

$$\text{Machine position} = \left(\frac{\text{M-S} - (\text{parameter No. 1877})}{\lambda} \right) \text{Rounded off} \times \lambda + \text{S}$$

M: Absolute motor position (detection unit)

S : Data of offset from the inductosyn (detection unit)

λ : One-pitch interval of the inductosyn (detection unit) (Parameter No. 1876)

The remainder of (M-S) divided by λ approaches 0. (Normally, set the value of diagnostic data No.380.)

1880

Abnormal load detection alarm timer

[Data type] Word axis

[Unit of data] ms

[Valid data range] 0 to 32767 (200 msec is assumed when 0 is set)

This parameter sets the time from the detection of an abnormal load until a servo alarm is issued. The specified value is rounded up to the nearest integral multiple of 8 msec.

[Example] When 30 is specified, the value is rounded up to 32 (msec).

1890

Servo motor speed for detection

Note

When this parameter has been set, the power must be turned off before operation is continued.

[Data type] Word axis

[Unit of data] rpm

[Valid data range] 0 to 8000

The servo motor speed of each axis is monitored and a motor speed detection signal is output indicating whether the speed of each axis exceeds the value set in this parameter (set in the Y address specified in parameter No. 1891)

Note

No motor speed detection signals are output when the servo/spindle motor speed detection function is not used or 0 is set in this parameter.

1891

Initial value of the Y address where motor speed detection signals are output

Note

When this parameter has been set, the power must be turned off before operation is continued.

[Data type] Word axis

[Valid data range] 0 to 126, 1000 to 1013, 1020 to 1033

This parameter specifies the Y address where motor speed detection signals are output.

The spindle motor speeds and servo motor speed of each axis are monitored and motor speed detection signals are output to the Y address specified in this parameter and (Y address +1) to indicate whether speeds exceed the values set in the parameters.

- Y address n :Servo motor speed detection signals are output.
(See the description of parameter No. 1890.)
- Y address n+1 :Spindle motor speed detection signals are output.
(See the description of parameter No. 4345.)

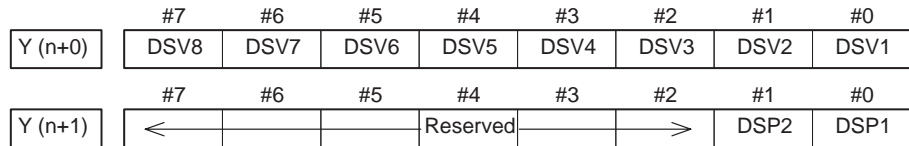

DSV1–DSV8 : Motor speed detection signals of servo motors for axis 1 to axis 8

DSP1, DSP2 : Motor speed detection signals of the first and second serial spindles

Notes

- 1 No motor speed detection signals are output when the servo/spindle motor speed detection function is not used, the value 0 or a value beyond the allowable data range is specified in this parameter, or an input/output address specified within the allowable data range represents an address where no I/O device is mounted.
- 2 Be sure to specify a Y address that is not used with a PMC sequence program (ladder).
- 3 When controlling two path lathe, ensure that the same value is not set for 1 path lathe and 2 path lathe . (Set a separate address for 1 path lathe and 2 path lathe.)

The following parameters are not explained in this manual:

Table 4.9 Parameters of Digital Servo (1/4)

No.	Data type	Contents							
2000	Bit axis				PGEXPD			DGPRM	PLC01
2001	Bit axis	AMR7	AMR6	AMR5	AMR4	AMR3	AMR2	AMR1	AMR0
2002	Bit axis				0	1			
2003	Bit axis	V0FST	OVSCMP	BLENBL	IPSPRS	PIENBL	OBENBL	TGALRM	
2004	Bit axis	DLY1	DLY0			TRW1	TRW0	TIB0	TIA0
2005	Bit axis		BRKCTL				DMR1/5	FEEDFD	
2006	Bit axis	TRCOMP	DCBEMF		MODEL ACCFB		PKVER	DBSTP	FCBLCM
2007	Bit axis	TQCTR	FAD						
2008	Bit axis								
2009	Bit axis	BLSTP	BLCUT				ADBLSH		SERDMY
2010	Bit axis	POLENB	HBCNTL	HBBLST	HBBPEST	BLTEN	LINEAR		
2011	Bit axis			RCCLP			MKH125	FFALWY	SYNMOD
2012	Bit axis			VCMD2	VCMD1			MSFEN	
2013	Bit axis	(Reserve)							
2014	Bit axis	(Reserve)							
2015	Bit axis		BLATY3	TDOUT	IND			SSG1	PGTWN
2016	Bit axis	NFIL8	NFIL7		SPS				ABNTDT
2017	Bit axis	PK2V25		RISCF			1VCHNG	IPCHNG	DBSTP
2018	Bit axis	PFBCPY				OVRQ11	OVRQ8	MOV OBS	
2019	Bit axis	DPFBCT							
2020	Word axis	Motor type							

Table 4.9 Parameters of Digital Servo (2/4)

No.	Data type	Contents
2021	Word axis	Load inertia ratio (LDINT)
2022	Word axis	Direction of motor rotation (DIRCTL)
2023	Word axis	Number of velocity detection feedback pulses (PULCO)
2024	Word axis	Number of position detection feedback pulses (PPLS)
2025	Word axis	
2026	Word axis	
2027	Word axis	
2028	Word axis	Position gain change effective speed (TWNSP)
2029	Word axis	Acceleration effective speed for integral function at low speed (INTSP1)
2030	Word axis	Deceleration effective speed for integral function at low speed (INTSP2)
2031	Word axis	Simplified synchronization alarm detection level (TCDIFF)
2032	Word axis	Integral gain change-over parameter (PUNCH)
2033	Word axis	Vibration-damping control position feedback pulse (PFBPLS)
2034	Word axis	Vibration-damping control gain (GAINBT)
2035	Word axis	Number of directly set feed-forward shifts (FMFSFL)
2036	Word axis	Slave axis damping compensation (SBDMPL)
2037	Word axis	(Reserve)
2038	Word axis	Spindle feed back coefficient
2039	Word axis	Second-stage acceleration of the Two-stage backlash acceleration function (BL3QUT)
2040	Word axis	Current loop gain (PK1)
2041	Word axis	Current loop gain (PK2)
2042	Word axis	Current loop gain (PK3)
2043	Word axis	Velocity loop gain (PK1V)
2044	Word axis	Velocity loop gain (PK2V)
2045	Word axis	Incomplete integral coefficient (PK3V)
2046	Word axis	Velocity loop gain (PK4V)
2047	Word axis	Velocity control observer parameter (POA1)
2048	Word axis	Improvement of velocity control backlash compensation (BLCMP)
2049	Word axis	Not used
2050	Word axis	Velocity control observer parameter (POK1)
2051	Word axis	Velocity control observer parameter (POK2)
2052	Word axis	Not used
2053	Word axis	Compensation for current non-operating area (PPMAX)
2054	Word axis	Compensation for current non-operating area (PDDP)
2055	Word axis	Compensation for current non-operating area (PHYST)
2056	Word axis	Back electromotive force compensation (EMFCMP)
2057	Word axis	Current phase control (PVPA)
2058	Word axis	Current phase control (PALPH)
2059	Word axis	Back electromotive force compensation (EMFBAS)
2060	Word axis	Torque limit (TQLIM)
2061	Word axis	Back electromotive force compensation (EMFLMT)
2062	Word axis	Overload protection coefficient (OVC1)

Table 4.9 Parameters of Digital Servo (3/4)

No.	Data type	Contents
2063	Word axis	Overload protection coefficient (OVC2)
2064	Word axis	TG alarm level (TGALMLV)
2065	Word axis	Overload protection coefficient (OVCLMT)
2066	Word axis	250- μ s acceleration feedback (PK2VAUX)
2067	Word axis	Torque command filter (TCFIL)
2068	Word axis	Feed-forward coefficient (FALPH)
2069	Word axis	Feed-forward filter coefficient (VFFLT)
2070	Word axis	Backlash compensation acceleration parameter (ERBLN)
2071	Word axis	Backlash compensation acceleration parameter (PBLCT)
2072	Word axis	Static-friction compensation acceleration (SFCCML)
2073	Word axis	Static-friction compensation stop decision time (PSPTL)
2074	Word axis	Velocity-dependent current loop gain (AALPH)
2075	Word axis	
2076	Word axis	Acceleration feedback gain (WKAC)
2077	Word axis	Overshoot preventive counter (OSCTP)
2078	Word axis	Numerator of dual position feedback conversion coefficient (PDPCH)
2079	Word axis	Denominator of dual position feedback conversion coefficient (PDPCL)
2080	Word axis	Time constant of dual position feedback (DPFEX)
2081	Word axis	Zero width of dual position feedback
2082	Word axis	Backlash acceleration end amount (BLEND)
2083	Word axis	Brake control hold time (MOFCT)
2084	Word axis	Numerator of DMR when the flexibly feed gear is used
2085	Word axis	Denominator of DMR when the flexibly feed gear is used
2086	Word axis	Rated current parameter (RTCURR)
2087	Word axis	Torque offset (TCPRLD)
2088	Word axis	Mechanical speed feedback coefficient (MCNFB)
2089	Word axis	Base pulse in backlash acceleration (BLBSL)
2090	Word axis	
2091	Word axis	Non-linear control input (ACCSPL)
2092	Word axis	Look-ahead feed forward coefficient (ADFF1)
2093	Word axis	Incomplete integral (speed command mode) (VMPK3V)
2094	Word axis	Second backlash acceleration (BLCMP2)
2095	Word axis	Mechanical distortion compensation (AHDRT)
2096	Word axis	Radius parameter for radial error serial output (RADUS)
2097	Word axis	Static-friction compensation stop (SMCNT)
2098	Word axis	Phase progress compensation coefficient in deceleration (PIPVPL)
2099	Word axis	1 pulse suppress level (ONEPSL)
2100	Word axis	
2101	Word axis	
2102	Word axis	Final clamp value of the actual current limit (DBLMI)
2103	Word axis	Restored amount in abnormal load detection (ABVOF)
2104	Word axis	Threshold in the alarm of abnormal load detection (ABTSH)

Table 4.9 Parameters of Digital Servo (4/4)

No.	Data type	Contents
2105	Word axis	Torque constant (TRQCST)
2106	Word axis	
2107	Word axis	Speed loop gain override (VLGOVR)
2108	Word axis	
2109	Word axis	Fine Acc/Dec time constant (BELLTC)
2110	Word axis	Current phase control 2 (MGSTCM)
2111	Word axis	Deceleration torque limit (DETQLM)
2112	Word axis	Linear motor AMR conversion factor (AMRDML)
2113	Word axis	Notch filter cutoff frequency (NFILT)
2114	Word axis	Second-stage acceleration multiplier of the Two-stage backlash acceleration function (BL3OVR)
2115	Word axis	Arbitrary data serial output address (SRTADL)
2116	Word axis	Abnormal load detection friction compensation (FRCCMP)
2117	Word axis	
2118	Word axis	Maximum value for dual position feedback error difference detection (DERMXL)
2119	Word axis	
2120	Word axis	
2121	Word axis	Super-precision pulse conversion factor (SBPDNL)
2122	Word axis	Super-precision detection resistance conversion factor (SBAMPL)
2123	Word axis	
2124	Word axis	
2125	Word axis	
2126	Word axis	

4.10 PARAMETERS OF DI/DO

	#7	#6	#5	#4	#3	#2	#1	#0
3001	MHI					RWM		

[Data type] Bit

RWM RWD signal indicating that rewinding is in progress
 0 : Output only when the tape reader is being rewound by the reset and rewind signal RRW
 1 : Output when the tape reader is being rewound or a program in memory is being rewound by the reset and rewind signal RRW

MHI Exchange of strobe and completion signals for the M, S, T, and B codes
 0 : Normal
 1 : High-speed

	#7	#6	#5	#4	#3	#2	#1	#0
3002				IOV				

[Data type]

IOV For the feedrate override signal, second feedrate override signal, and rapid traverse override signal:
 0 : Negative logic is used.
 1 : Positive logic is used.

	#7	#6	#5	#4	#3	#2	#1	#0
3003	MVG	MVX	DEC		DIT	ITX		ITL
		MVX	DEC		DIT	ITX		ITL

[Data type] Bit

ITL Interlock signal
 0 : Enabled
 1 : Disabled

ITX Interlock signals for each axis
 0 : Enabled
 1 : Disabled

DIT Interlock for each axis direction
 0 : Enabled
 1 : Disabled

DEC Deceleration signal (*DEC1 to *DEC8) for reference position return
 0 : Deceleration is applied when the signal is 0.
 1 : Deceleration is applied when the signal is 1.

MVX The axis-in-movement signal is set to 0 when:
 0 : Distribution for the axis is completed. (The signal is set to 0 in deceleration.)
 1 : Deceleration of the axis is terminated, and the current position is in the in-position.

If, however, a parameter specifies not to make in-position during deceleration, the signal turns to "0" at the end of deceleration.

MVG While drawing using the dynamic graphics function (with no machine movement), the axis-in-movement signal is:

- 0 : Output
- 1 : Not output

Note
In case of M series the signal is not output.

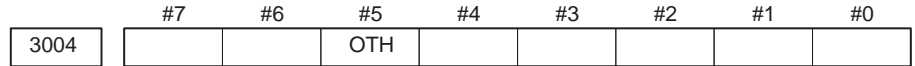

[Data type] Bit

OTH The overtravel limit signal is:

- 0 : Checked
- 1 : Not checked

Note
For safety, usually set 0 to check the overtravel limit signal.



GDC As the deceleration signal for reference position return:

- 0 : X009/X007 is used.
- 1 : G196/G1196 is used. (X009/X007 is disabled.)

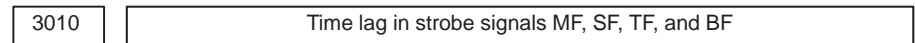

[Data type] Word

[Unit of data] 1 ms

[Valid data range] 16 to 32767

The time required to send strobe signals MF, SF, TF, and BF after the M, S, T, and B codes are sent, respectively.

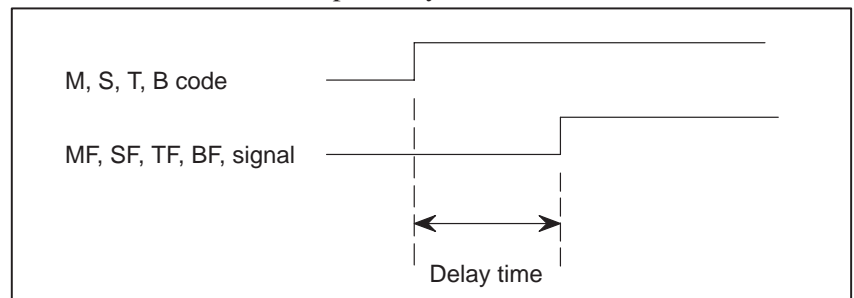

Fig.4.10 (a) Delay Time of the strobe signal

Note

The time is counted in units of 8 ms. If the set value is not a multiple of eight, it is raised to the next multiple of eight.

[Example] When 30 is set, 32 ms is assumed.
 When 32 is set, 32 ms is assumed.
 When 100 is set, 104 ms is assumed.

3011

Acceptable width of M, S, T, and B function completion signal (FIN)

[Data type] Word

[Unit of data] 1 ms

[Valid data range] 16 to 32767

Set the minimum signal width of the valid M, S, T, and B function completion signal (FIN).

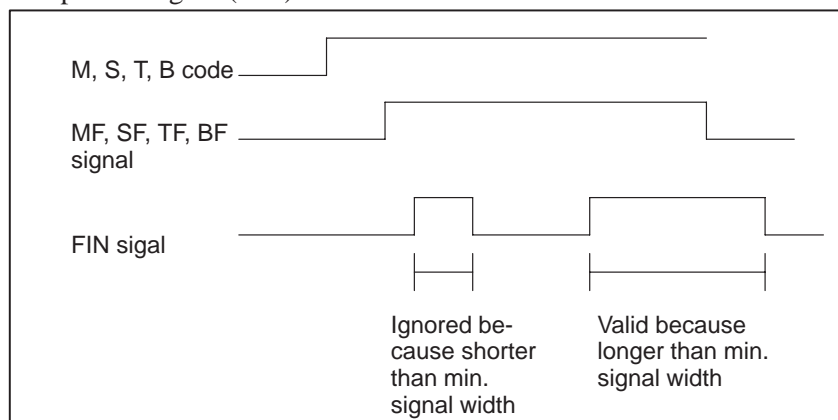

Fig.4.10 (b) Valid Width of the FIN (M,S, T, and B Function Completion) Signal

Note

The time is counted in units of 8 ms. If the set value is not a multiple of eight, it is raised to the next multiple of eight.

[Example] When 30 is set, 32 ms is assumed.

3017

Output time of reset signal RST

[Data type] Byte

[Unit of data] 16 ms

[Valid data range] 0 to 255

To extend the output time of reset signal RST, the time to be added is specified in this parameter.

RST signal output time = time required for reset + parameter × 16 ms

3030	Allowable number of digits for the M code
3031	Allowable number of digits for the S code
3032	Allowable number of digits for the T code
3033	Allowable number of digits for the B code

[Data type] Byte

[Valid data range] 1 to 8

Set the allowable numbers of digits for the M, S, T, and B codes.

Note

Up to 5 digits can be specified in the S code

4.11 PARAMETERS OF CRT/MDI, DISPLAY, AND EDIT

	#7	#6	#5	#4	#3	#2	#1	#0
3100	COR			FPT	FKY			
	COR				FKY			

[Data type] Bit

FKY CRT/MDI keyboard
0 : Small type keys are used.
1 : Standard keys are used.

FPT CRT/MDI keyboard for CAP-II
0 : Not used.
1 : Used

Note

When CAP-II function is equipped, this parameter is not required to be set to 1.

COR 9-inch CRT
0 : Monochrome display
1 : Color display

	#7	#6	#5	#4	#3	#2	#1	#0
3101	SBA			BGD			KBF	

[Data type] Bit

KBF When the screen or mode is changed, the contents of the key-in buffer are:
0 : Cleared.
1 : Not cleared.

Note

When KBF = 1, the contents of the key-in buffer can all be cleared at one time by pressing the SHIFT key followed by the CAN key.

BGD In background editing, a program currently selected in the foreground:
0 : Cannot be selected. (BP/S alarm No. 140 is issued disabling selection.)
1 : Can be selected. (However, the program cannot be edited, only displayed.)

SBA When two systems are controlled, the current positions on the current position display screen are displayed:
0 : In the order of tool post 1, followed by tool post 2.
1 : In the order of tool post 2, followed by tool post 1.

	#7	#6	#5	#4	#3	#2	#1	#0
3102		SPN	HNG	ITA	CHI	FRN	GRM	JPN

[Data type] Bit type

Note

When this parameter is set, turn off the power once.

The language used in the display on the CRT is selected.

SPN	HNG	ITA	CHI	FRN	GRM	JPN	CRT display language
0	0	0	0	0	0	0	English
0	0	0	0	0	0	1	Japanese
0	0	0	0	0	1	0	German
0	0	0	0	1	0	0	French
0	0	0	1	0	0	0	Chinese (Taiwanese)
0	0	1	0	0	0	0	Italian
0	1	0	0	0	0	0	Hangul
1	0	0	0	0	0	0	Spanish

	#7	#6	#5	#4	#3	#2	#1	#0
3103	ABR							

[Data type] Bit

- ABR** When two systems are controlled using a 9" CRT display unit and absolute position/relative position display requires two current position display screens (when five or more controlled axes are involved in total):
- 0 : The first screen displays tool post 1 data and the second screen displays tool post 2 data.
 - 1 : The first screen displays the data of the tool post selected with the tool post selection signal and the second screen displays the data of the other tool post.

Note

When ABR = 1, bit7 (SBA) of parameter No. 3101 is disabled.

	#7	#6	#5	#4	#3	#2	#1	#0
3104	DAC	DAL	DRC	DRL	PPD			MCN

[Data type] Bit

MCN Machine position

0 : Not displayed according to the unit of input.

(Regardless of whether input is made in mm or inches, the machine position is displayed in mm for millimeter machines, or in inches for inch machines.)

1 : Displayed according to the unit of input.
 (When input is made in mm, the machine position is displayed in mm, and when input is made in inches, the machine position is displayed in inches accordingly.)

PPD Relative position display when a coordinate system is set
 0 : Not preset
 1 : Preset

Notes

When PPD is set to 1 and the absolute position display is preset by one of the following, the relative position display is also preset to the same value as the absolute position display:

- 1) The manual reference position return
- 2) Setting of a coordinate system by G92 (G50 for T series G code system A)

DRL Relative position
 0 : The actual position displayed takes into account tool length offset (M series) or tool offset (T series).
 1 : The programmed position displayed does not take into account tool length offset (M series) or tool offset (T series).

Note

When tool geometry compensation of the T system is to be performed by shifting the coordinate system (with bit 4 (LGT) of parameter No. 5002 set to 0), the programmed position, ignoring tool offset, is displayed (with this parameter set to 1), but the programmed position, ignoring tool geometry compensation, cannot be displayed.

DRC Relative position
 0 : The actual position displayed takes into account cutter compensation (M series) or tool nose radius compensation (T series).
 1 : The programmed position displayed does not take into account cutter compensation (M series) or tool nose radius compensation (T series).

DAL Absolute position
 0 : The actual position displayed takes into account tool length offset (M series) or tool offset (T series).
 1 : The programmed position displayed does not take into account tool length offset (M series) or tool offset (T series).

Note

When tool geometry compensation of the T system is to be performed by shifting the coordinate system (with bit 4 (LGT) of parameter No. 5002 set to 0), the programmed position, ignoring tool offset, is displayed (with this parameter set to 1), but the programmed position, ignoring tool geometry compensation, cannot be displayed.

- DAC** Absolute position
 0 : The actual position displayed takes into account cutter compensation (M series) or tool nose radius compensation (T series).
 1 : The programmed position displayed does not take into account cutter compensation (M series) or tool nose radius compensation (T series).

	#7	#6	#5	#4	#3	#2	#1	#0
3105						DPS	PCF	DPF
	SMF					DPS	PCF	DPF

[Data type] Bit

- DPF** Display of the actual speed on the current position display screen, program check screen and program screen (MD1 mode)
 0 : Not displayed
 1 : Displayed
- PCF** Addition of the movement of the PMC-controlled axes to the actual speed display
 0 : Added
 1 : Not added
- DPS** Actual spindle speed and T code
 0 : Not always displayed
 1 : Always displayed
- SMF** During simplified synchronous control, movement along a slave axis is:
 0 : Included in the actual speed display
 1 : Not included in the actual speed display

Note
 This parameter is valid when simplified synchronous control is applied according to the setting of parameter No. 8311 (master and slave axes can be arbitrarily selected).

	#7	#6	#5	#4	#3	#2	#1	#0
3106	OHS		SOV	OPH	SPD		GPL	
	OHS	DAK	SOV	OPH			GPL	

[Data type] Bit

- GPL** On the program list screen, the list-by-group function is:
 0 : Disabled
 1 : Enabled
- SPD** Names for actual spindle speed values are displayed:
 0 : Regardless of the selected spindle position coder
 1 : Depending of the selected spindle position coder

SPD=0		SPD=1	
Spindles 1 and 2		Spindles 1	Spindles 2
S		S1	S2
SACT		SACT1	SACT2
ACT, S			

Note

When SPD is set to 1, during Two-path control, the actual spindle speed names for a spindle of path 2 are displayed in reverse video.

OPH The operation history screen is:
0 : Not displayed.
1 : Displayed.

SOV The spindle override value is:
0 : Not displayed.
1 : Displayed.

Note

This parameter is enabled only when bit 2 (DPS) of parameter No. 3105 is set to 1.

DAK When absolute coordinates are displayed in the three-dimensional coordinate conversion mode:
0 : Coordinates in the program coordinate system are displayed.
1 : Coordinates in the workpiece coordinate system are displayed.

OHS Operation history sampling is:
0 : Performed.
1 : Not performed.

	#7	#6	#5	#4	#3	#2	#1	#0
3107	MDL		DMN	SOR		DNC		NAM

[Data type] Bit

- NAM** Program list
0 : Only program numbers are displayed.
1 : Program numbers and program names are displayed.
- DNC** Upon reset, the program display for DNC operation is:
0 : Not cleared
1 : Cleared
- SOR** Display of the program directory
0 : Programs are listed in the order of registration.
1 : Programs are listed in the order of program number.
- DMN** G code menu
0 : Displayed
1 : Not displayed
- MDL** Display of the modal state on the program display screen
0 : Not displayed
1 : Displayed (only in the MDI mode)

	#7	#6	#5	#4	#3	#2	#1	#0
3108								
							PCT	

[Data type] Bit

- PCT** On the 9" CRT program check screen and 14" CRT position screen, T code displayed
 0 : is a T code specified in a program (T).
 1 : is a T code specified by the PMC (HD. T/NX. T)

	#7	#6	#5	#4	#3	#2	#1	#0
3109						IKY	DWT	
		BGO					DWT	

[Data type] Bit

- DWT** Characters G and W in the display of tool wear/geometry compensation amount
 0 : The characters are displayed at the left of each number.
 1 : The characters are not displayed.
- IKY** On the offset screen, the **[INPUT]** soft key is:
 0 : Displayed
 1 : Not displayed
- BGO** On the background drawing screen, when the <OFFSET> function key is pressed:
 0 : The machining-side screen is resumed.
 1 : A background drawing offset, workpiece coordinate system offset, and macro variable are displayed. (In this case, "BGGRP" appears in the bottom right section of the screen, enabling you to check the data for background drawing.)

	#7	#6	#5	#4	#3	#2	#1	#0
3111	NPA	OPS	OPM			SVP	SPS	SVS

[Data type] Bit

- SVS** Servo tuning screen
 0 : Not displayed
 1 : Displayed
- SPS** Spindle tuning screen
 0 : Not displayed
 1 : Displayed
- SVP** Synchronization errors displayed on the spindle tuning screen
 0 : Instantaneous values are displayed.
 1 : Peak-hold values are displayed.
- OPM** Operating monitor
 0 : Not displayed
 1 : Displayed
- OPS** The speedometer on the operating monitor screen indicates:

0 : Spindle motor speed

1 : Spindle speed

NPA Action taken when an alarm is generated or when an operator message is entered

0 : The display shifts to the alarm or message screen.

1 : The display does not shift to the alarm or message screen.

	#7	#6	#5	#4	#3	#2	#1	#0
3112			OPH		EAH	OMH		SGD

Note

When this parameter is set, the power must be turned off before operation is continued.

[Data type] Bit

SGD Servo waveform

0 : Not displayed

1 : Displayed

Note

If SGD is set to 1, no graphic display other than servo waveform display is done.

OMH The external operator message history screen is:

0 : Not displayed.

1 : Displayed.

EAH The improved alarm history is:

0 : Not used.

1 : Used.

OPH The operation history log function is:

0 : Displayed.

1 : Enable.

	#7	#6	#5	#4	#3	#2	#1	#0
3113	MS1	MS0						MHC

[Data type] Bit

MHC External operator message history data:

0 : Cannot be cleared.

1 : Can be cleared.

(Such data can be cleared using the **[CLEAR]** soft key.)

MS0, MS1 A combination of the number of characters preserved as external operator message history data and the number of history data items is set according to the table below.

MS1	MS0	Number of history data characters	Number of history data items
0	0	255	8
0	1	200	10
1	0	100	18
1	1	50	32

Note

When the values of MS0 and MS1 are changed, all preserved external operator message history data is cleared.

	#7	#6	#5	#4	#3	#2	#1	#0
3114		ICS	IUS	IMS	ISY	IOF	IPR	IPO

[Data type] Bit

- IPO** When the <POS> function key is pressed while the position display screen is being displayed:
0 : The screen is changed.
1 : The screen is not changed.
- IPR** When the <PROG> function key is pressed while the program screen is being displayed:
0 : The screen is changed.
1 : The screen is not changed.
- IOF** When the <OFFSET/SETTING> function key is pressed while the offset/setting screen is being displayed:
0 : The screen is changed.
1 : The screen is not changed.
- ISY** When the <SYSTEM> function key is pressed while the system screen is being displayed:
0 : The screen is changed.
1 : The screen is not changed.
- IMS** When the <MESSAGE> function key is pressed while the message screen is being displayed:
0 : The screen is changed.
1 : The screen is not changed.
- IUS** When the <USER> or <GRAPH> function key is pressed while the user or graph screen is being displayed:
0 : The screen is changed.
1 : The screen is not changed.
- ICS** When the <CUSTOM> function key is pressed while the custom screen is being displayed:
0 : The screen is changed.
1 : The screen is not changed.

	#7	#6	#5	#4	#3	#2	#1	#0
3115						SFMx	NDAx	NDPx
							NDAx	NDPx

[Data type] Bit axis

- NDPx** Display of the current position for each axis
 0 : The current position is displayed.
 1 : The current position is not displayed.
- NDAx** Position display using absolute coordinates and relative coordinates is:
 0 : Performed.
 1 : Not performed. (Machine coordinates are displayed.)
- SFMx** In current position display, subscripts are:
 0 : Added to the absolute, relative, and machine coordinate axis names.
 1 : Assed only to the machine coordinate axis names.

Note
 This parameter is disabled when two systems are controlled.

3120	Time from the output of an alarm to the termination of sampling (waveform diagnosis function)
------	-----------------------------------------------------------------------------------------------

[Data type] Word

[Unit of data] ms

[Valid data range] 1 to 32760

When the waveform diagnosis function is used, this parameter sets the time form the output of a servo alarm until data collection. Storage operation is stopped because of the alarm. (This means that the termination of data collection can be delayed by a specified time.)

3122	Time interval used to record time data in operation history
------	-------------------------------------------------------------

[Data type] Word

[Unit of data] Minutes

[Valid data range] 0 to 1439

Time data is recorded in operation history at set intervals. When 0 is specified in this parameter, 10 minutes is assumed as the default. However, note that time data is not recorded if there is no data to be recorded at the specified time.

3123	Time until screen clear function is applied
------	---------------------------------------------

[Data type] Bytes

[Unit of data] Minutes

[Valid data range] 1 to 255

This parameter specifies the period that must elapse before the screen clear function is applied. If 0 is set, the screen is not cleared.

Moreover, this parameter is valid only when it is set on the path 1 side.

3130	Axis display order for current position display screens
------	---------------------------------------------------------

[Data type] Byte axis

[Valid data range] 0, 1 to the number of controlled axes

This parameter specifies the order in which axes are displayed on the current position display screens (absolute, relative, overall, and handle interrupt screens) during Two-path control when the 9" display is used.

Note

This parameter is valid only for the common screens for Two-path control. Axes are displayed in the order of their axis numbers on individual screens for each path and Two-axis simultaneous display screens.

3131	Subscript of each axis name
------	-----------------------------

[Data type] Byte axis

This parameter specifies a subscript (one character) of each axis name with a code (Two-path control).

The one character subscript specified by this parameter is displayed after the axis name on the current position screen to discriminate the coordinates of axes belonging to one path from those of another path.

Notes

- 1 This parameter is dedicated to the Two-path control.
- 2 Specify this parameter for each path.
- 3 For characters and codes, see the correspondence table in Appendix 1.
- 4 When code 0 is specified, 1 or 2 is displayed.

[Example] When the configuration of axes is X, Z, C and Y in path 1 and X, Z, and B in path 2

- (1) Setting for path 1

Parameter 3131x 65 (A)	XA, Z1, CS, and Y1 are displayed as axis names.
Parameter 3131z 49 (1)	
Parameter 3131c 83 (S)	
Parameter 3131y 0 (1)	

- (2) Setting for path 2

Parameter 3131x 66 (B)	XB, Z2, and B are displayed as axis names.
Parameter 3131z 0 (2)	
Parameter 3131b 32 (space)	

3132	Axis name (absolute coordinate) for current position display
3133	Axis name (relative coordinate) for current position display

[Data type] Byte axis

[Valid data range] 0 to 255

These parameters set the axis name for current position display.

When G code system B or C is used, the axis name set in parameter No. 3132 is used for both absolute and relative coordinate axes.

The values set in these parameters are used only for display. For a command address, the axis name set in parameter No. 1020 is used.

When 0 is specified in these parameters, the value set in parameter No. 1020 is used.

3134	Axis display order on workpiece coordinate system screen and workpiece shift screen
------	-------------------------------------------------------------------------------------

[Data type] Byte axis

[Valid data range] 0, 1 to the number of controlled axes

This parameter specifies the order in which axes are displayed on the workpiece coordinate system screen and workpiece shift screen (for T series).

3141	Path name (1st character)
3142	Path name (2nd character)
3143	Path name (3rd character)
3144	Path name (4th character)
3145	Path name (5th character)
3146	Path name (6th character)
3147	Path name (7th character)

[Data type] Byte

Specify a path name with codes (Two-path control).

Any character strings consisting of alphanumeric characters and symbols (up to seven characters) can be displayed as path names on the CRT screen, instead of HEAD1 and HEAD2 for T series, and instead of PATH1 and PATH2 for M series.

Notes

- 1 This parameter is dedicated to the Two-path control.
- 2 Specify these parameters for each series.
- 3 For characters and codes, see the correspondence table in 2.1.15 software operator's panel.
- 4 When codes are 0, HEAD1 and HEAD2 for T series and PATH1 or PATH2 for M series are displayed.

[Example] When the names of path 1 and 2 are specified as TURRET1 and TURRET2, respectively.

- | | |
|---------------------------------------------------------------------------------------------------------------------------------------------------------------------------------------------------------------------|---------------------------------------------------------------------------------------------------------------------------------------------------------------------------------------------------------------------|
| (1) Setting for path 1
Parameter 3141 = 84 (T)
Parameter 3142 = 85 (U)
Parameter 3143 = 82 (R)
Parameter 3144 = 82 (R)
Parameter 3145 = 69 (E)
Parameter 3146 = 84 (T)
Parameter 3147 = 49 (1) | (2) Setting for path 2
Parameter 3141 = 84 (T)
Parameter 3142 = 85 (U)
Parameter 3143 = 82 (R)
Parameter 3144 = 82 (R)
Parameter 3145 = 69 (E)
Parameter 3146 = 84 (T)
Parameter 3147 = 50 (2) |
|---------------------------------------------------------------------------------------------------------------------------------------------------------------------------------------------------------------------|---------------------------------------------------------------------------------------------------------------------------------------------------------------------------------------------------------------------|

3151	Number of the axis for which the first load meter for the servo motor is used
3152	Number of the axis for which the second load meter for the servo motor is used
3153	Number of the axis for which the third load meter for the servo motor is used
3154	Number of the axis for which the fourth load meter for servo motor is used
3155	Number of the axis for which the fifth load meter for servo motor is used
3156	Number of the axis for which the sixth load meter for servo motor is used
3157	Number of the axis for which the seventh load meter for servo motor is used
3158	Number of the axis for which the eighth load meter for servo motor is used

[Data type] Byte

[Valid data range] 0, 1, . . . , the number of control axes

Set the numbers of the axes for which measurement values on the load meters for the three servo motors are displayed. When only two load meters are used, set the third axis number to 0.

	#7	#6	#5	#4	#3	#2	#1	#0
3201		NPE	N99			REP	RAL	RDL

[Data type] Bit

RDL When a program is registered by input/output device external control
 0 : The new program is registered following the programs already registered.

1 : All registered programs are deleted, then the new program is registered.

Note that programs which are protected from being edited are not deleted.

RAL When programs are registered through the reader/puncher interface
 0 : All programs are registered.

1 : Only one program is registered.

REP Action in response to an attempt to register a program whose number is the same as that of an existing program

0 : An alarm is generated.

1 : The existing program is deleted, then the new program is registered.

Note that if the existing program is protected from being edited, it is not deleted, and an alarm is generated.

N99 With an M99 block, when bit 6 (NPE) of parameter No. 3201 = 0, program registration is assumed to be:
 0 : Completed
 1 : Not completed

NPE With an M02, M30, or M99 block, program registration is assumed to be:
 0 : Completed
 1 : Not completed

	#7	#6	#5	#4	#3	#2	#1	#0
3202		PSR		NE9		CND	OLV	NE8

[Data type] Bit

NE8 Editing of subprograms with program numbers 8000 to 8999
 0 : Not inhibited
 1 : Inhibited

The following edit operations are disabled:

- (1) Program deletion (Even when deletion of all programs is specified, programs with program numbers 8000 to 8999 are not deleted.)
- (2) Program output (Even when outputting all programs is specified, programs with program numbers 8000 to 8999 are not output.)
- (3) Program number search
- (4) Program editing of registered programs
- (5) Program registration
- (6) Program collation
- (7) Displaying programs

OLV When a program other than the selected program is deleted or output:
 0 : The display of the selected program is not held.
 1 : The display of the selected program is held.

CND By using the [**CONDENSE**] soft key on the program directory screen, the program condensing operation is:
 0 : Not performed. (The [**CONDENSE**] soft key is not displayed.)
 1 : Performed.

NE9 Editing of subprograms with program numbers 9000 to 9999
 0 : Not inhibited
 1 : Inhibited

- (1) Program deletion (Even when deletion of all programs is specified, programs with program numbers 9000 to 9999 are not deleted.)
- (2) Program punching (Even when punching of all programs is specified, programs with program numbers 9000 to 9999 are not punched.)
- (3) Program number search
- (4) Program editing after registration
- (5) Program registration
- (6) Program collation

(7) Displaying programs

PSR Search for the program number of a protected program

0 : Disabled

1 : Enabled

	#7	#6	#5	#4	#3	#2	#1	#0
3203	MCL	MER	MZE	PIO				
	MCL	MER	MZE					

[Data type] Bit

PIO When two systems are controlled, program input/output is:

0 : Controlled separately for each tool post.

1 : Controlled on a Two-system basis for tool post 1 and tool post 2.

MIE After MDI operation is started, program editing during operation is:

0 : Enabled

1 : Disabled

MER When the last block of a program has been executed at single block operation in the MDI mode, the executed block is:

0 : Not deleted

1 : Deleted

Note

When MER is set to 0, the program is deleted if the end-of-record mark (%) is read and executed. (The mark % is automatically inserted at the end of a program.)

MCL Whether a program prepared in the MDI mode is cleared by reset

0 : Not deleted

1 : deleted

	#7	#6	#5	#4	#3	#2	#1	#0
3204			SPR	P9E	P8E	EXK		PAR

[Data type] Bit

PAR When a small keyboard is used, characters [and] are:

0 : Used as [and].

1 : Used as (and).

EXK The input character extension function is:

0 : Not used.

1 : Used. (When a small keyboard is used, the three characters (,), and @ can be entered using soft keys.)

P8E Editing of subprograms 80000000 to 89999999 is:

0 : Not inhibited

1 : Inhibited

The following editing types become impossible.

(1) Program deletion (Programs numbered in the 80000000 range will not be deleted even if all-program deletion is specified.)

- (2) Program output (Programs numbered in the 80000000 range will not be output even if all-program output specified.)
- (3) Program search by number
- (4) Program editing after registration
- (5) Program registration
- (6) Program collation
- (7) Program display

P9E Editing of subprograms 90000000 to 99999999 are:

- 0 : Not inhibited
- 1 : Inhibited

The following editing types become impossible.

- (1) Program deletion (Programs numbered in the 90000000 range will not be deleted even if all-program deletion is specified.)
- (2) Program output (Programs numbered in the 90000000 range will not be output even if all-program output specified.)
- (3) Program search by number
- (4) Program editing after registration
- (5) Program registration
- (6) Program collation
- (7) Program display

SPR Program numbers in the 9000 range for specific programs are:

- 0 : Not added with 90000000
- 1 : Added with 90000000

[Example]

The program numbers for G codes used to call custom macros are as follows:

SPR = 0: 00009010 to 00009019

SPR = 1: 90009010 to 90009019

Subprogram numbers 9500 to 9510 used by the pattern data input function are as follows:

SPR = 0: 00009500 to 00009510

SPR = 1: 90009500 to 90009510

3210	Password
------	----------

[Data type] 2-word axis

This parameter sets a password for protecting program Nos. 9000 to 9999. When a value other than zero is set in this parameter and this value differs from the keyword set in parameter No. 3211, bit 4 (NE9) of parameter No. 3202 for protecting program Nos. 9000 to 9999 is automatically set to 1. This disables the editing of program Nos. 9000 to 9999. Until the value set as the password is set as a keyword, NE9 cannot be set to 0 and the password cannot be modified.

Notes

- 1 The state where password = 0 and password = keyword is referred to as the locked state. When an attempt is made to modify the password by MDI input operation in this state, the warning message "WRITE PROTECTED" is displayed to indicate that the password cannot be modified. When an attempt is made to modify the password with G10 (programmable parameter input), P/S alarm No. 231 is issued.
- 2 When the value of the password is not 0, the parameter screen does not display the password. Care must be taken in setting a password.

3211

Keyword

[Data type] 2-word axis

When the value set as the password (set in parameter No. 3210) is set in this parameter, the locked state is released and the user can now modify the password and the value set in bit 4 (NE9) of parameter No. 3202.

Note

The value set in this parameter is not displayed. When the power is turned off, this parameter is set to 0.

3216

Increment in sequence numbers inserted automatically

Setting entry is acceptable.

[Data type] Word**[Valid data range]** 0 to 9999

Set the increment for sequence numbers for automatic sequence number insertion (when SEQ, #5 of parameter 0000, is set to 1.)

	#7	#6	#5	#4	#3	#2	#1	#0
3290	KEY	MCM		IWZ	WZO	MCV	GOF	WOF

[Data type] Bit**WOF** Setting the tool offset value by MDI key input is:

0 : Not disabled

1 : Disabled (With parameter No. 3294 and No. 3295, set the offset number range in which updating the setting is to be disabled.)

GOF Setting the tool offset value by MDI key input is:

0 : Not disabled

1 : Disabled (With parameter No. 3294 and No. 3295, set the offset number range in which updating the setting is to be disabled.)

MCV Macro variable setting by MDI key input is:

0 : Not disabled

1 : Disabled

WZO Setting a workpiece zero point offset value by MDI key input is:

0 : Not disabled

1 : Disabled

IWZ Setting a workpiece zero point offset value or workpiece shift value (T-series) by MDI key input in the automatic operation activation or halt state is:

0 : Not disabled

1 : Disabled

MCM The setting of custom macros by MDI key operation is:

0 : Enabled regardless of the mode.

1 : Enabled only in the MDI mode.

KEY For memory protection keys:

0 : The KEY1, KEY2, KEY3, and KEY4 signals are used.

1 : Only the KEY1 signal is used.

Note

The functions of the signals depend on whether KEY = 0 or KEY = 1.

When KEY = 0:

- KEY1: Enables a tool offset value and a workpiece zero point offset value to be input.
- KEY2: Enables setting data and macro variables to be input.
- KEY3: Enables program registration and editing.
- KEY4: (Reserved)

When KEY = 1:

- KEY1: Enables program registration and editing, and enables PMC parameter input.
- KEY2 to KEY4: Not used

3294	Start number of tool offset values whose input by MDI is disabled
3295	Number of tool offset values (from the start number) whose input by MDI is disabled

[Data type] Word

When the modification of tool offset values by MDI key input is to be disabled using bit 0 (WOF) of parameter No. 3290 and bit 1 (GOF) of parameter No. 3290, parameter Nos. 3294 and 3295 are used to set the range where such modification is disabled. In parameter No. 3294, set the offset number of the start of tool offset values whose modification is disabled. In parameter No. 3295, set the number of such values.

When 0 or a negative value is set in parameter No. 3294 or parameter No. 3295, no modification of the tool offset values is allowed.

When the value set with parameter No. 3294 is greater than the maximum tool offset count, no modification is allowed.

[Example]

The following setting disables the modification of both the tool geometry compensation values and tool wear compensation values corresponding to offset numbers 100 to 110:

Bit 1 (GOF) of parameter No. 3290 = 1 (Disables tool offset value modification.)

Bit 0 (WOF) of parameter No. 3290 = 1 (Disables tool wear compensation value modification.)

Parameter No. 3294 = 100

Parameter No. 3295 = 11

If bit 0 (WOF) of parameter No. 3290 is set to 0, the modification of the tool offset values alone is disabled. The tool wear compensation values may be modified.

4.12 PARAMETERS OF PROGRAMS

	#7	#6	#5	#4	#3	#2	#1	#0
3401	GSC	GSB					FCD	DPI
			ABS	MAB				DPI

[Data type] Bit

- DPI** When a decimal point is omitted in an address that can include a decimal point
 0 : The least input increment is assumed.
 1 : The unit of mm, inches, or second is assumed. (Pocket calculator type decimal point input)
- FCD** When an F command and a G command (G98, G99) for feed per minute or feed per rotation are specified in the same block, and the G command (G98, G99) is specified after the F command, the F command is:
 0 : Assumed to be specified in the mode (G98 or G99) when the F command is specified
 1 : Assumed to be specified in the mode of the G command (G98 or G99) of the same block

Notes

1 When FCD = 1:

If the block containing a G command (G98, G99) does not include an F command, the last F command specified is assumed to be specified in the G command mode of the block.

Example

N1 G99 ;

N2 Faaaa G98 ; - Faaaa is assumed to be specified in the G98 mode.

N3 Fbbbb ; - Fbbbb is assumed to be specified in the G98 mode.

N4 G99 ; - Fbbbb is assumed to be specified in the G99 mode.

2 In G code system B or C, G98 and G99 function are specified in G94 and G95.

- MAB** Switching between the absolute and incremental commands in MDI operation
 0 : Performed by G90 or G91
 1 : Depending on the setting of ABS, #5 of parameter No. 3401
- ABS** Program command in MDI operation
 0 : Assumed as an incremental command
 1 : Assumed as an absolute command

Note

ABS is valid when MAB, #4 of parameter No. 3401, is set to 1.

GSB, GSC The G code system is set.

GSC	GSB	G code
0	0	G code system A
0	1	G code system B
1	0	G code system C

	#7	#6	#5	#4	#3	#2	#1	#0
3402	G23	CLR			G91			G01
		CLR			G91	G19	G18	G01

[Data type] Bit

G01 Mode entered when the power is turned on or when the control is cleared
 0 : G00 mode (positioning)
 1 : G01 mode (linear interpolation)

G18 and G19 Plane selected when power is turned on or when the control is cleared

G19	G18	G17, G18 or G19 mode
0	0	G17 mode (plane XY)
0	1	G18 mode (plane ZX)
1	0	G19 mode (plane YZ)

G91 When the power is turned on or when the control is cleared
 0 : G90 mode (absolute command)
 1 : G91 mode (incremental command)

CLR Reset button on the CRT/MDI panel, external reset signal, reset and rewind signal, and emergency stop signal

0 : Cause reset state.
 1 : Cause clear state.

For the reset and clear states, refer to Operator's manual (B-62574EN or B-62764EN).

G23 When the power is turned on
 0 : G22 mode
 1 : G23 mode

	#7	#6	#5	#4	#3	#2	#1	#0
3403		AD2	CIR					

[Data type] Bit

CIR When neither the distance (I, J, K) from a start point to the center nor an arc radius (R) is specified in circular interpolation (G02, G03):

- 0 : The tool moves to an end point by linear interpolation.
- 1 : P/S alarm No. 022 is issued.

- AD2** Specification of the same address two or more times in a block is:
- 0 : Enabled
 - 1 : Disabled (P/S alarm No. 5074)

Notes

- 1 When 1 is set, specifying two or more G codes of the same group in a block will also result in an alarm being issued.
- 2 Up to three M codes can be specified in a single block.

	#7	#6	#5	#4	#3	#2	#1	#0
3404	M3B	EOR	M02	M#)		SBP	POL	
	M3B	EOR	M02	M30		SBP	POL	NOP

[Data type] Bit

- NOP** When a program is executed, a block consisting of an O number, EOB, or N number is:
- 0 : Not ignored, but regarded as being one block.
 - 1 : Ignored.
- POL** For a command address allowing a decimal point, omission of the decimal point is:
- 0 : Enabled
 - 1 : Disabled (P/S alarm No. 5073)
- SBP** Address P of the block including M198 in the subprogram call function
- 0 : Indicating a file number
 - 1 : Indicating a program number
- M30** When M30 is specified in a memory operation:
- 0 : M30 is sent to the machine, and the head of the program is automatically searched for. So, when the ready signal FIN is returned and a reset or reset and rewind operation is not performed, the program is executed, starting from the beginning.
 - 1 : M30 is sent to the machine, but the head of the program is not searched for. (The head of the program is searched for by the reset and rewind signal.)
- M02** When M02 is specified in memory operation
- 0 : M02 is sent to the machine, and the head of the program is automatically searched for. So, when the end signal FIN is returned and a reset or reset and rewind operation is not performed, the program is executed, starting from the beginning.
 - 1 : M02 is sent to the machine, but the head of the program is not searched for. (The head of the program is searched for by the reset and rewind signal.)
- EOR** When the end-of-record mark (%) is read during program execution:
- 0 : P/S alarm No. 5010 occurs. (Automatic operation is stopped, and the system enters the alarm state.)
 - 1 : No alarm occurs. (Automatic operation is stopped, and the system is reset.)

- M3B** The number of M codes that can be specified in one block
 0 : One
 1 : Up to three

	#7	#6	#5	#4	#3	#2	#1	#0
3405	QAB	QLG	DDP	CCR	G36	PPS	DWL	AUX
							DWL	AUX

[Data type] Bit

- AUX** The least increment of the command of the second miscellaneous function specified with a decimal point
 0 : Assumed to be 0.001
 1 : Depending on the input increment. (For input in mm, 0.001 is assumed, or for input in inches, 0.0001 is assumed.)
- DWL** The dwell time (G04) is:
 0 : Always dwell per second.
 1 : Dwell per second in the feed per minute mode, or dwell per rotation in the feed per rotation mode.
- PPS** The passing-point signal output function (Series 16-TA, Series 18-TA) is:
 0 : Not used
 1 : Used
- G36** For a G code used with the automatic tool compensation function:
 0 : G36/G37 is used.
 1 : G37.1/G37.2 is used.
 If it is necessary to perform circular threading (counterclockwise), set this parameter to 1.
- CCR** Addresses used for chamfering and corner rounding
 0 : Address used for chamfering and corner rounding is I or K, not C. In direct drawing dimension programming, addresses 'C, 'R, and 'A (with comma) are used in stead of C, R, and A.
 1 : Addresses used for chamfering, corner rounding, and direct drawing dimension programming are C, R, and A without comma. Thus, addresses A and C cannot be used as the names of axes.
- DDP** Angle commands by direct drawing dimension programming
 0 : Normal specification
 1 : A supplementary angle is given.
- QLG** When the passing-point signal output function is used, the remaining distance to be traveled specified in address “,Q” is:
 0 : The combined distance of all axes
 1 : The distance of the longest axis

Note

This parameter is valid when bit 7 (QAB) of parameter No. 3405 = 0.

- QAB** When the passing-point signal output function is used, address “,Q” specifies:
 0 : Remaining distance to be traveled
 1 : Coordinate value of the longest axis

	#7	#6	#5	#4	#3	#2	#1	#0
3406	C07		C05	C04	C03	C02	C01	
	C07		C05	C04	C03	C02	C01	
	#7	#6	#5	#4	#3	#2	#1	#0
3407					C11	C10		C08
	C15	C14	C13		C11	C10	C09	C08
	#7	#6	#5	#4	#3	#2	#1	#0
3408								C16
				C20	C19	C18	C17	C16
	#7	#6	#5	#4	#3	#2	#1	#0
3409	CFH							
	CFH							C24

[Data type] Bit

Cxx (xx: 01 to 24) When bit 6 (CLR) of parameter No. 3402 is 1, the reset button on the CRT/MDI panel, the external reset signal, the reset and rewind signal, or emergency stop will,

0 : Clear the G code with group number xx.

1 : Not clear the G code with group number xx.

CFH When bit 6 (CLR) of parameter No. 3402 is 1, the reset button on the CRT/MDI panel, the external reset signal, the reset and rewind signal, or emergency stop will,

0 : Clear F codes, H codes (for the M series), D codes (for the M series), and T codes (for the T series).

1 : Not clear F codes, H codes (for the M series), D codes (for the M series), and T codes (for the T series).

3410	Tolerance of arc radius
------	-------------------------

[Data type] 2-word

[Unit of data]

Increment system	IS-A	IS-B	IS-C	Unit
Metric input	0.01	0.001	0.0001	mm
Inch input	0.001	0.0001	0.00001	inch

[Valid data range] 1 to 99999999

When a circular interpolation command (G02, G03) is executed, the tolerance for the radius between the start point and the end point is set. If the difference of radii between the start point and the end point exceeds the tolerance set here, a P/S alarm No. 20 is informed.

Note

When the set value is 0, the difference of radii is not checked.

3411	M code preventing buffering 1
3412	M code preventing buffering 2
3413	M code preventing buffering 3
⋮	⋮
3420	M code preventing buffering 10

[Data type] Byte

[Valid data range] 0 to 255

Set M codes that prevent buffering the following blocks. If processing directed by an M code must be performed by the machine without buffering the following block, specify the M code.

M00, M01, M02, and M30 always prevent buffering even when they are not specified in these parameters.

3421	Minimum value 1 of M code preventing buffering
3422	Maximum value 1 of M code preventing buffering
3423	Minimum value 2 of M code preventing buffering
3424	Maximum value 2 of M code preventing buffering
3425	Minimum value 3 of M code preventing buffering
3426	Maximum value 3 of M code preventing buffering
3427	Minimum value 4 of M code preventing buffering
3428	Maximum value 4 of M code preventing buffering
3429	Minimum value 5 of M code preventing buffering
3430	Maximum value 5 of M code preventing buffering
3431	Minimum value 6 of M code preventing buffering
3432	Maximum value 6 of M code preventing buffering

[Data type] Word

[Valid data range] 0 to 65535

When a specified M code is within the range specified with parameter Nos. 3421 and 3422, 3423 and 3424, 3425 and 3426, 3427 and 3428, 3429 and 3430, or 3431 and 3432, buffering for the next block is not performed until the execution of the block is completed.

Note

- 1 The specification of a minimum value that exceeds the specified maximum value is invalid.
- 2 When there is only one data item, set the following:
minimum value = maximum value.

3441	First of the M codes assigned to item numbers 100 to 199
3442	First of the M codes assigned to item numbers 200 to 299
3443	First of the M codes assigned to item numbers 300 to 399
3444	First of the M codes assigned to item numbers 400 to 499

[Data type] 2-word

[Valid data range] 0 to 99999999

The M code group check function checks if a combination of up to three M codes specified in a block is valid, and the function issues an alarm if an invalid combination is detected. Before this function can be used, up to 500 M codes must be divided into no more than 128 groups. A set number from 0 to 499 is assigned to each of the 500 M codes. The group to which each M code with a set number assigned belongs is specified using the M code group setting screen.

The set numbers 0 to 499 correspond to M000 to M499. These parameters allow arbitrary M codes to be assigned in units of 100 M codes to the set numbers 100 to 499.

Parameter No. 3441: Sets the M codes corresponding to the set numbers 100 to 199.

Parameter No. 3442: Sets the M codes corresponding to the set numbers 200 to 299.

Parameter No. 3443: Sets the M codes corresponding to the set numbers 300 to 399.

Parameter No. 3444: Sets the M codes corresponding to the set numbers 400 to 499.

Each parameter sets the M code that corresponds to the first of the set numbers allocated to the parameter, thus assigning 100 successive M codes. For example, when parameter No. 3441 = 10000 is set, the M codes corresponding to the set numbers 100 to 199 are M10000 to M10099.

Notes

1 When the value 0 is set in a parameter, the specification of 100 added to the value of the previous parameter is assumed. For example, when No. 3441 = 10000, and No. 3442 = 0 are specified:

The M codes corresponding to the set numbers 100 to 199 are: M10000 to M10099

The M codes corresponding to the set numbers 200 to 299 are: M10100 to M10199

Specifying 0 for parameter No. 3441 has the same effect as specifying for parameter No. 3441 = 100.

2 When a is specified for parameter No. 3441, b is specified for parameter No. 3442, c is specified for parameter No. 3443, and d is specified for parameter No. 3444, the following relationships must be satisfied:

$a + 99 < b$, $b + 99 < c$, $c + 99 < d$

3450	#7	#6	#5	#4	#3	#2	#1	#0
								AUP

[Data type] Bit

AUP When a command for the second miscellaneous function contains a decimal point or negative sign:

0 : The command is invalid.

1 : The command is valid.

Note

For the T series, a decimal point and negative sign are supported for commands for the second miscellaneous function, regardless of the setting made with this parameter.

3460	
	Address for second miscellaneous function

[Data type] Byte

This parameter specifies the address used for the second miscellaneous function, as follows:

Address	A	B	C	U	V	W
Set value	65	66	67	85	86	87

Notes

1 Address B is assumed when a value other than the above is set.

2 Axes names cannot be used to specify the address.

4.13 PARAMETERS OF PITCH ERROR COMPENSATION

3620	Number of the pitch error compensation position for the reference position for each axis
------	------------------------------------------------------------------------------------------

Note
When this parameter is set, the power must be turned off before operation is continued.

[Data type] Word axis
[Unit of data] Number
[Valid data range] 0 to 1023

Set the number of the pitch error compensation position for the reference position for each axis.

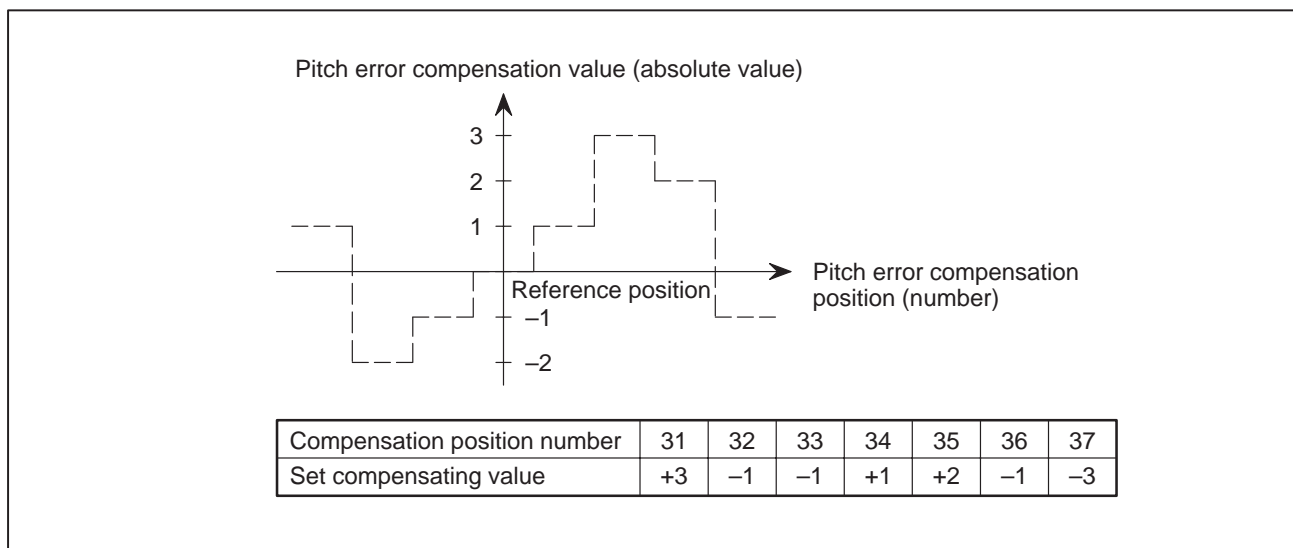

Fig.4.13 Pitch Error Compensation Position Number and Value (Example)

In the above example, set 33 as the number of the pitch error compensation position for the reference position.

3621	Number of the pitch error compensation position at extremely negative position for each axis
------	----------------------------------------------------------------------------------------------

Note
When this parameter is set, the power must be turned off before operation is continued.

[Data type] Word axis

[Unit of data] Number

[Valid data range] 0 to 1023

Set the number of the pitch error compensation position at the extremely negative position for each axis.

3622

Number of the pitch error compensation position at extremely positive position for each axis

Note

When this parameter is set, the power must be turned off before operation is continued.

[Data type] Word axis

[Unit of data] Number

[Valid data range] 0 to 1023

Set the number of the pitch error compensation position at the extremely positive position for each axis.

Note

This value must be larger than set value of parameter (No. 3620).

3623

Magnification for pitch error compensation for each axis

Note

When this parameter is set, the power must be turned off before operation is continued.

[Data type] Byte axis

[Unit of data] 1

[Valid data range] 0 to 100

Set the magnification for pitch error compensation for each axis.

If the magnification is set to 1, the same unit as the detection unit is used for the compensation data.

3624

Interval between pitch error compensation positions for each axis

Note

When this parameter is set, the power must be turned off before operation is continued.

[Data type] 2-word axis

[Unit of data]

Increment system	IS-A	IS-B	IS-C	Unit
Millimeter machine	0.01	0.001	0.0001	mm
Inch machine	0.001	0.0001	0.00001	inch
Rotation axis	0.01	0.001	0.0001	deg

[Valid data range] 0 to 99999999

The pitch error compensation positions are arranged with equally spaced. Set the space between two adjacent positions for each axis.

The minimum interval between pitch error compensation positions is limited and obtained from the following equation:

Minimum interval of pitch error compensation positions = maximum feedrate (rapid traverse rate)/3750

Unit mm, inches, deg

[Example]

When the maximum rapid traverse rate is 15000 mm/min, the minimum interval between pitch error compensation positions is 4 mm.

Examples of parameters

Example 1) For linear axis

- Machine stroke: -400 mm to + 800 mm
- Interval between the pitch error compensation positions: 50 mm
- No. of the compensation position of the reference position: 40

If the above is specified, the No. of the farthest compensation point in the negative direction is as follows:

$$\begin{aligned} & \text{No. of the compensation position of the reference position} - (\text{Machine stroke length in the negative direction} / \text{Interval between the compensation points}) + 1 \\ & = 40 - 400/50 + 1 \\ & = 33 \end{aligned}$$

No. of the farthest compensation position in the positive direction is as follows:

$$\begin{aligned} & \text{No. of the compensation position of the reference position} + (\text{Machine stroke length in the positive direction} / \text{Interval between the compensation positions}) \\ & = 40 + 800/50 \\ & = 56 \end{aligned}$$

The correspondence between the machine coordinate and the compensation position No. is as follows:

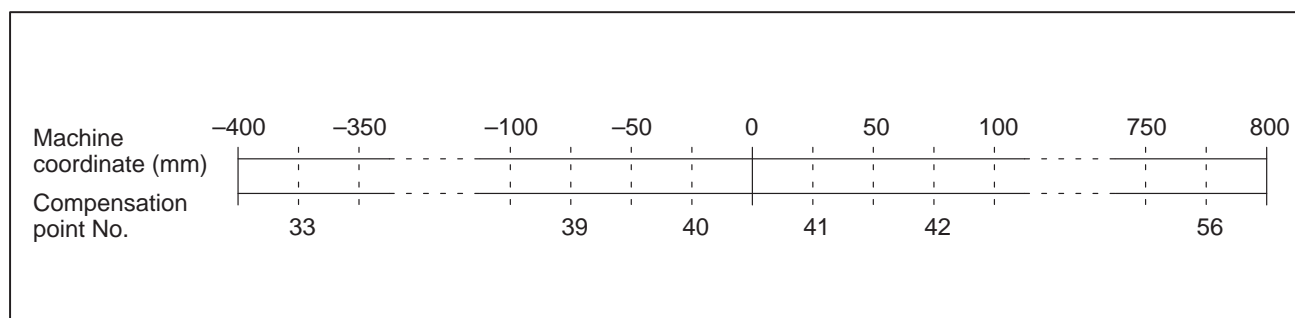

The compensation value is output at the compensation position No. corresponding to each section between the coordinates.

The following is an example of the compensation values.

No.	33	34	35	36	37	38	39	40	41	42	43	44	45	46	47	48	49
Compensation values	+2	+1	+1	-2	0	-1	0	-1	+2	+1	0	-1	-1	-2	0	+1	+2

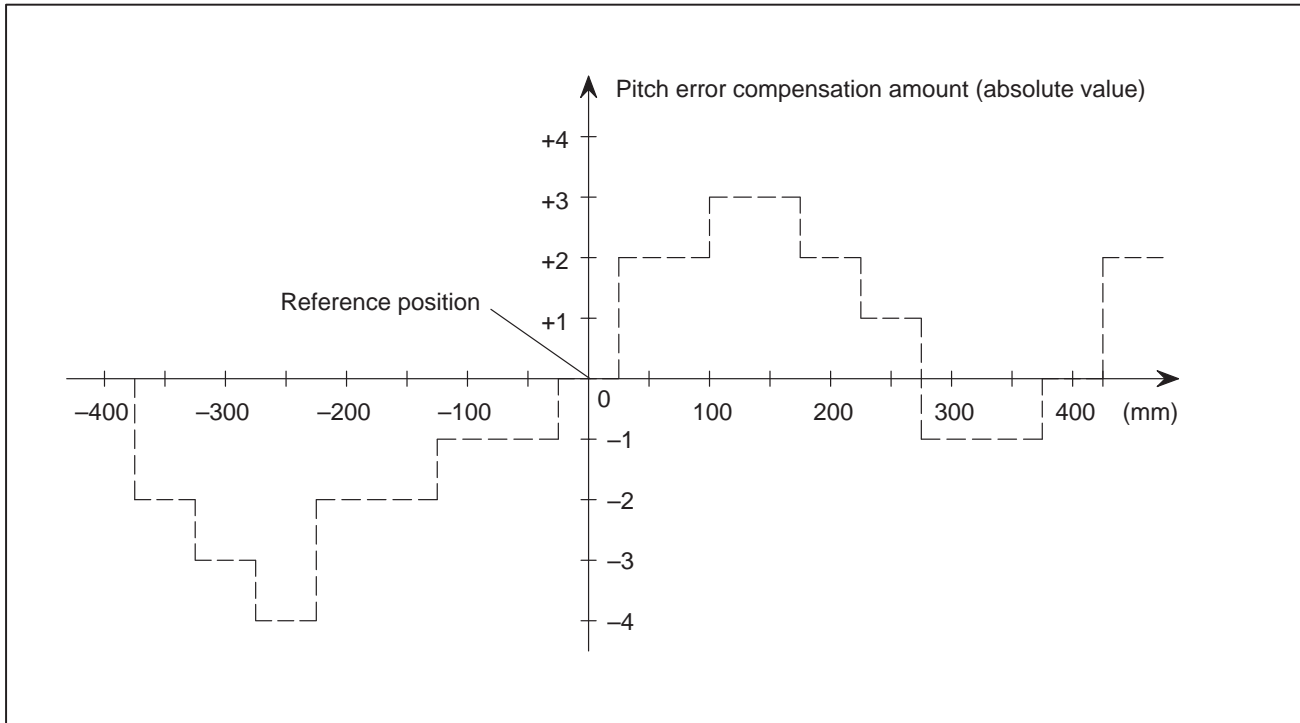

Example 2) For the rotation axis

- Amount of movement per rotation: 360°
- Interval between pitch error compensation position: 45°
- No. of the compensation position of the reference position: 60

If the above is specified, the No. of the farthest compensation position in the negative direction for the rotation axis is always equal to the compensation position No. of the reference position.

The No. of the farthest compensation position in the positive direction is as follows:

$$\begin{aligned}
 & \text{No. of the compensation position of the reference position} + (\text{Move amount per rotation} / \text{Interval between the compensation position}) \\
 &= 60 + 360/45 \\
 &= 68
 \end{aligned}$$

The correspondence between the machine coordinate and the compensation position No. is as follows:

The compensation value is output at the circled position.

If the sum of the compensation value from 61 to 68 is not zero, the pitch error per rotation accumulates, resulting in a positional shift.

For compensation position 60, set the same compensation value as for 68.

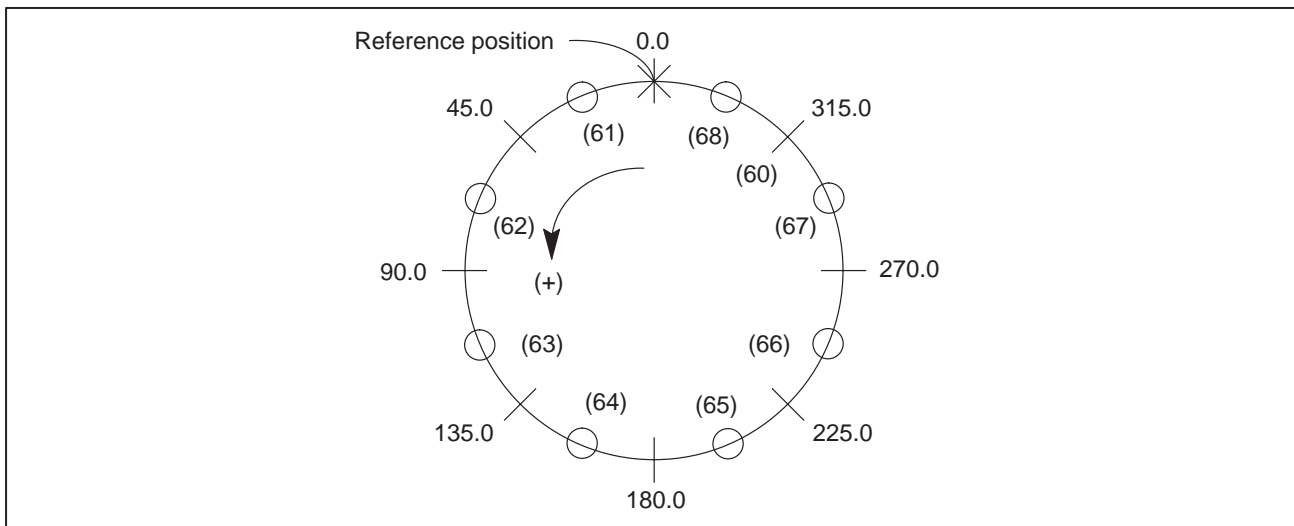

The following is an example of compensation values.

No. of the compensation position	60	61	62	63	64	65	66	67	68
Compensation value	+1	-2	+1	+3	-1	-1	-3	+2	+1

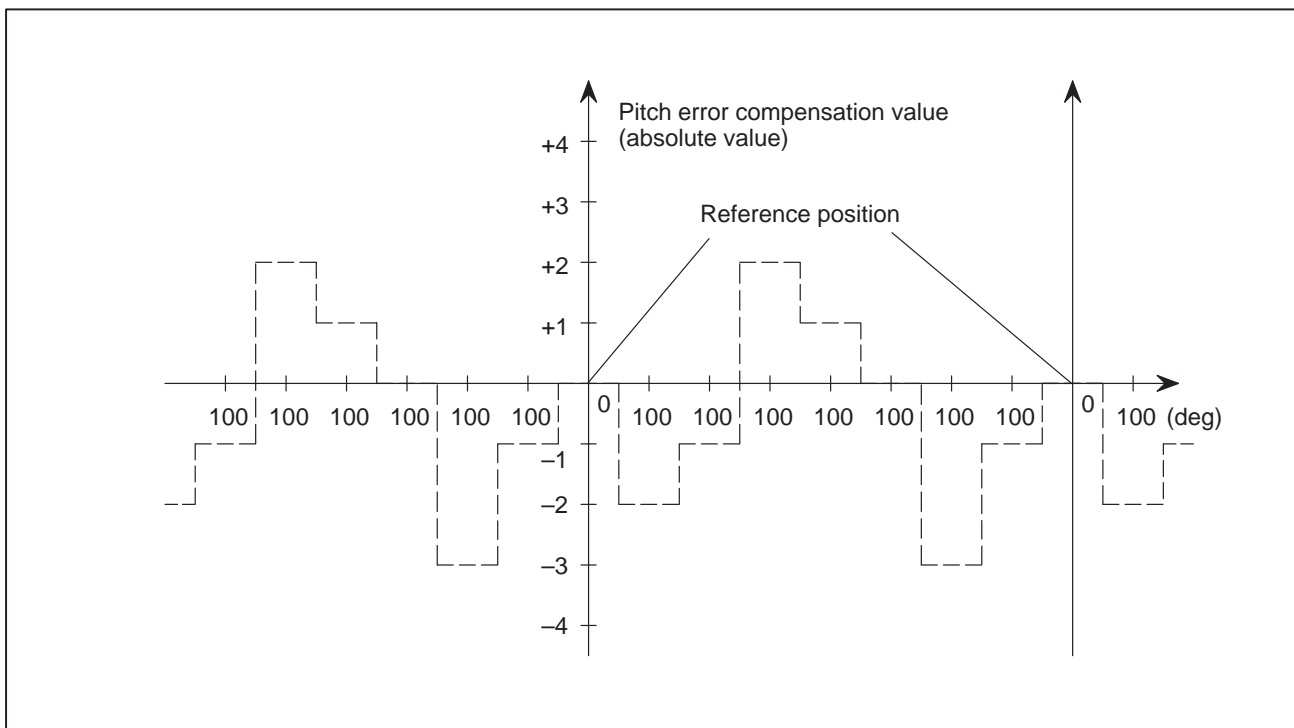

4.14 PARAMETERS OF SPINDLE CONTROL

	#7	#6	#5	#4	#3	#2	#1	#0
3700							NRF	

[Data type] Bit type

NRF The first move command (such as G00 and G01) after the serial spindle is switched to Cs axis contouring control performs:

0 : Positioning after returning to the reference position.

1 : Normal positioning.

	#7	#6	#5	#4	#3	#2	#1	#0
3701			SS3	SS2			ISI	

ISI The serial interface for the first and second spindles are:

0 : Used.

1 : Not used.

Note

This parameter is valid when the spindle serial output option is provided. It is used when the CNC is started with serial interface control for the first and second serial spindles disabled temporarily (for example, for CNC startup adjustment). Usually, it should be set to 0.

If the serial interface for the third serial spindle is disabled for the same reason, parameter SS3 (bit 5 of parameter No. 3701) must be 0. (This parameter does not disable the serial interface of the third spindle.)

SS2 In serial spindle control, the second spindle is:

0 : Not used.

1 : Used.

Notes

This parameter is valid, when the spindle serial output option is provided and parameter ISI (bit 1 of parameter No. 3701) is 0.

When the spindle synchronization option is provided, it is set automatically when power is switched on. Setting this parameter enables:

- 1 Confirmation of connection of the second serial spindle amplifier, and communication with it
- 2 Control of the second spindle during asynchronous control (SIND2)

The simplified spindle synchronization function requires that two serial spindles be connected. So this parameter must be set; it will not be set automatically. When this parameter is set, it is also necessary to set the serial spindle parameter for the second spindle.

SS3 In serial spindle control, the third spindle is:

0 : Not used.

1 : Used.

Note

This parameter is valid, when the Series 16/18 is performing single-path control and the spindle output option and the three-spindle serial output option are provided.

Parameter setting		Serial spindles to be used
SS3	SS2	
×	×	First serial spindle only
×	○	First and second serial spindles
○	○	First, second, and third spindles

	#7	#6	#5	#4	#3	#2	#1	#0
3702	ECS	ESS	EAS	ESI	OR2	OR1	EMS	OR3
					OR2	OR1	EMS	OR3

Note

When this parameter is set, the power must be turned off before operation is continued.

[Data type] Bit

OR3 The spindle orientation function based on an externally set stop position is:

0 : Not used by the third spindle motor.

1 : Used by the third spindle motor.

Note

When the spindle orientation function based on an externally set stop position is used, the position coder-based spindle orientation stop position set parameters (No. 4031 and No. 4204) are ineffective.

EMS Multi-spindle control function

0 : Used

1 : Not used

Note

If the multi-spindle control function is not required for one path in two-path control, specify this parameter for the path to which the multi-spindle control function need not be applied.

OR1: Whether the stop-position external-setting type orientation function is used by the first spindle motor

0 : Not used

1 : Used

OR2 Whether the stop-position external-setting type orientation function is used by the second spindle motor

0 : Not used

1 : Used

ESI The spindle positioning function is

0 : Used

1 : Not used

Note

This parameter is used when the spindle positioning option specified with two-path control, and the spindle positioning function is not required for either path. Set ESI to 1 for a system that does not require the spindle positioning function.

EAS For tool post 1 (or tool post 2), the S analog output function is:

0 : Used.

1 : Not used.

ESS For tool post 1 (or tool post 2), the S serial output function is:

0 : Used.

1 : Not used.

- ECS** For tool post 1 (or tool post 2), the Cs contour control function is:
 0 : Used.
 1 : Not used.

Note

Parameter EAS, ESS, and ECS are used for 16-TB 2-path control.
 These parameters are used to determine whether the optional function, S analog output function, S serial output function, and Cs contour control function, are used for each tool post.

	#7	#6	#5	#4	#3	#2	#1	#0
3703							RSI	2SP

Note

When this parameter is set, the power must be turned off before operation is continued.

[Data type] Bit type

- 2SP** Specifies whether one or two spindles are controlled (16-TB 2-path control).
 0 : One spindle (two tool posts)
 1 : Two spindle (two tool posts)
- RSI** Spindle command selection for 2-path control :
 0 : Affects commands from SIND for the first spindle
 1 : Does not affect commands from SIND for the first spindle
 (Spindle commands from SIND always control spindles in the same path, regardless of spindle command selection signals SLSPA and SLSPB <G063 bits 2 and 3>.)

	#7	#6	#5	#4	#3	#2	#1	#0
3705				EVS			RSI	ESF
		SFA	NSF		SGT	SGB	GST	ESF

[Data type] Bit

- ESF** When the spindle control function (S analog output or S serial output) is used, and the constant surface speed control function is used or bit 4 (GTT) of parameter No. 3705 is set to 1:
 0 : S codes and SF are output for all S commands.
 1 : S codes and SF are not output for an S command in constant surface speed control mode (G96 mode) or for an S command used to specify maximum spindle speed clamping (G50S—;).

Notes
 For the T series, this parameter is enabled when bit 4 (EVS) of parameter No. 3705 is set to 1.
 For the M series, SF is not output:
 (1) For an S command used to specify maximum spindle speed clamping (G92S—;) in constant surface speed control mode
 (2) When bit 5 (NSF) of parameter No. 3705 is set to 1

- GST:** The SOR signal is used for:
 0 : Spindle orientation
 1 : Gear shift
- SGB:** Gear switching method
 0 : Method A (Parameters 3741 to 3743 for the maximum spindle speed at each gear are used for gear selection.)
 1 : Method B (Parameters 3751 and 3752 for the spindle speed at the gear switching point are used for gear selection.)
- SGT:** Gear switching method during tapping cycle (G84 and G74)
 0 : Method A (Same as the normal gear switching method)
 1 : Method B (Gears are switched during tapping cycle according to the spindle speed set in parameters 3761 and 3762).
- EVS** When the spindle control function (S analog output or S serial output) is used, S codes and SF are:
 0 : Not output for an S command.
 1 : Output for an S command.

Note
 The output of S codes and SF for an S command in constant surface speed control mode (G96), or for an S command used to specify maximum spindle speed clamping (G50S—;) depends on the setting of bit 0 (ESF) of parameter No. 3705.

- NSF:** When an S code command is issued in constant surface speed control,
 0 : SF is output.
 1 : SF is not output.
- SFA:** The SF signal is output:
 0 : When gears are switched.
 1 : Irrespective of whether gears are switched.

	#7	#6	#5	#4	#3	#2	#1	#0
3706	TCW	CWM	ORM		PCS		PG2	PG1
	TCW	CWM	ORM	GTT			PG2	PG1

[Data type] Bit

PG2 and PG1 Gear ratio of spindle to position coder

Magnification	PG2	PG1
×1	0	0
×2	0	1
×4	1	0
×8	1	1

$$\text{Magnification} = \frac{\text{Number of spindle revolutions}}{\text{Number of position coder revolutions}}$$

PCS When multi-spindle control is applied to two tool posts in two-path control, this parameter specifies whether a position coder feedback signal from the other tool post is selectable, regardless of the state of the PC2SLC signal (bit 7 of G028/bit 7 of G1028) of the other tool post:
 0 : Not selectable.
 1 : Selectable. (To select a position coder for the other tool post, the SLPCA signal (bit 2 of G064) and the SLPCB signal (bit 3 of G064) are used.)

Note

Multi-spindle control based on the same serial spindle must be applied to both tool posts.

GTT Selection of a spindle gear selection method

0 : Type M.

1 : Type T.

Notes

1 Type M:

The gear selection signal is not entered. In response to an S command, the CNC selects a gear according to the speed range of each gear specified beforehand in parameters. Then the CNC reports the selection of a gear by outputting the gear selection signal. The spindle speed corresponding to the gear selected by the gear selection signal is output.

Type T:

The gear selection signal is entered. The spindle speed corresponding to the gear selected by this signal is output.

2 When the constant surface speed control option is selected, type T is selected, regardless of whether this parameter is specified.

3 When type T spindle gear switching is selected, the following parameters have no effect:

No. 3705#2 SGB, No. 3751, No. 3752, No. 3705#3 SGT, No. 3761, No. 3762, No. 3705#6 SFA, No. 3735, No. 3736

However, parameter No. 3744 is valid.

ORM Voltage polarity during spindle orientation

0 : Positive

1 : Negative

TCW, CWM Voltage polarity when the spindle speed voltage is output

TCW	CWM	Voltage polarity
0	0	Both M03 and M04 positive
0	1	Both M03 and M04 negative
1	0	M03 positive, M04 negative
1	1	M03 negative, M04 positive

	#7	#6	#5	#4	#3	#2	#1	#0
3707							P22	P21

[Data type] Bit type

P22 and P21 Gear ratio of spindle to second position coder

Magnification	P22	P21
×1	0	0
×2	0	1
×4	1	0
×8	1	1

$$\text{Magnification} = \frac{\text{Number of spindle revolutions}}{\text{Number of position coder revolutions}}$$

	#7	#6	#5	#4	#3	#2	#1	#0
3708				SVD			SAT	SAR
				SVD				SAR

[Data type] Bit

SAR: The spindle speed arrival signal is:
 0 : Not checked
 1 : Checked

SAT: Check of the spindle speed arrival signal at the start of executing the thread cutting block
 0 : The signal is checked only when SAR, #0 of parameter 3708, is set.
 1 : The signal is always checked irrespective of whether SAR is set.

Note

When thread cutting blocks are consecutive, the spindle speed arrival signal is not checked for the second and subsequent thread cutting blocks.

SVD When the SIND signal is on, the detection of spindle speed fluctuation is:
 0 : Disabled
 1 : Enabled

	#7	#6	#5	#4	#3	#2	#1	#0
3709							MSI	SAM
							MSI	

[Data type] Bit

SAM The sampling frequency to obtain the average spindle speed
 0 : 4 (Normally, set to 0.)
 1 : 1

- MSI** In multi-spindle control, the SIND signal is valid
- 0 : Only when the first spindle is valid (SIND signal for the 2nd, 3rd spindle becomes ineffective)
 - 1 : For each spindle irrespective of whether the spindle is selected (Each spindle has its own SIND signal).

3730

Data used for adjusting the gain of the analog output of spindle speed

[Data type] Word**[Unit of data]** 0.1 %**[Valid data range]** 700 to 1250

Set data used for adjusting the gain of the analog output of spindle speed.

[Adjustment method]

- (1) Assign standard value 1000 to the parameter.
- (2) Specify the spindle speed so that the analog output of the spindle speed is the maximum voltage (10 V).
- (3) Measure the output voltage.
- (4) Assign the value obtained by the following equation to parameter No. 3730.

$$\text{Set value} = \frac{10 \text{ (V)}}{\text{Measured data (V)}} \times 1000$$

- (5) After setting the parameter, specify the spindle speed so that the analog output of the spindle speed is the maximum voltage. Confirm that the output voltage is 10V.

Note

This parameter needs not to be set for serial spindles.

3731

Compensation value for the offset voltage of the analog output of the spindle speed

[Data type] Word**[Unit of data]** Velo**[Valid data range]** -1024 to+1024

Set compensation value for the offset voltage of the analog output of the spindle speed.

$$\text{Set value} = -8191 \times \text{Offset voltage (V)} / 12.5$$

[Adjustment method]

- (1) Assign standard value 0 to the parameter.
- (2) Specify the spindle speed so that the analog output of the spindle speed is 0.
- (3) Measure the output voltage.
- (4) Assign the value obtained by the following equation to parameter No. 3731.

$$\text{Set value} = \frac{-8191 \times \text{Offset voltage (V)}}{12.5}$$

- (5) After setting the parameter, specify the spindle speed so that the analog output of the spindle speed is 0. Confirm that the output voltage is 0V.

Note
This parameter need not to be set for serial spindles.

3732	The spindle speed during spindle orientation or the spindle motor speed during spindle gear shift
------	---------------------------------------------------------------------------------------------------

[Data type] 2-word

[Valid data range] 0 to 20000

Set the spindle speed during spindle orientation or the spindle motor speed during gear shift.

When GST, #1 of parameter 3705, is set to 0, set the spindle speed during spindle orientation in rpm.

When GST, #1 of parameter 3705, is set to 1, set the spindle motor speed during spindle gear shift calculated from the following formula.

For a serial spindle

$$\text{Set value} = \frac{\text{Spindle motor speed during spindle gear shift}}{\text{Maximum spindle motor speed}} \times 16383$$

For an analog spindle

$$\text{Set value} = \frac{\text{Spindle motor speed during spindle gear shift}}{\text{Maximum spindle motor speed}} \times 4095$$

3735	Minimum clamp speed of the spindle motor
------	------------------------------------------

[Data type] Word

[Valid data range] 0 to 4095

Set the minimum clamp speed of the spindle motor.

$$\text{Set value} = \frac{\text{Minimum clamp speed of the spindle motor}}{\text{Maximum spindle motor speed}} \times 4095$$

3736	Maximum clamp speed of the spindle motor
------	------------------------------------------

[Data type] Word

[Valid data range] 0 to 4095

Set the maximum clamp speed of the spindle motor.

$$\text{Set value} = \frac{\text{Maximum clamp speed of the spindle motor}}{\text{Maximum spindle motor speed}} \times 4095$$

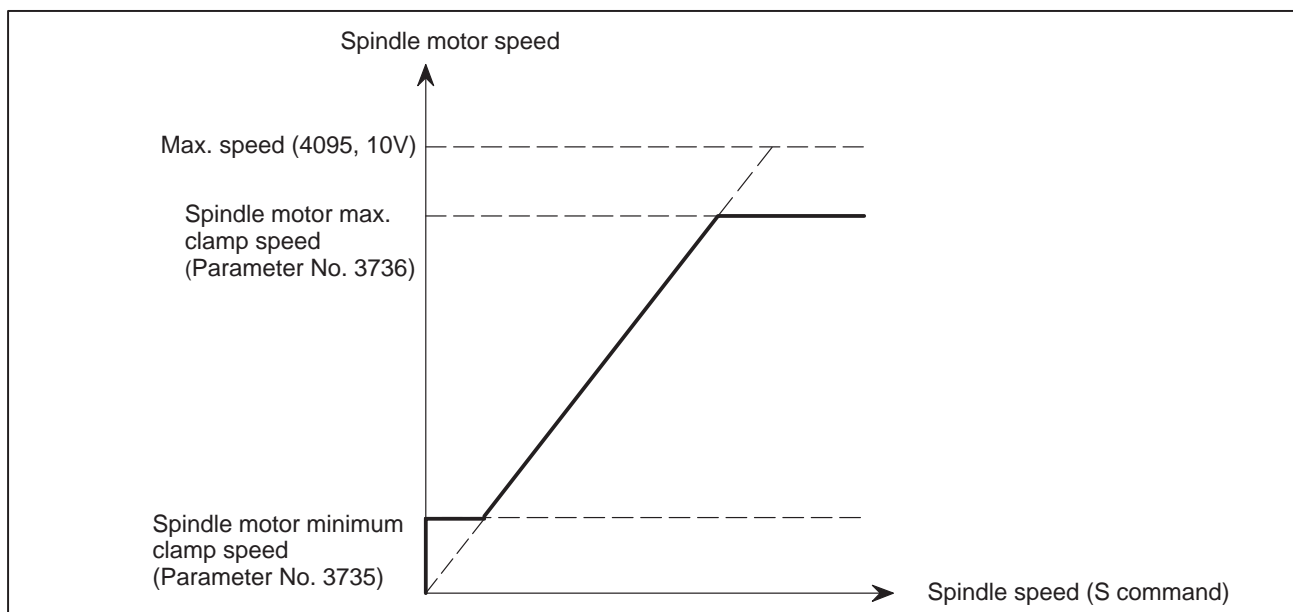

Fig.4.14 (a) Maximum Clamp Speed of Spindle Motor

3740	Time elapsed prior to checking the spindle speed arrival signal
------	-----------------------------------------------------------------

[Data type] Byte

[Unit of data] msec

[Valid data range] 0 to 225

Set the time elapsed from the execution of the S function up to the checking of the spindle speed arrival signal.

3741	Maximum spindle speed for gear 1
3742	Maximum spindle speed for gear 2
3743	Maximum spindle speed for gear 3
3744	Maximum spindle speed for gear 4

[Data type] Word

[Unit of data] rpm

[Valid data range] 0 to 32767

Set the maximum spindle speed corresponding to each gear.

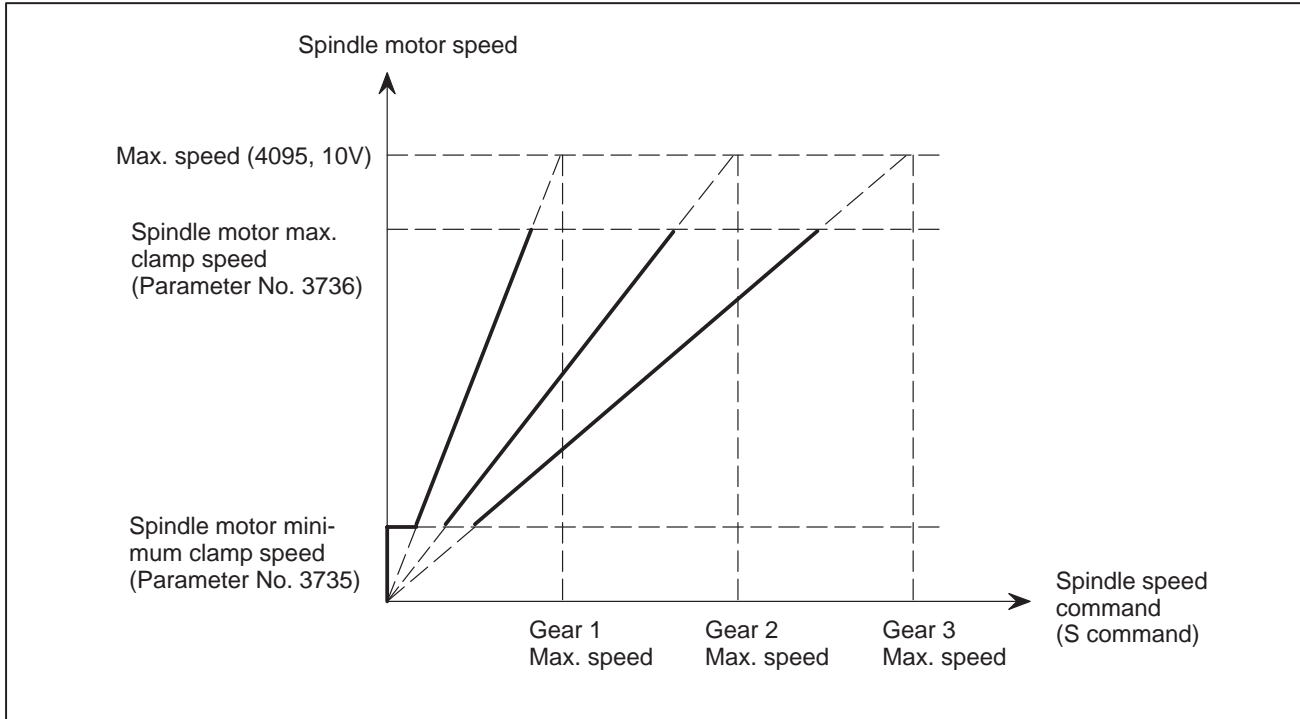

Fig.4.14 (b) Maximum Spindle Speed Corresponding to Gear 1/2/3

3751	Spindle motor speed when switching from gear 1 to gear 2
3752	Spindle motor speed when switching from gear 2 to gear 3

[Data type] Word

[Valid data range] 0 to 4095

For gear switching method B, set the spindle motor speed when the gears are switched.

$$\text{Set value} = \frac{\text{Spindle motor speed when the gears are switched}}{\text{Maximum spindle motor speed}} \times 4095$$

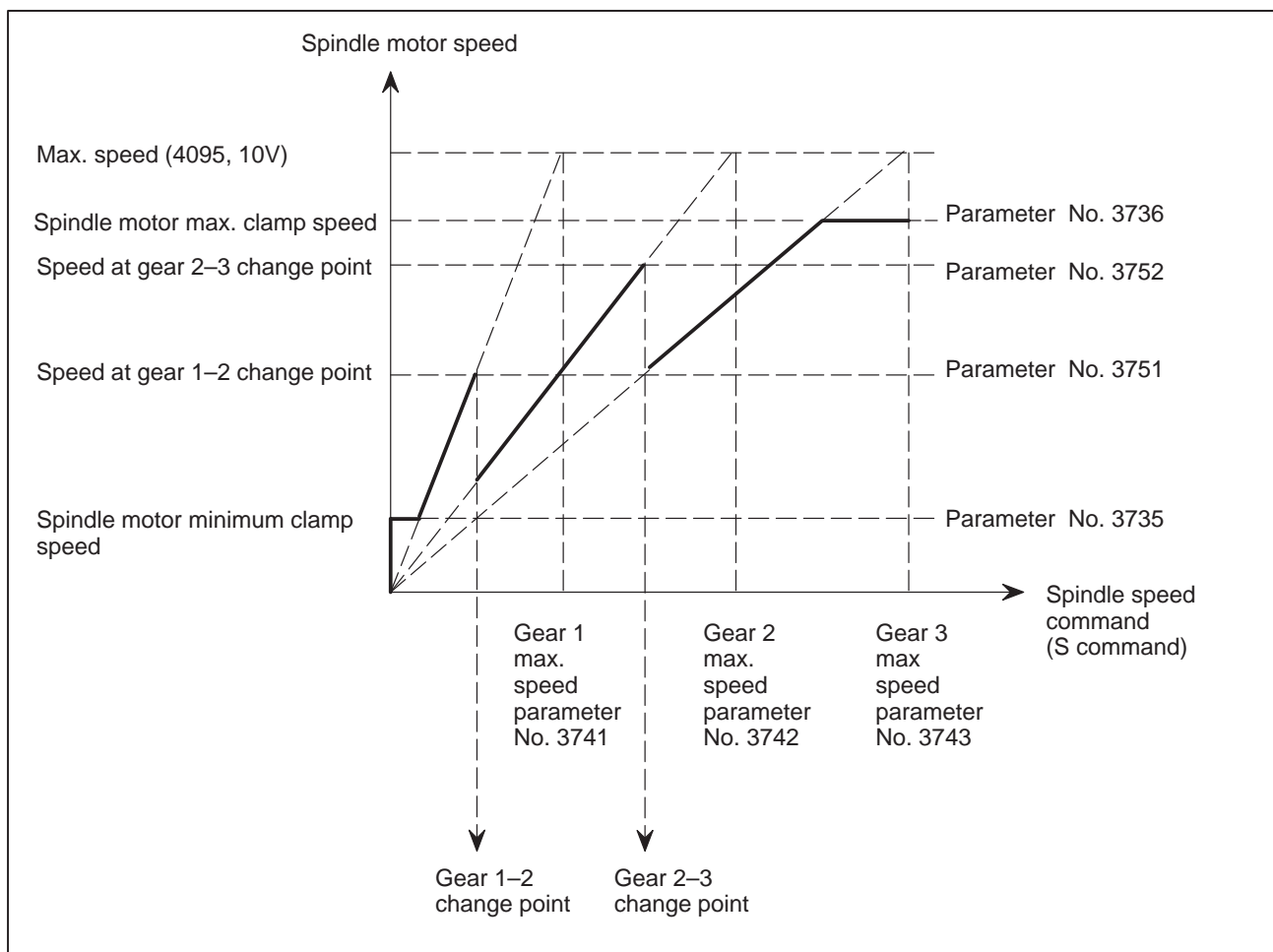

Fig.4.14 (c) Spindle Motor Speed at Gear 1-2/2-3 Change Point

3761	Spindle speed when switching from gear 1 to gear 2 during tapping
3762	Spindle speed when switching from gear 2 to gear 3 during tapping

[Data type] Word

[Unit of data] rpm

[Valid data range] 0 to 32767

When method B is selected (SGT,#3 of parameter 3705, is set to 1) for the tapping cycle gear switching method, set the spindle speed when the gears are switched.

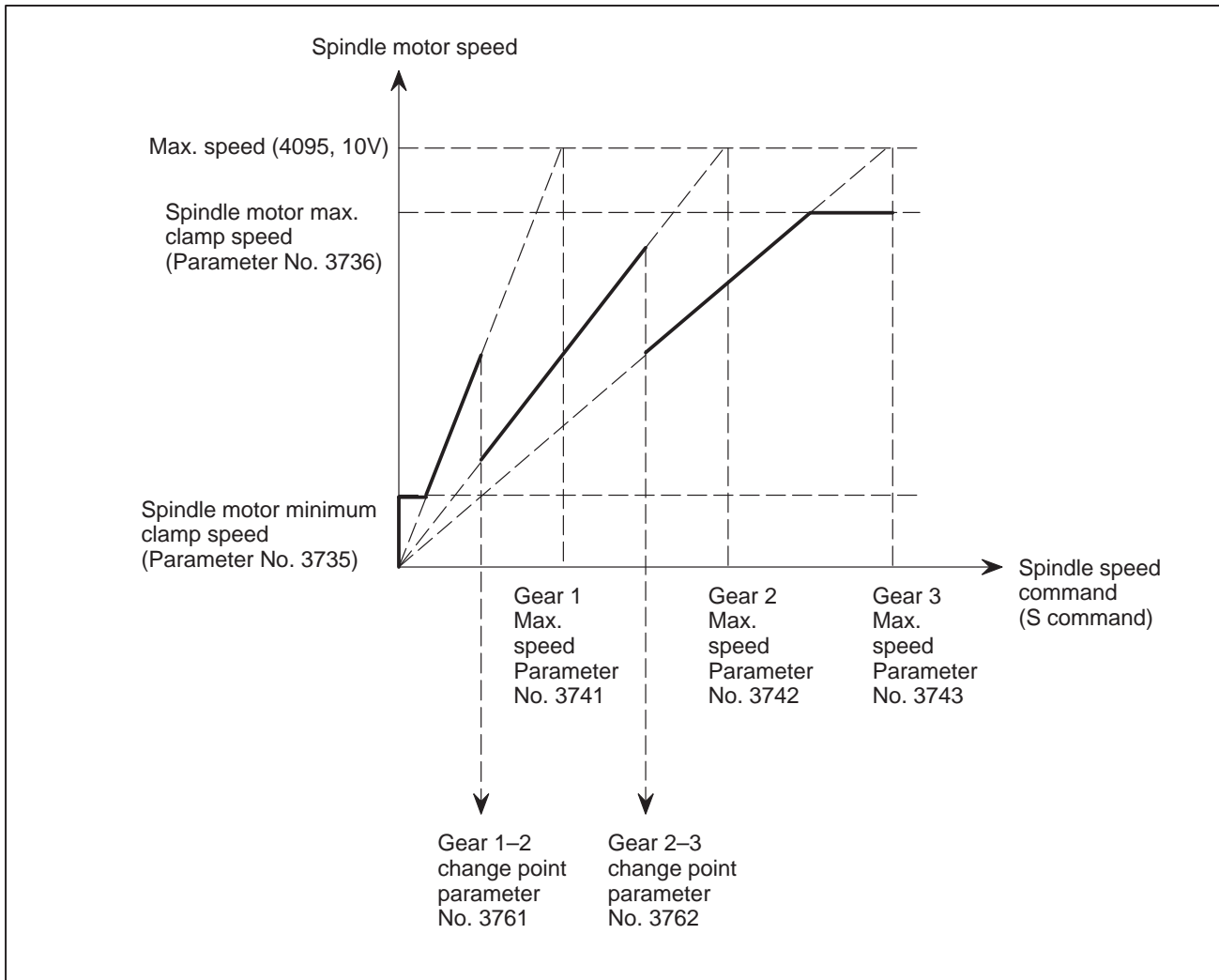

Fig.4.14 (d) Spindle Motor Speed at Gear 1-2/2-3 Change Point during Tapping

3770	Axis as the calculation reference in constant surface speed control
------	---------------------------------------------------------------------

[Data type] Byte

[Valid data range] 1, 2, 3, ..., number of control axes

Set the axis as the calculation reference in constant surface speed control.

Note

When 0 is set, constant surface speed control is always applied to the X-axis. In this case, specifying P in a G96 block has no effect on the constant surface speed control.

3771

Minimum spindle speed in constant surface speed control mode (G96)

[Data type] Word**[Unit of data]** rpm**[Valid data range]** 0 to 32767

Set the minimum spindle speed in the constant surface speed control mode (G96).

The spindle speed in constant surface speed control is clamped to the speed given by parameter 3771.

3772

Maximum spindle speed

[Data type] Word**[Unit of data]** rpm**[Valid data range]** 0 to 32767

This parameter sets the maximum spindle speed.

When a command specifying a speed exceeding the maximum speed of the spindle is specified, or the speed of the spindle exceeds the maximum speed because of the spindle speed override function, the spindle speed is clamped at the maximum speed set in the parameter.

Notes

- 1 In the M series, this parameter is valid when the constant surface speed control option is selected.
- 2 When the constant surface speed control option is selected, the spindle speed is clamped at the maximum speed, regardless of whether the G96 mode or G97 mode is specified.
- 3 When 0 is set in this parameter, the speed of the spindle is not clamped.
- 4 When spindle speed command control is applied using the PMC, this parameter has no effect, and the spindle speed is not clamped.
- 5 When the multi-spindle control option is selected (T series), set the maximum speed for each spindle in the following parameters:
 Parameter No. 3772: Sets the maximum speed for the first spindle.
 Parameter No. 3802: Sets the maximum speed for the second spindle.
 Parameter No. 3822: Sets the maximum speed for the third spindle.

3802

Maximum speed of the second spindle

[Data type] Word**[Unit of data]** rpm**[Valid data range]** 0 to 32767

Parameter sets the maximum speed for the second spindle.
 When a command specifying a speed exceeding the maximum speed of the spindle is specified, or the speed of the spindle exceeds the maximum speed because of the spindle speed override function, the spindle speed is clamped at the maximum speed set in the parameter.

Notes

- 1 This parameter is valid when the multi-spindle control option is selected.
- 2 When the constant surface speed control option is selected, the spindle speed is clamped at the specified maximum speed, regardless of whether the G96 mode or G97 mode is specified.
- 3 When 0 is set in this parameter, the setting of parameter No. 3772 for the first spindle is used.
 When 0 is set in parameter NO. 3772, the spindle speed is not clamped.
- 4 When spindle speed command control is applied using the PMC, this parameter has no effect, and the spindle speed is not clamped.

3811

Maximum spindle speed for gear 1 of the second spindle

3812

Maximum spindle speed for gear 2 of the second spindle

[Data type] Word

[Unit of data] rpm

[Valid data range] 0 to 32767

Set the maximum spindle speed for each gear of the second spindle.

Note

These parameters are used for the multi-spindle control.

3820

Data for adjusting the gain of the analog output of the third-spindle speed

[Data type] Word

[Unit of data] 0.1%

[Valid data range] 700 to 1250

Set the data used for adjusting the gain of the analog output of the third spindle speed.

Note

This parameter is used for controlling the multi-spindles.

3821

Offset-voltage compensation value of the analog output of the third-spindle speed

[Data type] Word

[Unit of data] Velo

[Valid data range] –1024 to 1024

Set the offset–voltage compensation value of the analog output of the third–spindle speed.

Note

This parameter is used for controlling the multi–spindles.

3822

Maximum speed of the third spindle

[Data type] Word

[Unit of data] rpm

[Valid data range] 0 to 32767

This parameter sets the maximum speed for the third spindle.

When a command specifying a speed exceeding the maximum spindle speed is specified, or the spindle speed exceeds the maximum speed because of the spindle speed override function, the spindle speed is clamped at the maximum speed set in the parameter.

Notes

- 1 This parameter is valid when the multi–spindle control option is selected.
- 2 When the constant surface speed control option is selected, the spindle speed is clamped at the specified maximum speed, regardless of whether the G96 mode or G97 mode is set.
- 3 When 0 is set in this parameter, the setting of parameter No. 3772 for the first spindle is used. When 0 is set in parameter No. 3772, the spindle speed is not clamped.
- 4 When spindle speed command control is applied using the PMC, this parameter has no effect, and the speed of the spindle is not clamped.

3831

Maximum spindle speed for gear 1 of the third spindle

3832

Maximum spindle speed for gear 2 of the third spindle

[Data type] Word

[Unit of data] rpm

[Valid data range] 0 to 32767

Set the maximum spindle speed for each gear of the third spindle.

Notes

These parameters are used for the multi–spindle control.

Table 4.14 (a) Parameters for Control of Serial Interface Spindle Cs Contouring Control Axis

No.	Data type	Description	
3900	Byte	First group for the first spindle	Number of the servo axis whose loop gain is to be changed according to the set values of parameters 3901 to 3904 when the Cs contouring axis is controlled (set values 0 to 8)
3901	Word		Loop gain for the servo axis when the Cs contouring axis is controlled for spindle gear 1 selection
3902	Word		Loop gain for the servo axis when the Cs contouring axis is controlled for spindle gear 2 selection
3903	Word		Loop gain for the servo axis when the Cs contouring axis is controlled for spindle gear 3 selection
3904	Word		Loop gain for the servo axis when the Cs contouring axis is controlled for spindle gear 4 selection
3910	Byte	Second group for the first spindle	Number of the servo axis whose loop gain is to be changed according to the set values of parameters 3911 to 3914 when the Cs contouring axis is controlled (set values 0 to 8)
3911	Word		Loop gain for the servo axis when the Cs contouring axis is controlled for spindle gear 1 selection
3912	Word		Loop gain for the servo axis when the Cs contouring axis is controlled for spindle gear 2 selection
3913	Word		Loop gain for the servo axis when the Cs contouring axis is controlled for spindle gear 3 selection
3914	Word		Loop gain for the servo axis when the Cs contouring axis is controlled for spindle gear 4 selection
3920	Byte	Third group for the first spindle	Number of the servo axis whose loop gain is to be changed according to the set values of parameters 3921 to 3924 when the Cs contouring axis is controlled (set values 0 to 8)
3921	Word		Loop gain for the servo axis when the Cs contouring axis is controlled for spindle gear 1 selection
3922	Word		Loop gain for the servo axis when the Cs contouring axis is controlled for spindle gear 2 selection
3923	Word		Loop gain for the servo axis when the Cs contouring axis is controlled for spindle gear 3 selection
3924	Word		Loop gain for the servo axis when the Cs contouring axis is controlled for spindle gear 4 selection

Table 4.14 (a) Parameters for Control of Serial Interface Spindle Cs Contouring Control Axis

No.	Data type	Description	
3930	Byte	Fourth group for the first spindle	Number of the servo axis whose loop gain is to be changed according to the set values of parameters 3931 to 3934 when the Cs contouring axis is controlled (set values 0 to 8)
3931	Word		Loop gain for the servo axis when the Cs contouring axis is controlled for spindle gear 1 selection
3932	Word		Loop gain for the servo axis when the Cs contouring axis is controlled for spindle gear 2 selection
3933	Word		Loop gain for the servo axis when the Cs contouring axis is controlled for spindle gear 3 selection
3934	Word		Loop gain for the servo axis when the Cs contouring axis is controlled for spindle gear 4 selection
3940	Byte	Fifth group for the first spindle	Number of the servo axis whose loop gain is to be changed according to the set values of parameters 3941 to 3944 when the Cs contouring axis is controlled (set values 0 to 8)
3941	Word		Loop gain for the servo axis when the Cs contouring axis is controlled for spindle gear 1 selection
3942	Word		Loop gain for the servo axis when the Cs contouring axis is controlled for spindle gear 2 selection
3943	Word		Loop gain for the servo axis when the Cs contouring axis is controlled for spindle gear 3 selection
3944	Word		Loop gain for the servo axis when the Cs contouring axis is controlled for spindle gear 4 selection

<Setting method>

First, select servo axes which perform interpolation with the Cs contouring axis. (Up to five axes can be selected.)

When there is no servo axis for interpolation with the Cs contouring axis, set the parameters 3900, 3910, 3920, 3930, and 3940 to 0 to terminate parameter setting.

When there are servo axes for interpolation with the Cs contouring axis, the parameters must be set according to the procedure below for each axis.

- (1) Set the number of a servo axis (1 to 8) for interpolation with the Cs contouring axis in parameters 39n0 (n = 0, 1, 2, 3, and 4).
- (2) Set loop gain values of the servo axis specified in (1) above which is used when the Cs contouring axis is controlled in parameters 39n1, 39n2, 39n3, and 39n4. (There are four stages for main gears used.)
- (3) When the number of specified servo axes is less than 5, set the remaining parameters (39n0) to 0 to terminate parameter setting. When the number of a Cs contouring axis is set to parameter 39n0, the parameter is assumed to be set to 0.

Note

The loop gain used for Cs contouring control is selected when the mode changes from the spindle mode to the Cs contouring axis control mode according to the gears set at this time.

If gears are switched in the Cs contouring axis control mode, the loop gain cannot be changed.

Table 4.14 (b) Parameters for Serial Interface Spindle Amplifier (α series, S series) (1/8)

No.	Data type	Description
4000	Bit	Bit parameter
4001	Bit	Bit parameter
4002	Bit	Bit parameter
4003	Bit	Bit parameter
4004	Bit	Bit parameter
4005	Bit	Bit parameter
4006	Bit	Bit parameter
4007	Bit	Bit parameter
4008	Bit	Bit parameter
4008	Bit	Bit parameter
4009	Bit	Bit parameter
4010	Bit	Bit parameter
4011	Bit	Bit parameter
4012	Bit	Bit parameter
4013	Bit	Bit parameter
4014	Bit	Bit parameter
4015	Bit	Bit parameter (Cannot be changed by the user. See Note 1.)
4016	Bit	Bit parameter
4017	Bit	Bit parameter
4018	Bit	Bit parameter
4019	Bit	Bit parameter (for setting parameters automatically. See Note 2.)
4020	Word	Maximum motor speed
4021	Word	Maximum speed when the C axis is controlled
4022	Word	Speed arrival detection level
4023	Word	Speed detection level
4024	Word	Speed zero detection level
4025	Word	Torque limit value
4026	Word	Load detection level 1
4027	Word	Load detection level 2
4028	Word	Output limit pattern
4029	Word	Output limit value
4030	Word	Soft start/stop time
4031	Word	Position coder method orientation stop position
4032	Word	Acceleration/deceleration time constant when the spindle synchronization is controlled
4033	Word	Arrival level for the spindle synchronization speed
4034	Word	Shift amount when the spindle phase synchronization is controlled
4035	Word	Spindle phase synchronization compensation data
4036	Word	Feed forward factor
4037	Word	Velocity loop feed forward factor
4038	Word	Orientation speed
4039	Word	Slip compensation gain

Table 4.14 (b) Parameters for Serial Interface Spindle Amplifier (α series, S series) (2/8)

No.	Data type	Description
4040	Word	Normal velocity loop proportional gain (HIGH)
4041	Word	Normal velocity loop proportional gain (LOW)
4042	Word	Velocity loop proportional gain during orientation (HIGH)
4043	Word	Velocity loop proportional gain during orientation (LOW)
4044	Word	Velocity loop proportional gain in servo mode/synchronous control (HIGH)
4045	Word	Velocity loop proportional gain in servo mode/synchronous control (LOW)
4046	Word	Velocity loop proportional gain when the C axis is controlled (HIGH)
4047	Word	Velocity loop proportional gain when the C axis is controlled (LOW)
4048	Word	Normal velocity loop integral gain (HIGH)
4049	Word	Normal velocity loop integral gain (LOW)
4050	Word	Velocity loop integral gain during orientation (HIGH)
4051	Word	Velocity loop integral gain during orientation (LOW)
4052	Word	Velocity loop integral gain in servo mode/synchronous control (HIGH)
4053	Word	Velocity loop integral gain in servo mode/synchronous control (LOW)
4054	Word	Velocity loop integral gain when the C axis is controlled (HIGH)
4055	Word	Velocity loop integral gain when the C axis is controlled (LOW)
4056	Word	Gear ratio (HIGH)
4057	Word	Gear ratio (MEDIUM HIGH)
4058	Word	Gear ratio (MEDIUM LOW)
4059	Word	Gear ratio (LOW)
4060	Word	Position gain during orientation (HIGH)
4061	Word	Position gain during orientation (MEDIUM HIGH)
4062	Word	Position gain during orientation (MEDIUM LOW)
4063	Word	Position gain during orientation (LOW)
4064	Word	Position gain change ratio when orientation is completed
4065	Word	Position gain in servo mode/synchronous control (HIGH)
4066	Word	Position gain in servo mode/synchronous control (MEDIUM HIGH)
4067	Word	Position gain in servo mode/synchronous control (MEDIUM LOW)
4068	Word	Position gain in servo mode/synchronous control (LOW)
4069	Word	Position gain when the C axis is controlled (HIGH)
4070	Word	Position gain when the C axis is controlled (MEDIUM HIGH)
4071	Word	Position gain when the C axis is controlled (MEDIUM LOW)
4072	Word	Position gain when the C axis is controlled (LOW)
4073	Word	Grid shift amount in servo mode
4074	Word	Reference position return speed in Cs contouring control mode or servo mode
4075	Word	Orientation completion signal detection level
4076	Word	Motor velocity limit value during orientation
4077	Word	Orientation stop position shift amount
4078	Word	MS signal constant = $(L/2)/(2 \times \pi \times H) \times 4096$
4079	Word	MS signal gain adjustment
4080	Word	Regenerative power limit
4081	Word	Delay time prior motor power shut-off
4082	Word	Acceleration/deceleration time setting
4083	Word	Motor voltage during normal rotation
4084	Word	Motor voltage during orientation
4085	Word	Motor voltage in servo mode/synchronous control
4086	Word	Motor voltage when the C axis is controlled
4087	Word	Over-speed detection level
4088	Word	Excessive velocity deviation detection level when the motor is constrained
4089	Word	Excessive velocity deviation detection level when the motor is rotated

Table 4.14 (b) Parameters for Serial Interface Spindle Amplifier (α series, S series) (3/8)

No.	Data type	Description
4090	Word	Overload detection level
4091	Word	Position gain change ratio when returning to the origin in the servo mode
4092	Word	Position gain change ratio when returning to the origin in C axis control
4093	Word	Reserved
4094	Word	Disturbance torque compensation constant (Acceleraton feedback gain)
4095	Word	Speed meter output voltage adjustment value
4096	Word	Load meter output voltage adjustment value
4097	Word	Spindle velocity feedback gain
4098	Word	Maximum speed at which position coder signal can be detected
4099	Word	Delay time for energizing the motor
4100	Word	Base velocity of the motor output specification
4101	Word	Limit value for the motor output specification
4102	Word	Base speed
4103	Word	Magnetic flux weakening start velocity
4104	Word	Current loop proportional gain during normal operation
4105	Word	Current loop proportional gain when the C axis is controlled
4106	Word	Current loop integral gain during normal operation
4107	Word	Current loop integral gain when the C axis is controlled
4108	Word	Zero point of current loop integral gain
4109	Word	Current loop proportional gain velocity factor
4110	Word	Current conversion constant
4111	Word	Secondary current factor for exciting current
4112	Word	Current expectation constant
4113	Word	Slip constant
4114	Word	High-speed rotation slip compensation constant
4115	Word	Compensation constant of voltage applied to motor in the dead zone
4116	Word	Electromotive force compensation constant
4117	Word	Electromotive force phase compensation constant
4118	Word	Electromotive force compensation velocity factor
4119	Word	Time constant of voltage filter for electromotive force compensation
4120	Word	Dead zone compensation data
4121	Word	Time constant for changing the torque
4122	Word	Velocity filter
4123	Word	Overload detection time setting
4124	Word	Voltage compensation factor during deceleration
4125	Word	Timer during automatic running
4126	Word	Velocity command during automatic running
4127	Word	Load meter displayed value for maximum output
4128	Word	Maximum output zero point
4129	Word	Secondary current factor during rigid tapping
4130	Word	Constant for compensating for the phase of the electromotive force at deceleration
4131	Word	Time constant of the speed detection filter at the Cs contour control
4132	Word	Conversion constant of the phase-V current
4133	Word	Motor model code
4134	2-Word	Reserved
4135	2-Word	Grid shift amount when the C axis is controlled
4136	Word	Motor voltage during normal rotation
4137	Word	Motor voltage in the servo mode/synchronous control mode
4138	Word	Base speed of the motor output specifications
4139	Word	Limit value for the motor output specifications

Table 4.14 (b) Parameters for Serial Interface Spindle Amplifier (α series, S series) (4/8)

No.	Data type	Description
4140	Word	Base speed
4141	Word	Magnetic flux weakening start velocity
4142	Word	Current loop proportional gain during normal operation
4143	Word	Current loop integral gain during normal operation
4144	2-word	Zero point of the current loop integral gain
4145	2-word	Velocity factor of the current loop proportional gain
4146	Word	Current conversion constant
4147	Word	Secondary current factor for activating current
4148	Word	Current expectation constant
4149	Word	Slip constant
4150	Word	High-speed rotation slip compensation constant
4151	Word	Compensation constant for voltage applied to motor in the dead zone
4152	Word	Electromotive force compensation constant
4153	Word	Electromotive force phase compensation constant
4154	Word	Velocity factor of the electromotive force compensation
4155	Word	Voltage compensation factor during deceleration
4156	Word	Slip compensation gain
4157	Word	Time constant for changing the torque
4158	Word	Maximum output zero point
4159	Word	Secondary current factor during rigid tapping
4160	Word	Hysteresis of the speed detection level
4161	Word	Constant for compensating for the phase of the electromotive for at deceleration
4162	Word	Velocity loop integral gain (HIGH) in Cs contour control cutting feed
4163	Word	Velocity loop integral gain (LOW) in Cs contour control cutting feed
4164	Word	Conversion constant of phase-V current
4165	Word	Time constant of voltage filter for eletromotive force compensation
4166	Word	Regenerative power limit
4167	Word	Reserved
4168	Word	Overload current alarm detection level (for low speed characteristic)
4169	Word	Overload current alarm detection time constant
4170	Word	Overload current alarm detection level (for high speed characteristic)
4171	Word	Arbitrary gear data between spindle and Position coder (HIGH no. of teeth on the spindle)
4172	Word	Arbitrary gear data between spindle and position coder (HIGH no. of teeth on PC)
4173	Word	Arbitrary gear data between spindle and position coder (LOW no. of teeth on spindle)
4174	Word	Arbitrary gear data between spindle and position coder (LOW no. of teeth on PC)
4175	Word	Delay timer at ON of electromagnetic contactor in unit (S series) Spindle analog override zero level (α series)
4176	Bit	Bit parameter
4177	Bit	Bit parameter
4178	Bit	Bit parameter
4179	Bit	Bit parameter
4180	Bit	Bit parameter
4181	Bit	Bit parameter
4182	Bit	Bit parameter
4183	Bit	Bit parameter
4184	Bit	Bit parameter
4185	Bit	Bit parameter
4186	Bit	Bit parameter
4187	Bit	Bit parameter
4188	Bit	Bit parameter
4189	Bit	Bit parameter

Table 4.14 (b) Parameters for Serial Interface Spindle Amplifier (α series, S series) (5/8)

No.	Data type	Description
4190	Bit	Bit parameter
4192	Bit	Bit parameter
4193	Bit	Bit parameter
4194	Bit	Bit parameter
4195	Bit	Bit parameter
4196	Bit	Maximum motor speed
4197	Bit	Reached speed level
4198	Bit	Speed detection level
4199	Bit	Speed zero detection level
4200	Word	Torque limit value
4201	Word	Load detection level 1
4202	Word	Output limit pattern
4203	Word	Output limit value
4204	Word	Position coder method orientation stop position
4205	Word	Orientation speed
4206	Word	Proportional gain (HIGH) of the normal velocity loop
4207	Word	Proportional gain (LOW) of the normal velocity loop
4208	Word	Velocity loop proportional gain during orientation (HIGH)
4209	Word	Velocity loop proportional gain during orientation (LOW)
4210	Word	Velocity loop proportional gain in the servo mode (HIGH)
4211	Word	Velocity loop proportional gain in the servo mode (LOW)
4212	Word	Normal velocity loop integral gain
4213	Word	Velocity loop integral gain during orientation
4214	Word	Velocity loop integral gain in the servo mode (HIGH)
4215	Word	Reserved
4216	Word	Gear ratio (HIGH)
4217	Word	Gear ratio (LOW)
4218	Word	Position gain during orientation (HIGH)
4219	Word	Position gain during orientation (LOW)
4220	Word	Position gain change ratio when orientation is completed
4221	Word	Position gain in the servo mode (HIGH)
4222	Word	Position gain in the servo mode (LOW)
4223	Word	Grid shift amount in the servo mode
4224	Word	Reserved
4225	Word	Reserved
4226	Word	Detection level of orientation completion signal
4227	Word	Motor velocity limit value during orientation
4228	Word	Shift amount of orientation stop position
4229	Word	MS signal constant = $(L/2)/(2 \times \pi \times H) \times 4096$
4230	Word	MS signal gain adjustment
4231	Word	Regenerative power limit
4232	Word	Delay time up to motor power shut-off
4233	Word	Acceleration/deceleration time setting
4234	Word	Spindle load monitor observer gain 1
4235	Word	Spindle load monitor observer gain 2
4236	Word	Motor voltage during normal rotation
4237	Word	Motor voltage during orientation
4238	Word	Motor voltage in the servo mode
4239	Word	Position gain change ratio when returning to the origin in the servo mode

Table 4.14 (b) Parameters for Serial Interface Spindle Amplifier (α series, S series) (6/8)

No.	Data type	Description
4240	Word	Feed forward coefficient
4241	Word	Feed forward coefficient in velocity loop
4242	Word	Reserved
4243	Word	Arbitrary gear data between spindle and position coder (SUB/HIGH no. of teeth on spindle)
4244	Word	Arbitrary gear data between spindle and position coder (SUB/HIGH no. of teeth on PC)
4245	Word	Arbitrary gear data between spindle and position coder (SUB/LOW no. of teeth on spindle)
4246	Word	Arbitrary gear data between spindle and position coder (SUB/LOW no. of teeth on PC)
4247	Word	Word Spindle load monitor magnetic flux compensation time constant (for high-speed characteristic on the MAIN side)
4248	Word	Word Spindle load motor torque constant (for high-speed characteristic on the MAIN side)
4249	Word	Word Spindle load monitor observer gain 1 (on the MAIN side)
4250	Word	Word Spindle load monitor observer gain 2 (on the MAIN side)
4251	Word	Word Spindle load monitor magnetic flux compensation time constant (for low-speed characteristic on the MAIN side)
4252	Word	Word Spindle load monitor magnetic flux compensation time constant (for high-speed characteristic)
4253	Word	Word Spindle load monitor magnetic flux compensation time constant (for low-speed characteristic)
4254	Word	Word Slip correction gain (for high-speed characteristic)
4255	Word	Word Slip correction gain (for low-speed characteristic)
4256	Word	Base velocity of the motor output specifications
4257	Word	Limit value for the motor output specifications
4258	Word	Base speed
4259	Word	Magnetic flux weakening start velocity
4260	Word	Current loop proportional gain during normal operation
4261	Word	Current loop integral gain during normal operation
4262	Word	Zero point of current loop integral gain
4263	Word	Velocity factor of current loop proportional gain
4264	Word	Current conversion constant
4265	Word	Secondary current factor for excitation current
4266	Word	Current expectation constant
4267	Word	Slip constant
4268	Word	Compensation constant for high-speed rotation slip
4269	Word	Compensation constant for voltage applied to motor in the dead zone
4270	Word	Electromotive force compensation constant
4271	Word	Phase compensation constant of electromotive force
4272	Word	Compensation velocity factor for electromotive force
4273	Word	Time constant for changing the torque
4274	Word	Displayed value of load meter for maximum output
4275	Word	Maximum output zero point
4276	Word	Secondary current factor in rigid tapping
4277	Word	Constant for compensating for the phase of the electromotive force at deceleration
4278	Word	Time constant of the speed detection filter
4279	Word	Reserved

Table 4.14 (b) Parameters for Serial Interface Spindle Amplifier (α series, S series) (7/8)

No.	Data type	Description
4280	Word	Time constant of voltage filter for electromotive force compensation
4281	Word	Word Spindle load monitor torque constant (for low-speed characteristic on the MAIN side)
4282	Word	Word Spindle load monitor torque constant (for high-speed characteristic)
4283	Word	Word Spindle load monitor torque constant (for low-speed characteristic)
4284	Word	Motor voltage during normal rotation
4285	Word	Motor voltage in the servo mode
4286	Word	Base speed of the motor output specifications
4287	Word	Limit value for the motor output specifications
4288	Word	Base speed
4289	Word	Magnetic flux weakening start velocity
4290	Word	Current loop proportional gain during normal operation
4291	Word	Current loop integral gain during normal operation
4292	Word	Zero point of current loop integral gain
4293	Word	Velocity factor of current loop proportional gain
4294	Word	Current conversion constant
4295	Word	Secondary current factor for excitation current
4296	Word	Current expectation constant
4297	Word	Slip constant
4298	Word	Compensation constant for high-speed rotation slip
4299	Word	Compensation constant for voltage applied to motor in the dead zone
4300	Word	Electromotive force compensation constant
4301	Word	Phase compensation constant for electromotive force
4302	Word	Compensation velocity factor for electromotive force
4303	Word	Time constant for changing the torque
4304	Word	Maximum output zero point
4305	Word	Secondary current factor in rigid tapping
4306	Word	Constant for compensating for the phase of the electromotive force at deceleration
4307	Word	Limit of regenerative power
4308	Word	Time constant of voltage filter for electromotive voltage compensation
4309	Word	Motor model code
4310	2-word	Reserved
4311	2-word	Reserved
4312	Word	Position coder method orientation end signal width 2 (MAIN)
4313	Word	Magnetic sensor method orientation end signal width 1 (MAIN)
4314	Word	Magnetic sensor method orientation end signal width 2 (MAIN)
4315	Word	Magnetic sensor method orientation stop position shift amount (MAIN)
4316	Word	Position coder method orientation end signal width 2 (SUB)
4317	Word	Magnetic sensor method orientation end signal width 1 (SUB)
4318	Word	Magnetic sensor method orientation end signal width 2 (SUB)
4319	Word	Magnetic sensor method orientation stop position shift amount (SUB)
4320	Word	Spindle orientation deceleration constant (MAIN/HIGH)
4321	Word	Spindle orientation deceleration constant deceleration (MAIN/MEDIUM HIGH)
4322	Word	Spindle orientation deceleration constant deceleration (MAIN/MEDIUM LOW)
4323	Word	Spindle orientation deceleration constant deceleration (MAIN/LOW)
4324	Word	Spindle orientation deceleration constant deceleration (SUB/HIGH)
4325	Word	Spindle orientation deceleration constant deceleration (SUB/LOW)
4326	Word	Width of pulses when switching to the spindle orientation control mode (MAIN)
4327	Word	Width of pulses when switching to the spindle orientation control mode (SUB)
4328	Word	Word Position coder-based spindle orientation command multiplication (MAIN)
4329	Word	Word Position coder-based spindle orientation command multiplication (SUB)

Table 4.14 (b) Parameters for Serial Interface Spindle Amplifier (α series, S series) (8/8)

No.	Data type	Description
4330	Word	Word Motor excitation delay time at spindle orientation (MAIN)
4331	Word	Word Motor excitation delay time at spindle orientation (SUB)
4332	Word	Reserved
4333	Word	Reserved
4334	Word	No. of arbitrary pulses of speed detector (MAIN)
4335	Word	No. of arbitrary pulses of speed detector (SUB)
4336	Word	Magnetic flux change point for spindle synchronus acc./dec/ time calculation.
4337	Word	Velocity compensation factor of velocity loop gain (MAIN)
4338	Word	Velocity compensation factor of velocity loop gain (SUB)
4339	Word	Word Torque clamp level
4340	Word	Word Bell-shaped acceleration/deceleration time constant for spindle synchronization
4341	Word	Word Abnormal load detection level
4342	Word	Reserved
4343	Word	N pulse suppress
4344	Word	Look-ahead feed forward coefficient
4345	Word	Word Spindle motor speed command detection level
4346	Word	Incomplete integral coefficient
4347	Word	Word Detection level for spindle 1-to-2 speed difference at slave operation
4348	Word	Overload current alarm detection level (for low speed characteristic)
4349	Word	Overload current alarm detection time constant
4350	Word	Overload current alarm detection level (for high speed characteristic)
4351	Word	Compensation for current detection offset

Notes on parameters of the spindle amplifier with the serial interface

Notes

- 1 Among the parameters of the spindle amplifier with the serial interface, parameters Nos. 4015 and 4191 cannot be changed by the users.
These parameters require to assign optional software to the CNC and are automatically set depending on the type of the software.
- 2 To set the parameters of the spindle amplifier with the serial interface automatically, set #7 of parameter No. 4019 (if the sub spindle is set in the CNC with the spindle switching function, use parameter No. 4195) to 1, assign the model code of the motor to be used to parameter No. 4133 (if the sub spindle is set in the CNC with the spindle switching function, use parameter No. 4309), turn off the power of the CNC and spindle amplifier, and restart the CNC and spindle amplifier.
- 3 Parameters No. 4000 to No. 4351 are used in the processing on the spindle amplifier. See FANUC AC SPINDLE MOTOR α series PARAMETER MANUAL (B-65150E) and FANUC AC SPINDLE SERVO UNIT serial interface S series MAINTENANCE MANUAL (B-65045E).
- 4 The CNC can control up to two spindle amplifier with the serial interface.
Up to three spindle amplifiers can be controlled in the Series 16 performing single-path control. When the spindle control amplifier provides the spindle switching function, one spindle amplifier can control two spindle motors using the switching function.
The output switching function can be used in spindle motors to be connected.
Up to four spindles, or eight types, (or, for the Series 16 performing single-path control, up to six spindles, or 12 types) can be used by switching the spindle motors. (The number of spindles that can controlled simultaneously is the same as the number of spindle amplifiers, that is two spindles (or, for the Series 6 performing single-path control, three spindles).)
Parameters of the spindle amplifier with the serial interface correspond to the above functions as follows:
 - (1) Parameter No. 4000 to No. 4351 "S1": First spindle amplifier
Parameter No. 4000 to No. 4351 "S2": Second spindle amplifier
Parameter No. 4000 to No. 4351 "S3": Third spindle amplifier
 - (2) Parameter No. 4000 to No. 4175 "S1"/"S2"/"S3": When the spindle switching function is not provided, or for the main spindle in the spindle amplifier when the function is provided.
Parameter No. 4176 to No. 4351 "S1"/"S2"/"S3": For the sub spindle in the spindle amplifier when the spindle switching function is provided.
 - (3) Parameters at low speed when the output switching function is provided.
Parameters No. 4136 to No. 4175 "S1"/"S2"/"S3": When the spindle switching function is not provided, or for the main spindle when the function is provided.
Parameters No. 4284 to No.4351 "S1"/"S2"/"S3": For the sub spindle when the spindle switching function is provided.
- 5 The CNC stores the parameters of the spindle amplifier with the serial interface. The CNC sends them to the spindle amplifier at the system power on and they are used in the unit. These parameters are sent from the CNC to the spindle amplifier in a batch when:
 - The CNC is switched on.
 - The serial spindle is restarted by a reset that is carried out after spindle communication alarm 749 occurs (because the spindle control unit is switched off or because of noise).
 If these parameters are rewritten, they are sent from the CNC to the spindle amplifier sequentially when:
 - The parameters have been entered from the MDI.
 - The parameters have been entered as programmable (G10).
 - The parameters have been entered via the reader/punch interface.

Notes

To set parameters automatically, upload parameters corresponding to the motor model from the spindle amplifier to the CNC prior to the procedure specified above.

The parameters of the spindle amplifier with serial interface can be changed after the system starts. Changing the parameters (No. 4000 to No. 4351 “S1”, “S2”, “S3”) in the CNC sends them to the spindle amplifier at an appropriate time and the parameters in the unit are updated. Be careful not to change parameters incorrectly.

4345

Serial spinsle motor detection speed

[Data type] Word type

[Unit of data] rpm

[Valid data range] 0 to 32767

S1 : for First spindle / S2 : for Second spindle / S3 : for Third spindle

This parameter sets the serial spindle motor speed at which the motor speed detection signal is output. The speeds of the serial spindle motors for the first, second, and third spindles are monitored, and the motor speed detection signal, indicating whether the speed of each spindle exceeds the value set in this parameter, is output to the Y address specified with parameter No. 1891.

Notes

- 1 The motor speed detection signals are not output when the servo/spindle motor speed detection function is not used, or 0 is set for this parameter.
- 2 For this parameter, set a motor speed rather than a spindle speed.

	#7	#6	#5	#4	#3	#2	#1	#0
4800							ND2	ND1

Note

When this parameter is set, the power must be turned off before operation is continued.

[Data type] Bit type

ND1 In controlling the spindle synchronization, the direction of the first spindle (master spindle) motor rotation is:

0 : The direction indicated by the command sign

1 : The opposite direction to that indicated by the command sign

ND2 In controlling the spindle synchronization, the direction of the 2nd spindle (slave spindle) motor rotation is:

0 : The direction indicated by the command sign

1 : The opposite direction to that indicated by the command sign

4810	Error pulse between two spindles when synchronizing phases in the serial spindle synchronization control mode
------	---------------------------------------------------------------------------------------------------------------

[Data type] Byte type

[Unit of data] Pulse

[Valid data range] 0 to 255

Set the difference in error pulses between two spindles when synchronizing phases in the serial spindle synchronization control mode. When the difference in error pulse between two spindles is within the value set in this parameter, the spindle phase synchronization completion signal FSPPH <F044#3> becomes “1”.

This parameter is used to check the difference in phase in synchronization control and to confirm the completion of synchronization in the serial spindle synchronization control mode.

4811	Allowable error count for the error pulses between two spindles in the serial spindle synchronization control mode or simple synchronous control mode
------	-------------------------------------------------------------------------------------------------------------------------------------------------------

[Data type] Word type

[Unit of data] Pulse

[Valid data range] 0 to 32767

Set the allowable error count for the error pulses between two spindles in the serial spindle synchronization control mode or simple synchronous control mode.

Note

This parameter is used to output the inter-spindle phase error detection signal SYCAL in the serial spindle synchronization control mode. The SYCAL <F044#4> signal becomes “1” when a phase error exceeding the value set in this parameter is found. When you are going to use this parameter to detect error pulses during simplified synchronization control, pay attention to the mode of the spindle, and set the parameter as required. (The parameter is invalid in spindle mode. It is valid in Cs contour control, rigid tapping, and spindle positioning mode; the detection unit per pulse differs, however.)

4900	#7	#6	#5	#4	#3	#2	#1	#0
								FLR

[Data type] Bit

FLR When the spindle speed fluctuation detection function is used, the rates of allowance (q) and fluctuation (r) those are set in parameter No. 4911 and No. 4912, respectively are set in steps of:
 0 : 1%
 1 : 0.1%

4911

Rapid (q) of the fluctuation of spindle speed which is assumed to be the specified spindle speed

[Data type] Word type**[Unit of data]**

Unit of data	1%	0.1% (T series)
---------------------	----	-----------------

[Valid data range]

Data range	1 – 100	1 – 1000
-------------------	---------	----------

Note

Unit of data depends on parameter No. 4900#0 FLR (T series only)

Set the ratio (q) of the spindle speed which is assumed to be the specified spindle speed in the spindle speed fluctuation detection function.

Let the commanded speed be S_c . When the actual spindle speed reaches between $(S_c - S_q)$ and $(S_c + S_q)$, it is assumed to be the commanded speed. The spindle speed fluctuation detection starts.

where, $S_q = S_c \times \frac{q}{100}$

4912

Spindle speed fluctuation ratio (r) for which no alarm is activated in the spindle speed fluctuation detection function

[Data type] Word**[Unit of data]**

Unit of data	1%	0.1% (T series)
---------------------	----	-----------------

[Valid data range]

Data range	1 – 100	1 – 1000
-------------------	---------	----------

Note

Unit of data depends on parameter No. 4900#0 FLR (T series only).

Set the spindle speed fluctuation ratio (r) for which no alarm is activated in the spindle speed fluctuation detection function (see Fig.4.14 (e)).

4913

Spindle speed fluctuation value (d) for which no alarm is activated in the spindle speed fluctuation detection function

[Data type] Word**[Unit of data]** rpm**[Valid data range]** 0 to 32767

Set the allowable fluctuation speed (S_d) for which no alarm is activated in the spindle speed fluctuation detection function.

The function for detecting spindle speed fluctuation checks whether the actual speed varies for the specified speed or not. S_d or S_r , whichever is greater, is taken as the allowable fluctuation speed (S_m). An alarm is activated when the actual spindle speed varies for the commanded speed (S_c) under the condition that the variation width exceeds the allowable variation width (S_m).

Sd: The allowable constant variation width which is independent of the specified spindle speed (Sd is set with parameter 4913.)

Sr: The allowable variation width which is obtained by multiplying Sc (commanded spindle speed) by r (constant ratio). (r is set with parameter 4912.)

Sm: Sd or Sr, whichever is greater

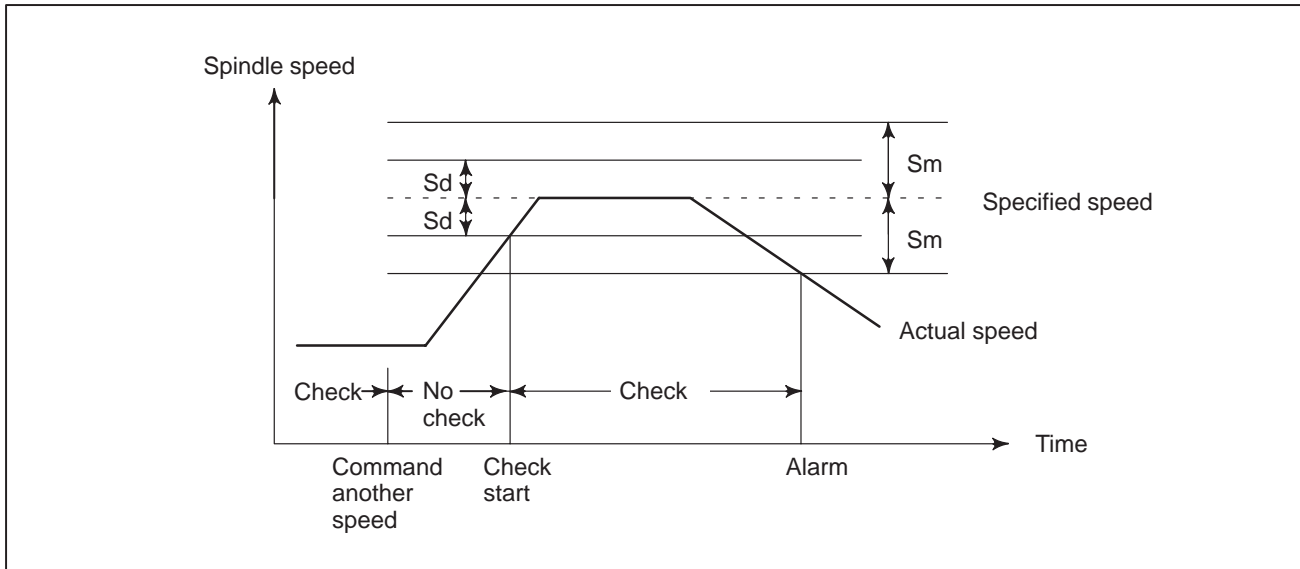

Fig.4.14 (e) Sd and Sm

4914

Time (p) elapsed from when the commanded spindle speed is changed to the start of spindle speed fluctuation detection

[Data type] 2-word

[Unit of data] ms

[Valid data range] 0 to 999999

Set the time elapsed from when the specified spindle speed is changed to the start of spindle speed fluctuation detection in the spindle speed fluctuation detection function. That is, the fluctuation in the spindle speed is not detected until the specified time elapses from when the specified spindle speed is changed.

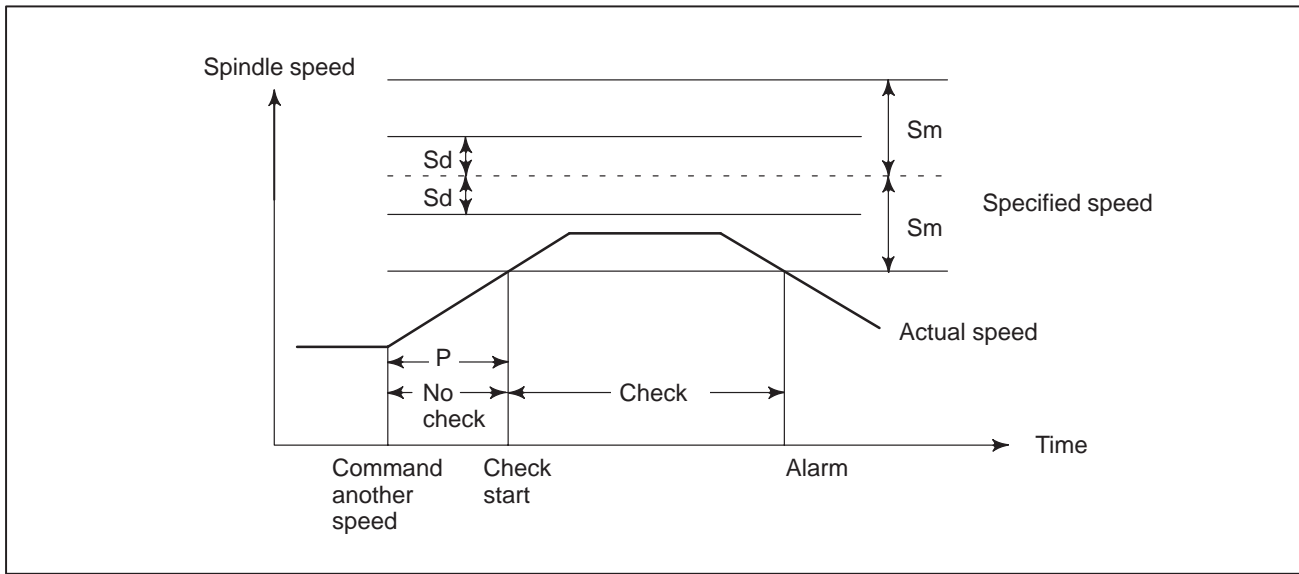

Fig.4.14 (f) Sd and Sm

	#7	#6	#5	#4	#3	#2	#1	#0
4950	IMB	ESI				ISZ	IDM	IOR

[Data type] Bit

IOR Resetting the system in the spindle positioning mode

- 0 : Does not releases the mode.
- 1 : Releases the mode

IDM The positioning direction for the spindle using a M code is

- 0 : The positive direction
- 1 : The negative direction

ISZ When an M code for spindle orientation is specified in spindle positioning:

- 0 : The spindle rotation mode is cleared and the mode is switched to the spindle positioning mode, and spindle orientation operation is performed.
- 1 : The spindle rotation mode is cleared and the mode is switched to the spindle positioning mode but spindle orientation operation is not performed.

ESI Selection of a spindle positioning specification

- 0 : The conventional specifaion is used.
- 1 : The extended specifaion is used.

Notes

The extended specification includes the following two extensions:

- (1) With the conventional specification, the number of M codes for specifying a spindle positioning angle is always 6. With the extended specification, an arbitrary number of such M codes from 1 to 256 can be selected by parameter setting (See parameter No. 4964.)
- (2) The maximum feedrate for spindle positioning (setting of parameter No. 1420) can be extended from 240000 to 269000 (in increments of 10 deg/min).

IMB When the spindle positioning function is used, half-fixed angle positioning based on M codes uses:

0 : Specification A

1 : Specification B

Note

In the case of half-fixed angle positioning based on M codes, three types of spindle positioning operations can occur:

- (1) The spindle rotation mode is cleared, then the mode is switched to the spindle positioning mode.
- (2) Spindle positioning is performed in the spindle positioning mode.
- (3) The spindle positioning mode is cleared, then the mode is switched to the spindle rotation mode.

In the case of specification A:

Operations (1) to (3) are specified using separate M codes.

- (1) Specified using M codes for performing spindle orientation. (See parameter No. 4960)
- (2) Specified using M codes for specifying a spindle positioning angle. (See parameter No. 4962)
- (3) Specified using M codes for clearing spindle positioning operation. (See parameter No. 4961.)

In the case of specification B:

When M codes for specifying a spindle positioning angle are specified, operations (1) to (3) are performed successively. (See parameter No. 4962.)

4960

M code specifying the spindle orientation

[Data type] Word

[Unit of data] Integer

[Valid data range] 6 to 97

Set an M code to change the spindle rotating mode to the spindle positioning mode. Setting the M code performs the spindle orientation. Spindle positioning can be specified from the next block.

4961

M code releasing the spindle positioning mode

[Data type] Word**[Unit of data]** Integer**[Valid data range]** 6 to 97

Set the M code to release the spindle positioning mode and to change the mode to the spindle rotating mode.

4962

M code for specifying a spindle positioning angle

[Data type] Word**[Unit of data]** Integer**[Valid data range]** 6 to 92

Two methods are available for specifying spindle positioning. One method uses address C for arbitrary-angle positioning. The other use an M code for half-fixed angle positioning. This parameter sets an M code for the latter method.

- When bit 6 (ESI) of parameter No. 4950=0
Six M code from $M \alpha$ to $M(\alpha+5)$ are used for half-fixed angle positioning, when α is the value of this parameter.
- When bit 6(ESI) of parameter No. 4950=1
Set the start M code in this parameter, and set the number of M codes in parameter No. 4964. Then β M codes from $M\alpha$ to $M(\alpha+\beta-1)$ are used for half fixed angle positioning.

The table below indicates the relationship between the M codes and positioning angles.

M code	Positioning angle	Example: Positioning angle when $\theta = 30^\circ$
$M\alpha$	θ	30°
$M (\alpha+1)$	2θ	60°
$M (\alpha+2)$	3θ	90°
$M (\alpha+3)$	4θ	120°
$M (\alpha+4)$	5θ	150°
$M (\alpha+5)$	6θ	180°
\vdots	\vdots	\vdots
$M (\alpha+n)$	$(n+1) \theta$	

Note

θ represents the basic angular displacement set in parameter No. 4963.

[Data type] Word

4963

M code for specifying a spindle positioning angle

[Unit of data] deg**[Valid data range]** 1 to 60

This parameter sets a basic angular displacement used for half-fixed angle positioning using M codes.

4964

Number of M codes for specifying a spindle positioning angle

[Data type] Byte**[Unit of data]** Integer**[Valid data range]** 0, 1 to 255

This parameter sets the number of M codes used for Half-fixed angle positioning using M codes.

As many M codes as the number specified in this parameter, starting with the M code specified in parameter No. 4962, are used to specify half-fixed angle positioning.

Let α be the value of parameter No. 4962, and let β be the value of parameter No. 4964. That is, M codes from $M\alpha$ to $M(\alpha+5)$ are used for half-fixed angle positioning.

Notes

- 1 This parameter is valid when bit 6 (ESI) of parameter NO. 4950=1.
- 2 Make sure that M codes from $M\alpha$ to $M(\alpha+\beta-1)$ do not duplicate other M codes.
- 3 Setting this parameter to 0 has the same effect as setting 6. That is, M code from $M\alpha$ to $M(\alpha+5)$ are used for half-fixed angle positioning.

4970

Servo loop gain of the spindle

[Data type] Word type**[Unit of data]** 0.01 s⁻¹**[Valid data range]** 1 to 9999

Set the servo loop gain of the spindle in the spindle positioning mode.

4971	Servo loop gain multiplier of the spindle for gear 1
4972	Servo loop gain multiplier of the spindle for gear 2
4973	Servo loop gain multiplier of the spindle for gear 3
4974	Servo loop gain multiplier of the spindle for gear 4

[Data type] Word type

[Unit of data]

[Valid data range]

Set the servo loop gain multipliers of the spindle for gears 1 to 4.

The multipliers are used to convert the amount of the position deviation to the voltage used in the velocity command. Assign the data obtained from the following equation to the parameters.

$$\text{Loop gain multiplier} = 2048000 \times E \times A/L$$

where;

E : Voltage required to rotate the spindle motor at 1000 rpm in the velocity command

L : Rotation angle of the spindle per one motor rotation (normally 360)

A : Unit used for the detection (degree)

Example

Let E be 2.2 V, L be 360 degrees, and A be 0.088 degrees/pulse.

$$\text{Loop gain multiplier} = 2048000 \times 2.2 \times 0.088/360 = 1101$$

Notes

- 1 When the voltage specified for the spindle motor is 10 V at a spindle speed of 4500 rpm, E is regarded as 2.2 V.
- 2 The above parameters No. 4970 to No. 4974 are for analog spindles.

4.15 PARAMETERS OF TOOL COMPENSATION

5000	#7	#6	#5	#4	#3	#2	#1	#0
								SBK

[Data type] Bit type

SBK In HPCC mode, an internally created block for cutter compensation:
 0 : Does not cause a single block stop.
 1 : Causes a single block stop.

5001	#7	#6	#5	#4	#3	#2	#1	#0
		EVO	TPH		TAL	OFH	TLB	TLC

[Data type] Bit type

TLC Tool length compensation
 0 : Tool length compensation A or B (Conforms to TLB in parameter No. 5001)
 1 : Tool length compensation C

TLB Tool length compensation axis
 0 : Always Z axis irrespective of plane specification (Tool length compensation A)
 1 : Axis perpendicular to plane specification (G17, G18, and G19) (Tool length compensation B)

OFH Offset number of tool length compensation, cutter compensation and tool offset
 0 : Specifies the tool length compensation using an H code, and cutter compensation C using a D code
 Tool offset conforms to TPH in parameter No. 5001#5.
 1 : Specifies the tool length compensation, cutter compensation and tool offset using H codes

Note
 Be sure to set this parameter to 1 for cutter compensation B.

TAL Tool length compensation C
 0 : Generates an alarm when two or more axes are offset
 1 : Not generate an alarm even if two or more axes are offset

TPH Specifies whether address D or H is used as the address of tool offset number (G45 to G48).
 0 : D code
 1 : H code

Note

TPH is valid when OFH in parameter No. 5001#2 is 0.

EVO Specifies whether an offset is effective in the next block to be buffered or the next block for which an H code is specified when the offset value is changed in tool length offset A or B.

0 : Next block in which an H code is specified.

1 : Next block to be buffered.

	#7	#6	#5	#4	#3	#2	#1	#0
5002	WNP	LWM	LGC	LGT			LGN	LD1

[Data type] Bit

LD1 Offset number of tool offset (Wear offset number when option of tool geometry/wear compensation is selected)

0 : Specified using the lower two digits of a T code

1 : Specified using the lower one digit of a T code

LGN Geometry offset number of tool offset (When the option of tool geometry/wear compensation is selected, it is effective.)

0 : Is the same as wear offset number

1 : Specifies the geometry offset number by the tool selection number

LGT Tool geometry compensation (When the option of tool geometry/wear compensation is selected, this parameter is effective. Whenever the option is not selected, compensation is made according to the tool movement.

0 : Compensated by the shift of the coordinate system (Compensation is made in the block of T code regardless of LWM at this time.)

1 : Compensated by the tool movement

LGC Tool geometry compensation (It is effective when the option of tool geometry / wear compensation is selected and LGT = 0. When LGT is 1, it is always canceled.)

0 : Not canceled by offset number 0

1 : Canceled by offset number 0

LWM Tool offset (Wear compensation when option of tool geometry/wear offset is selected, or geometry and wear compensation when LGT = 1.)

0 : is done in the T code block

1 : is done together with the axis movement

Note

When the option of tool geometry/wear compensation is equipped and LGT = 0, the offset is done in a T code block regardless of this parameter.

WNP Imaginary tool tip direction used for tool nose radius compensation, when the geometry/wear compensation option is equipped, is the direction specified by:

0 : Geometry offset number

1 : Wear offset number

	#7	#6	#5	#4	#3	#2	#1	#0
5003	TGC	LVC				CCN		
		LVK		BCK	ICK	CCN	SUV	SUP

[Data type] Bit

SUP Start up or cancel in cutter compensation C

0 : Type A

1 : Type B

SUV When G40, G41, and G42 are specified independently,

0 : The start up and cancel operation conforms to the standard specification.

1 : Moves by a distance corresponding to the offset vector which is vertical to the next block movement.

CCN When automatic reference position return (G28) is specified in the cutter compensation C mode (M series) or in tool nose radius compensation (T series):

0 : The cutter compensation vector is cancelled in movement to an intermediate position.

1 : The cutter compensation vector is not cancelled in movement to an intermediate position, but is cancelled in movement to the reference position.

ICK In HPCC mode, a cutter compensation interference check is:

0 : Done

1 : Not done

BCK In HPCC mode, when a cutter compensation interference check determines that the programmed move direction differs from the offset move direction by between 90 and 270 degrees:

0 : An alarm is issued.

1 : No alarm is issued.

LVC Offset value of tool offset

0 : Not cleared, but held by reset

1 : Cleared by reset

LVK Tool length offset value

0 : Cleared by reset

1 : Not cleared, but held by reset

TGC Tool geometry compensation value

0 : Not canceled by reset

1 : Canceled by reset (Valid when LVC, #6 of parameter No. 5003, is "1")

	#7	#6	#5	#4	#3	#2	#1	#0
5004							ORC	
						ODI		

Note

When this parameter is set, the power must be turned off before operation is continued.

[Data type] Bit type

ORC Tool offset value

0 : Set by the diameter specification (Can be set in only the axis under diameter programming)

1 : Set by the radius specification

ODI A cutter compensation amount is set using:

0 : A radius.

1 : A diameter.

	#7	#6	#5	#4	#3	#2	#1	#0
5005			QNI			PRC		CNI

CNI On the offset screen, Y-axis offset screen, and macro screen, the **[INP.C]** soft key is:

0: Used.

1: Not used. (The **[INP.C]** soft key is not displayed.)

PRC Direct input of tool offset value and workpiece coordinate-system shift value

0 : Not use a PRC signal

1 : Uses a PRC signal

QNI In the function of input of offset value measured B

0 : Not automatically select the tool offset number

1 : Automatically selects a tool offset number

	#7	#6	#5	#4	#3	#2	#1	#0
5006							TGC	OIM
								OIM

[Data type] Bit

OIM When the unit is switched between the inch and metric systems, automatic tool offset value conversion is:

0 : Not performed

1 : Performed

TGC When a T code is specified in a block containing G50, G04, or G10:

0 : No alarm occurs.

1 : P/S alarm No. 245 occurs.

	#7	#6	#5	#4	#3	#2	#1	#0
5008							CNC	CNI

[Data type] Bit type

CNI Interference check for cutter compensation C (M series) or tool-tip radius compensation (T series) is:

0 : Performed

1 : Not performed

CNC During interference check for cutter compensation C (M series) or tool-tip radius compensation (T series), when the direction of movement after application of the offset differs from the programmed direction by between 90° and 270°:

0 : An alarm is issued.

1 : No alarm is issued.

5010	Limit value that ignores the vector when a tool moves on the outside of a corner during cutter compensation C
	Limit value that ignores the vector when a tool moves on the outside of a corner during tool nose radius compensation

[Data type] Word

[Unit of data]

Increment system	IS-A	IS-B	IS-C	Unit
Metric input	0.01	0.001	0.0001	mm
Inch input	0.001	0.0001	0.00001	inch

[Valid data range] 0 to 16383

This parameter sets the limit value that ignores a slight movement occurring when a tool moves on the outside of the corner during cutter compensation C.

5011	
	Denominator constant for finding a three-dimensional tool compensation vector

[Data type] 2-word type

[Unit of data]

Increment system	IS-A	IS-B	IS-C	Unit
Metric input	0.01	0.001	0.0001	mm
Inch input	0.001	0.0001	0.00001	inch

[Valid data range] -99999999 to 99999999

This parameter sets the value of p in the expressions used for finding a three-dimensional tool compensation vector:

$$V_x = i r/p$$

$$V_y = j r/p$$

$$V_z = k r/p$$

where,

V_x, V_y, V_z : Components of a three-dimensional tool compensation vector along the X-axis, Y-axis, and Z-axis, or their parallel axes

i, j, k : Values specified in addresses I, J, and K in the program

r : Compensation value

p : Value set in this parameter

When 0 is set in this parameter, the following is assumed:

$$p = \sqrt{i^2 + J^2 + K^2}$$

5013	Maximum value of tool wear compensation

[Data type] 2-word

[Unit of data]

Increment system	IS-A	IS-B	IS-C	Unit
Metric input	0.01	0.001	0.0001	mm
Inch input	0.001	0.0001	0.00001	inch

[Valid data range]

Increment system	IS-A	IS-B	IS-C
Metric input	0 to 99999	0 to 999999	0 to 9999999
Inch input	0 to 99999	0 to 999999	0 to 9999999

This parameter sets the maximum value of tool wear compensation. The following alarm or warning will be informed when the tool wear compensation (absolute value) exceeding this setting value is set.

Input from MDI	Too many digits
Input by G10	P/S 32 offset value is out of range by G10

5014	Maximum value of incremental input for tool wear compensation

[Data type] 2-word

[Unit of data]

Increment system	IS-A	IS-B	IS-C	Unit
Metric input	0.01	0.001	0.0001	mm
Inch input	0.001	0.0001	0.00001	inch

[Valid data range]

Increment system	IS-A	IS-B	IS-C
Metric input	0 to 99999	0 to 999999	0 to 9999999
Inch input	0 to 99999	0 to 999999	0 to 9999999

This parameter sets the maximum value of tool wear compensation at an incremental input. If the incremental value exceeds the set value, the following alarm or warning message is indicated:

Input from MDI	Data is out of range
Input by G10	P/S 32 offset value is out of range by G10

5015	Distance (XP) between reference position and X axis + contact surface
5016	Distance (XM) between reference position and X axis - contact surface
5017	Distance (ZP) between reference position and Z axis + contact surface
5018	Distance (ZM) between reference position and Z axis - contact surface

[Data type] 2-word

[Unit of data]

Increment system	IS-A	IS-B	IS-C	Unit
Metric input	0.01	0.001	0.0001	mm
Inch input	0.001	0.0001	0.00001	inch

[Valid data range] -99999999 - 99999999

These parameters are related to the function of input of tool offset value measured B.

They set the distance (with sign) between the measurement reference position and sensor contact surface. For an axis under diameter programming, set it by a diameter value.

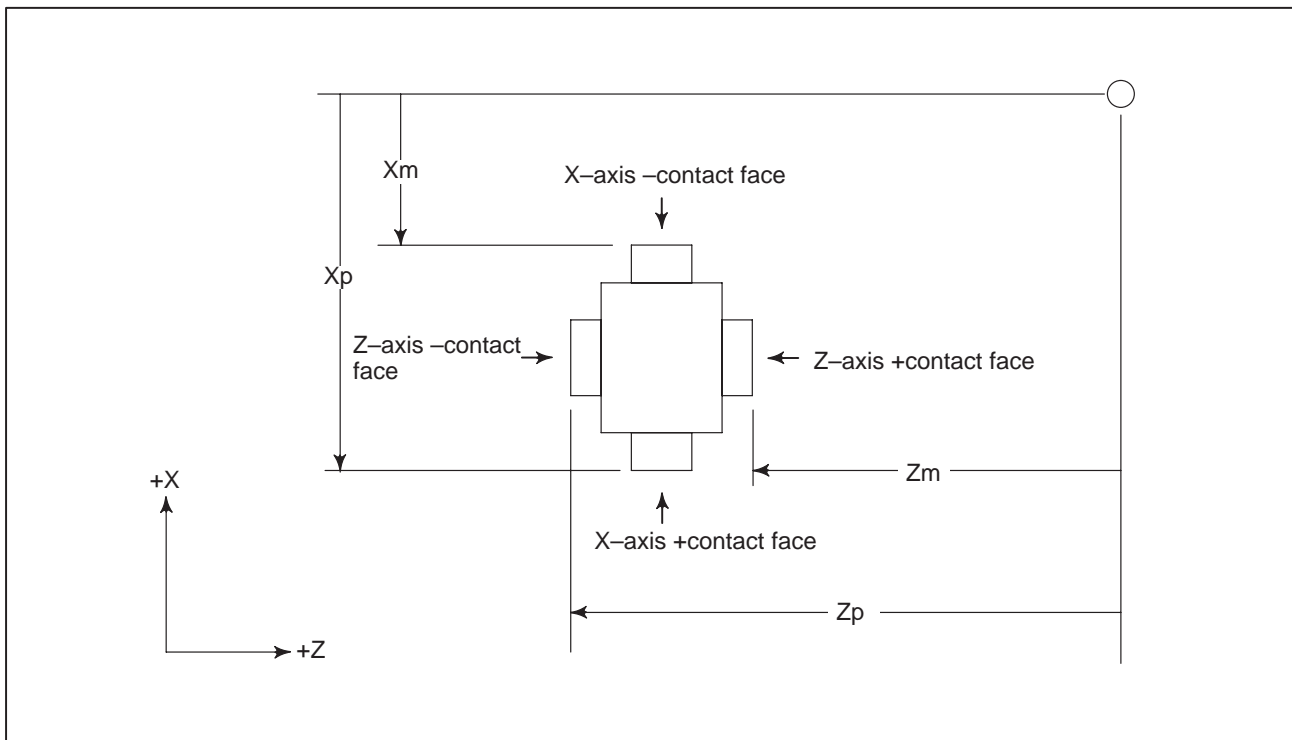

Fig.4.15 Distance along X and Z Axes from the Reference Position to +/- Contact Surfaces

5020	Tool offset number used for the input of tool offset value measured B
------	-----------------------------------------------------------------------

[Data type] Byte

[Valid data range] 0 to the number of tools to be compensated.

Set tool offset number used for the input of tool offset value measured B function (i.e. when workpiece coordinate system shift value is set). (The tool offset number corresponding to the measured tool shall be set in advance.) This parameter is valid when the tool offset number is not selected automatically (QNI, #5 of parameter 5005, is zero).

5030	Minimum grinding wheel diameter in minimum grinding wheel diameter check
------	--------------------------------------------------------------------------

[Data type] 2-word type

[Unit of data]

Increment system	IS-A	IS-B	IS-C	Unit
Metric input	0.01	0.001	0.0001	mm
Input in inches	0.001	0.0001	0.00001	inch

[Valid data range]

Increment system	IS-A, IS-B	IS-C
Metric input	-999999 to 999999	-9999999 to 9999999
Input in inches	-999999 to 999999	-9999999 to 9999999

If the compensation value corresponding to an offset number specified by an H code is smaller than the minimum grinding wheel diameter specified in this parameter during compensation with G43 or G44, the signal F0065#3 GWLF is output to the PMC.

Note

This is a parameter for cylindrical grinding machines.

4.16 PARAMETERS RELATED TO GRINDING–WHEEL WEAR COMPENSATION

5071	Number of first axis for grinding–wheel wear compensation
5072	Number of second axis for grinding–wheel wear compensation

[Data type] Byte type

[Valid data range] 1 to the number of controlled axes

These parameters specify the controlled axis numbers of the first and second axes for which grinding–wheel wear compensation is applied.

5081	Coordinate of first compensation center along first axis on compensation plane
5082	Coordinate of first compensation center along second axis on compensation plane
5083	Coordinate of second compensation center along first axis on compensation plane
5084	Coordinate of second compensation center along second axis on compensation plane
5085	Coordinate of third compensation center along first axis on compensation plane
5086	Coordinate of third compensation center along second axis on compensation plane

[Data type] 2–word type

[Unit of data]

Increment system	IS–A	IS–B	IS–C	Unit
Metric input	0.01	0.001	0.0001	mm
Inch input	0.001	0.0001	0.00001	inch

[Valid data range] –99999999 to 99999999

These parameters specify the coordinates (in the workpiece coordinate system) of the compensation center for grinding–wheel wear compensation.

4.17 PARAMETERS OF CANNED CYCLES

(1) Parameter for canned cycle for drilling

5101	#7	#6	#5	#4	#3	#2	#1	#0
	M5B	M5T	RD2	RD1	ILV	RTR	EXC	FXY

[Data type] Bit

FXY The drilling axis in the drilling canned cycle is:

0 : Always the Z-axis

1 : The axis selected by the program

Note

In the case of the T system, this parameter is valid only for the drilling canned cycle in the Series 15 format.

EXC G81

0 : Specifies a drilling canned cycle

1 : Specifies an external operation command

RTR G83 and G87

0 : Specify a high-speed peck drilling cycle

1 : Specify a peck drilling cycle

ILV Initial point position in drilling canned cycle

0 : Not updated by reset

1 : Updated by reset

RD2, RD1 Set the axis and direction in which the tool in drilling canned cycle G76 or G87 is got free. RD2 and RD1 are set as shown below by plane selection.

RD2	RD1	G17	G18	G19
0	0	+X	+Z	+Y
0	1	-X	-Z	-Y
1	0	+Y	+X	+Z
1	1	-Y	-X	-Z

M5T When a spindle rotates from the forward to the reverse direction and vice versa in tapping cycles G84 and G74 for M series (G84 and G88 for T series), before M04 or M03 is output:

For T series

0 : Not output M05

1 : Outputs M05

For M series

0 : Outputs M05

1 : Not output M05

M5B In drilling canned cycles G76 and G87:

0 : Outputs M05 before an oriented spindle stops

1 : Not output M05 before an oriented spindle stops

	#7	#6	#5	#4	#3	#2	#1	#0
5102	RDI	RAB			F16	QSR	MRC	

[Data type] Bit

MRC When a target figure other than a monotonically increasing or monotonically decreasing figure is specified in a multiple repetitive turning canned cycle (G71, G72):

0 : No alarm occurs.

1 : P/S alarm No. 064 is occurs.

Note

This parameter is valid for multiple repetitive turning canned cycle type I.

QSR Before a multiple repetitive canned cycle (G70 to G73) is started, a check to see if the program contains a block that has the sequence number specified in address Q is:

0 : Not made.

1 : Made. (If the sequence number specified in address Q cannot be found, an alarm occurs and the canned cycle is not executed.)

F16 When the Series 15 format is used (with bit 1 (FCV) of parameter No. 0001 set to 1), a canned drilling cycle is specified using :

0 : Series 15 format

1 : Series 16 format. (However, the number of repetitions is specified using address L.)

RAB The R command for the drilling canned cycle in the Series 15 format is:

0 : Regarded as an incremental command

1 : Regarded as:

An absolute command in the case of G code system A

An absolute command in the case of G code system B or C when the G90 mode is specified.

An incremental command in the case of G code system B or C when the G91 mode is specified.

RDI The R command for the drilling canned cycle in the Series 15 format:

0 : Is regarded as the specification of a radius

1 : Follows the specification of a diameter/radius for the drilling axis

	#7	#6	#5	#4	#3	#2	#1	#0
5103								SIJ

[Data type] Bit

SIJ A tool shift value for the drilling canned cycle G76 or G87 is specified by:

0 : Address Q

1 : Address I, J, or K

5110	C-axis clamp M code in drilling canned cycle

[Data type] Byte

[Valid data range] 0 to 99

This parameter sets the C-axis clamp M code in a drilling canned cycle.

5111	Dwell time when C-axis unclamping is specified in drilling canned cycle

[Data type] Word

[Unit of data] ms

[Valid data range] 0 to 32767

This parameter sets the dwell time when C-axis unclamping is specified in a drilling canned cycle.

5112	Spindle forward-rotation M code in drilling canned cycle

[Data type] Byte

[Valid data range] 0 to 255

This parameter sets the spindle forward-rotation M code in a drilling canned cycle.

Note

M03 is output when "0" is set.

5113	Spindle reverse-rotation M code in drilling canned cycle

[Data type] Byte

[Valid data range] 0 to 255

This parameter sets the spindle reverse-rotation M code in a drilling canned cycle.

Note

M04 is output when "0" is set.

5114	Return or clearance value of drilling canned cycle G83
	Return value of high-speed peck drilling cycle G73

[Data type] Word

[Unit of data]

Increment system	IS-A	IS-B	IS-C	Unit
Metric input	0.01	0.001	0.001	mm
Inch input	0.001	0.0001	0.0001	inch

[Valid data range] 0 to 32767

For 16-MC, this parameter sets the return value in high-speed peck drilling cycle G73 (G83 for 16-TC).

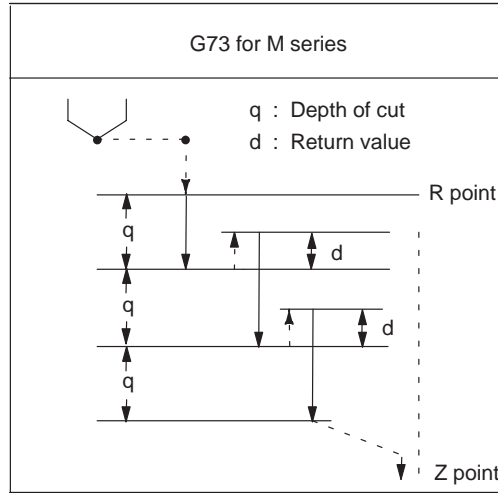

Fig.4.17 (a) High-speed Peck Drilling Cycle G73

For 16-TC, this parameter sets the return or clearance value in drilling canned cycle G83.

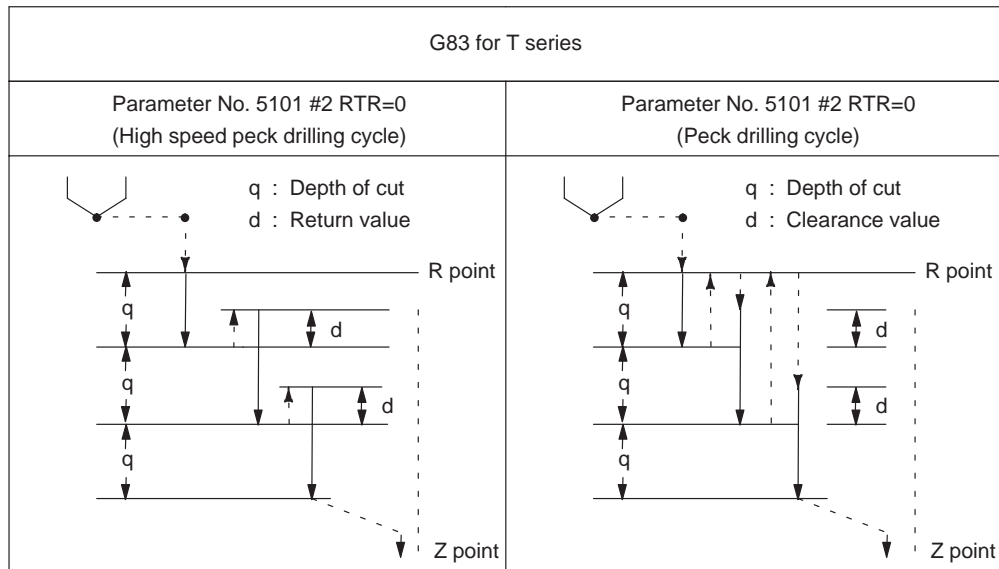

Fig.4.17 (b) Drilling Canned Cycle G83

5115	Clearance of canned cycle G83
------	-------------------------------

[Data type] Word type

[Unit of data]

Increment system	IS-A	IS-B	IS-C	Unit
Input in mm	0.01	0.001	0.001	mm
Input in inches	0.001	0.0001	0.0001	inch

[Valid data range] 0 to 32767

This parameter sets the clearance of peck drilling cycle G83.

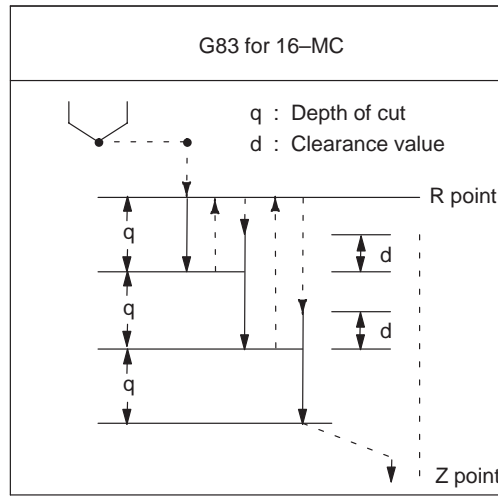

Fig.4.17 (c) Peck drilling cycle G83

(2) Parameter for Thread Cutting Cycle

5130	Chamfering distance in the thread cutting cycles G76 and G92
------	--------------------------------------------------------------

[Data type] Byte

[Unit of data] 0.1 pitch

[Valid data range] 0 to 127

This parameter sets the chamfering in the thread cutting cycles G76 and G92.

(3) Parameter for Multiple Repetitive Canned Cycle

5132	Depth of cut in multiple repetitive canned cycles G71 and G72
------	---------------------------------------------------------------

[Data type] 2-word

[Unit of data]

Increment system	IS-A	IS-B	IS-C	Unit
Metric input	0.01	0.001	0.001	mm
Inch input	0.001	0.0001	0.0001	inch

[Valid data range] 0 to 99999999

This parameter sets the depth of cut in multiple repetitive canned cycles G71 and G72.

5133	Escape in multiple repetitive canned cycles G71 and G72.
------	----------------------------------------------------------

[Data type] 2-word

[Unit of data]

Increment system	IS-A	IS-B	IS-C	Unit
Metric input	0.01	0.001	0.001	mm
Inch input	0.001	0.0001	0.0001	inch

[Valid data range] 0 to 99999999

This parameter sets the escape in multiple repetitive canned cycle G71 and G72.

5135	Escape in multiple repetitive canned cycle G73 in X-axis direction
5136	Escape in multiple repetitive canned cycle G73 in Z-axis direction

[Data type] 2-word type**[Unit of data]**

Increment system	IS-A	IS-B	IS-C	Unit
Input in mm	0.01	0.001	0.001	mm
Input in inches	0.001	0.0001	0.0001	inch

[Valid data range] -99999999 to 99999999

This parameter sets the escape in multiple repetitive canned cycle G73 of an X, then Z axis.

5137	Division count in multiple repetitive canned cycle G73
------	--------------------------------------------------------

[Data type] 2-word**[Unit of data]** Cycle**[Valid data range]** 1 to 99999999

This parameter sets the division count in multiple repetitive canned cycle G73.

5139	Return in multiple canned cycles G74 and G75
------	----------------------------------------------

[Data type] 2-word**[Unit of data]**

Increment system	IS-A	IS-B	IS-C	Unit
Metric input	0.01	0.001	0.001	mm
Inch input	0.001	0.0001	0.0001	inch

[Valid data range] 0 to 99999999

This parameter sets the return in multiple repetitive canned cycles G74 and G75.

5140	Minimum depth of cut in the multiple repetitive canned cycle G76

[Data type] 2–word

[Unit of data]

Increment system	IS–A	IS–B	IS–C	Unit
Metric input	0.01	0.001	0.0001	mm
Inch input	0.001	0.0001	0.00001	inch

[Valid data range] 0 to 99999999

This parameter sets the minimum depth of cut in the multiple repetitive canned cycle G76.

5141	Finishing allowance in the multiple repetitive canned cycle G76

[Data type] 2–word

[Unit of data]

Increment system	IS–A	IS–B	IS–C	Unit
Metric input	0.01	0.001	0.0001	mm
Inch input	0.001	0.0001	0.00001	inch

[Valid data range] 1 to 99999999

This parameter sets the finishing allowance in multiple repetitive canned cycle G76.

5142	Repetition count of final finishing in multiple repetitive canned cycle G76

[Data type] 2–word type

[Unit of data] Cycle

[Valid data range] 1 to 99999999

This parameter sets the repetition count in multiple repetitive canned cycle G76.

5143	Tool nose angle in multiple repetitive canned cycle G76

[Data type] 2–word type

[Unit of data] Degree

[Valid data range] When FS15 format is used: 0 to 120

When FS15 format is not used: 0, 29, 30, 55, 60, 80

This parameter sets the tool nose angle in multiple repetitive canned cycle G76.

(4) Parameters for Peck Drilling Cycle of a Small Diameter

	#7	#6	#5	#4	#3	#2	#1	#0
5160								
						NOL	OLS	

[Data type] Bit

- OLS** When an overload torque signal is received in a peck drilling cycle of a small diameter, the feed and spindle speed are
 0 : Not changed.
 1 : Changed.
- NOL** When the depth of cut per action is satisfied although no overload torque signal is received in a peck drilling cycle of a small diameter, the feed and spindle speed are:
 0 : Not changed.
 1 : Changed.

5163	
	M code that specifies the peck drilling cycle mode of a small diameter

[Data type] 2-word

[Unit of data]

[Valid data range] 1 to 99999999

This parameter sets an M code that specifies the peck drilling cycle mode of a small diameter.

5164	
	Percentage of the spindle speed to be changed when the tool is retracted after an overload torque signal is received

[Data type] Byte

[Unit of data] %

[Valid data range] 1 to 255

This parameter sets the percentage of the spindle speed to be changed when the tool is retracted because the overload torque signal is received in a peck drilling cycle of a small diameter.

$$S2 = S1 \times d1 \div 100$$

S1: Spindle speed to be chaged

S2: Spindle speed changed

d1 is set as a percentage.

5165	
	Percentage of the spindle speed to be changed when the tool is retracted without an overload torque signal received

[Data type] Byte

[Unit of data] %

[Valid data range] 1 to 255

This parameter sets the percentage of the spindle speed to be changed when the tool is retracted without the overload torque signal received in a peck drilling cycle of a small diameter.

$$S2 = S1 \times d2 \div 100$$

S1: Spindle speed to be chaged

S2: Spindle speed changed

d2 is set as a percentage.

5166	
	Percentage of cutting feedrate to be changed when the tool is retracted after an overload torque signal is received

[Data type] Byte

[Unit of data] %

[Valid data range] 1 to 255

This parameter sets the percentage of the cutting feedrate to be changed when the tool is retracted because the overload torque signal is received in a peck drilling cycle of a small diameter.

$$F2 = F1 \times b1 \div 100$$

F1: Cutting feedrate to be changed

F2: Changed cutting feedrate

b1 is set as a percentage.

5167	
	Percentage of the cutting feedrate to be changed when the tool is retracted without an overload torque signal received

[Data type] Byte

[Unit of data] %

[Valid data range] 1 to 255

This parameter sets the percentage of the cutting feedrate tot be changed when the tool is retracted without the overload torque signal received in a peck drilling cycle of a small diameter.

$$F2 = F1 \times b2 \div 100$$

F1: Cutting feedrate to be changed

F2: Changed cutting feedrate

b2 is set as a percentage.

5168	
	Lower limit of the percentage of the cutting feedrate in a peck drilling cycle of a small diameter

[Data type] Byte

[Unit of data] %

[Valid data range] 0 to 255

This parameter sets the lower limit of the percentage of the cutting feedrate changed repeatedly in a peck drilling cycle of a small diameter to the specified cutting feedrate.

$$FL = F \times b3 \div 100$$

F: Specified cutting feedrate

FL: Changed cutting feedrate

Set b3 as a percentage.

5170	
	Number of the macro variable to which the total number of retractions during cutting is output

[Data type] Word

[Valid data range] 100 to 149

This parameter sets the number of the macro variable to which the total number of times the tool is retracted during cutting in a peck drilling cycle mode of a small diameter is output.

Note

The total number cannot be output to common variables 500 to 599.

5171	
	Number of the macro variable to which the total number of retractions because of an overload signal is output

[Data type] Word

[Valid data range] 100 to 149

This parameter sets the common variable number of the custom macro to which the number of times the tool is retracted after the overload signal is received during cutting in a peck drilling cycle mode of a small diameter is output.

Note

The total number cannot be output to common variables 500 to 599.

5172	
	Speed of retraction to point R when no address I is issued

[Data type] Word

[Unit of data] mm/min

[Valid data range] 0 to 400

This parameter sets the speed of retraction to point R when no address I is issued in a peck drilling cycle of a small diameter.

5173	
	Speed of advancing to the position just before the bottom of a hole when no address I is issued

[Data type] Word

[Unit of data] mm/min

[Valid data range] 0 to 400

This parameter sets the speed of advancing to the position just before the bottom of a previously machined hole when no address I is issued in a peck drilling cycle of a small diameter.

5174	
	Clearance in a peck drilling cycle of a small diameter

[Data type] Word

[Unit of data]

Increment system	IS-A	IS-B	IS-C	Unit
Linear axis (millimeter input)	0.01	0.001	0.0001	mm
Linear axis (inch input)	0.001	0.0001	0.00001	inch

[Valid data range] 0 to 32767

This parameter sets the clearance in a peck drilling cycle of a small diameter.

4.18 PARAMETERS OF RIGID TAPPING

	#7	#6	#5	#4	#3	#2	#1	#0
5200	SRS	FHD		DOV	SIG	CRG	VGR	G84
		FHD	PCP	DOV	SIG	CRG	VGR	G84

[Data type] Bit

G84 Method for specifying rigid tapping

0 : An M code specifying the rigid tapping mode is specified prior to the issue of the G84 (or G74) command. (See parameter No. 5210).

1 : An M code specifying the rigid tapping mode is not used. (G84 cannot be used as a G code for the tapping cycle; G74 cannot be used for the reverse tapping cycle.)

VGR Any gear ratio between spindle and position coder in rigid tapping

0 : Not used (The gear ratio is set in parameter No. 3706.)

1 : Used (The gear ratio is set by parameters Nos. 5221 through 5224 and 5231 through 5234.)

Note

For serial spindles, set this parameter to 0 when using the DMR function for position coder signals on the spindle side.

CRG Rigid mode when a rigid mode cancel command is specified (G80, G01 group G code, reset, etc.)

0 : Canceled after rigid tapping signal RGTAP is set to "0".

1 : Canceled before rigid tapping signal RGTAP is set to "0".

SIG When gears are changed for rigid tapping, the use of SIND <G032 and G033> is

0 : Not permitted.

1 : Permitted.

DOV Override during extraction in rigid tapping

0 : Invalidated

1 : Validated (The override value is set in parameter No. 5211.)

PCP Rigid tapping

0 : Used as a high-speed peck tapping cycle

1 : Not used as a high-speed peck tapping cycle

FHD Feed hold and single block in rigid tapping

0 : Invalidated

1 : Validated

SRS To select a spindle used for rigid tapping in multi-spindle control:

0 : The spindle selection signals SWS1 and SWS2 (bits 0 and 1 of G027) are used. (These signals are used also for multi-spindle control.)

1 : The rigid tapping spindle selection signals RGTSP1 and RGTSP2 (bits 4 and 5 of G061) are used. (These signals are provided expressly for rigid tapping.)

	#7	#6	#5	#4	#3	#2	#1	#0
5201				OV3	OVU	TDR		
				OV3	OVU	TDR		NIZ

[Data type] Bit

NIZ Smoothing in rigid tapping is:

- 0 : Not performed.
- 1 : Performed.

TDR Cutting time constant in rigid tapping

- 0 : Uses a same parameter during cutting and extraction (Parameter Nos. 5261 through 5264)
- 1 : Not use a same parameter during cutting and extraction
 Parameter Nos. 5261 to 5264: Time constant during cutting
 Parameter Nos. 5271 to 5274: Time constant during extraction

OVU The increment unit of the override parameter (No. 5211) for tool rigid tapping extraction is:

- 0 : 1%
- 1 : 10%

OV3 The spindle speed for tool extraction is specified by program. Overriding based on this spindle speed is:

- 0 : Disabled.
- 1 : Enabled.

	#7	#6	#5	#4	#3	#2	#1	#0
5202								
								ORI

Note

When this parameter is set, the power must be turned off before operation is continued.

[Data type] Bit

ORI When rigid tapping is started:

- 0 : Spindle orientation is not performed.
- 1 : Spindle orientation is performed.

Note

This parameter can be used only for a serial spindle.

	#7	#6	#5	#4	#3	#2	#1	#0
5203								
							HRM	HRG

HRG Rigid tapping by the manual handle is:

- 0 : Disabled.
- 1 : Enabled.

- HRM** When the tapping axis moves in the negative direction during rigid tapping controlled by the manual handle, the direction in which the spindle rotates is determined as follows:
- 0 : In G84 mode, the spindle rotates in a normal direction. In G74 mode, the spindle rotates in reverse.
 - 1 : In G84 mode, the spindle rotates in reverse. In G74 mode, the spindle rotates in a normal direction.

	#7	#6	#5	#4	#3	#2	#1	#0
5204								DGN

Note

When this parameter is set, the power must be turned off before operation is continued.

[Data type] Bit

DGN On the diagnosis screen:

- 0 : A rigid tapping synchronization error is displayed. (Nos. 455 to 457)
- 1 : An error difference between the spindle and tapping axis is displayed. (Nos. 452 and 453)

5210	Rigid tapping mode specification M code
------	-----------------------------------------

[Data type] Byte

[Valid data range] 0 to 255

This parameter sets an M code that specifies the rigid tapping mode. To set an M code larger than 255, set it to parameter No. 5212.

Note

The M code is judged to be 29 (M29) when "0" is set.

5211	Override value during rigid tapping extraction
------	------------------------------------------------

[Data type] Byte

[Unit of data] 1 % or 10 %

[Valid data range] 0 to 200

The parameter sets the override value during rigid tapping extraction.

Note

The override value is valid when DOV in parameter No. 5200 #4 is "1".

When OVU (bit 3 of parameter No. 5201) is 1, the unit of set data is 10%. An override of up to 200% can be applied to extraction.

5212	M code that specifies a rigid tapping mode
------	--------------------------------------------

[Data type] 2-word

[Unit of data] Integer

[Valid data range] 0 to 65535

This parameter sets the M code that specifies the rigid tapping mode. The M code that specifies the rigid tapping mode is usually set by parameter 5210. To use an M code whose number is greater than 255, specify the code number with parameter 5212.

Note

If the setting of this parameter is 0, the M code specifying the rigid tapping mode is determined by the setting of parameter 5210. Otherwise, it is determined by the setting of parameter 5212. The setting of parameter 5212 must always be within the above valid range.

5213	Return or clearance in peck tapping cycle
------	-------------------------------------------

[Data type] Word

[Unit of data]

Increment system	IS-A	IS-B	IS-C	Unit
Input in mm	0.01	0.001	0.0001	mm
Input in include	0.001	0.0001	0.00001	inch

[Valid data range] 0 to 32767

This parameter sets the return or clearance in the peck tapping cycle.

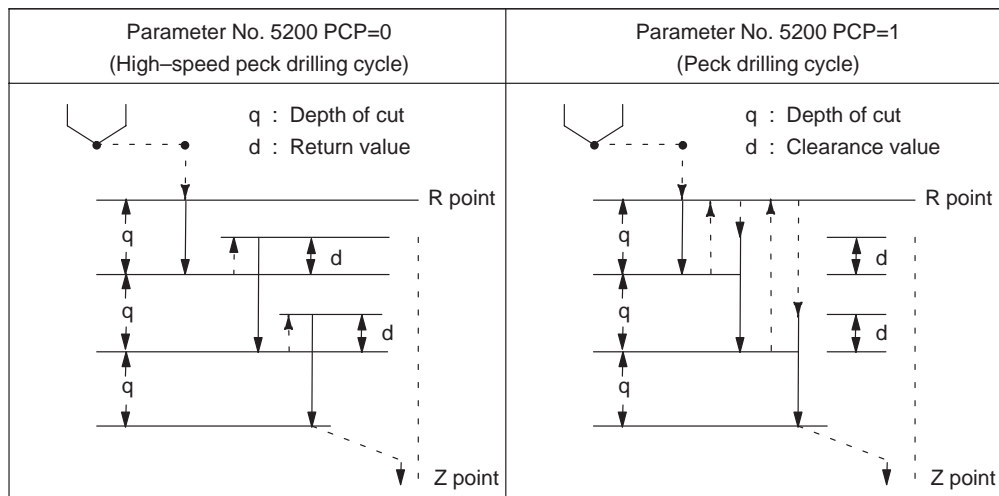

Fig.4.18 (a) High-speed Peck Drilling and Peck Drilling Cycles

[Data type] Word type

5214	Rigid tapping synchronization error range setting
------	---------------------------------------------------

[Unit of data] Detection unit

[Valid data range] 0 to 32767

This parameter sets an allowable synchronization error range for rigid tapping.

When the synchronization error exceeds the allowable range set with this parameter, the servo alarm No. 411 of the tapping axis (excessive error during movement) is issued. Note that when 0 is set with this parameter, no synchronization error check is performed.

5221	Number of gear teeth on the spindle side in rigid tapping (First gear)
------	------------------------------------------------------------------------

5222	Number of gear teeth on the spindle side in rigid tapping (Second gear)
------	-------------------------------------------------------------------------

5223	Number of gear teeth on the spindle side in rigid tapping (Third gear)
------	------------------------------------------------------------------------

5224	Number of gear teeth on the spindle side in rigid tapping (Fourth gear)
------	-------------------------------------------------------------------------

[Data type] Word type

[Valid data range] 1 to 32767

These parameters set the number of gear teeth on the spindle side for every gear when any gear ratio is set in rigid tapping.

Note

This parameter is valid when VGR, #1 of parameter No. 5200, is "1".

Set the same value to parameter Nos. 5221 to 5224 when the spindle has a position coder.

Note

For serial spindles, set this parameter and bit 1 (VGR) of parameter No. 5200 to 0, when using the DMR function for position coder signals on the spindle side.

5231	Number of gear teeth on the position coder side in rigid tapping (First gear)
------	-------------------------------------------------------------------------------

5232	Number of gear teeth on the position coder side in rigid tapping (Second gear)
------	--------------------------------------------------------------------------------

5233	Number of gear teeth on the position coder side in rigid tapping (Third gear)
------	-------------------------------------------------------------------------------

5234	Number of gear teeth on the position coder side in rigid tapping (Fourth gear)
------	--------------------------------------------------------------------------------

[Data type] Word type

[Valid data range] 1 to 32767

These parameters set the number of gear teeth on the position coder side for every gear when any gear ratio is set in rigid tapping.

Note

This parameter is valid when VGR, #1 of parameter No. 5200, is "1".

Set the same value to parameter Nos. 5231 to 5234 when the spindle has position coder.

A spindle motor incorporating the position coder uses a position coder with 2048 pulses per revolution.

In this case, set the value that is two times as many as the actual number of gear teeth (because of conversion to 4096 pulses per revolution).

Note

For serial spindles, set this parameter and bit 1 (VGR) of parameter No. 5200 to 0, when using the DMR function for position coder signals on the spindle side.

5241	Maximum spindle speed in rigid tapping (First gear)
5242	Maximum spindle speed in rigid tapping (Second gear)
5243	Maximum spindle speed in rigid tapping (Third gear)
5244	Maximum spindle speed in rigid tapping (Fourth gear)

[Data type] 2-word type

[Unit of data] rpm

[Valid data range] Spindle and position coder gear ratio

1:1 0 to 7400

1:2 0 to 9999

1:4 0 to 9999

1:8 0 to 9999

These parameters set the maximum spindle speed for every gear in rigid tapping.

Note

In a system having one-stage gear, set the same value as parameter No. 5241 to parameter No. 5243. In a system having two-stage gear, set the same value as parameter No. 5242 to parameter No. 5241. If it is not set as such, P/S alarm no. 200 will be informed. These are applicable for M series.

5261	Acceleration/deceleration time constant for every gear in rigid tapping (First gear)
5262	Acceleration/deceleration time constant for every gear in rigid tapping (Second gear)
5263	Acceleration/deceleration time constant for every gear in rigid tapping (Third gear)
5264	Acceleration/deceleration time constant for every gear in rigid tapping (Fourth gear)

[Data type] Word type

[Unit of data] ms

[Valid data range] 0 to 4000

These parameters set the spindle and tapping axis's time constant for every gear during linear acceleration/deceleration in rigid tapping.

Set the time required until a spindle speed reaches the maximum spindle speed (parameter Nos. 5241 and greater). The actual time constant is a proportional value between the maximum spindle speed and the specified S.

5271	Acceleration/deceleration time constant during extraction in rigid tapping (First gear)
5272	Acceleration/deceleration time constant during extraction in rigid tapping (Second gear)
5273	Acceleration/deceleration time constant during extraction in rigid tapping (Third gear)
5274	Acceleration/deceleration time constant during extraction in rigid tapping (Fourth gear)

[Data type] Word type

[Unit of data] ms

[Valid data range] 0 to 4000

These parameters set the linear acceleration/deceleration time constant of a spindle and tapping axis for every gear during extraction in rigid tapping.

Note

The time constant is valid when TDR, #2 of parameter No. 5201, is "1".

5280	Position control loop gain of spindle and tapping axis in rigid tapping (Common in each gear)
------	--------------------------------------------------------------------------------------------------

Note

When this parameter is set, the power must be turned off before operation is continued.

[Data type] Word type

[Unit of data] 0.01 per second

[Valid data range] 1 to 9999

This parameter sets the position control loop gain of a spindle and tapping axis in rigid tapping.

The loop gain setting significantly influences the screw precision. Perform a cutting test to adjust the loop gain and its multiplier to the optimum values.

Note

To change the loop gain for every gear, set this parameter value to "0" and set the loop gain for every gear to parameter Nos. 5281 through 5284. If this parameter value is not "0", the loop gain for every gear is invalidated. This parameter then becomes a loop gain that is used in common for all gears.

5281	Position control loop gain of spindle and tapping axis in rigid tapping (First gear)
5282	Position control loop gain of spindle and tapping axis in rigid tapping (Second gear)
5283	Position control loop gain of spindle and tapping axis in rigid tapping (Third gear)
5284	Position control loop gain of spindle and tapping axis in rigid tapping (Fourth gear)

Note

When this parameter is set, the power must be turned off before operation is continued.

[Data type] Word type

[Unit of data] 0.01 per second

[Valid data range] 1 to 9999

These parameters set the position control loop gain of a spindle and tapping axis for every gear in rigid tapping.

Note

To set the loop gain for every gear, set parameter No. 5280 to "0".

5291	Spindle loop gain multiplier in the rigid tapping mode (for gear 1)
5292	Spindle loop gain multiplier in the rigid tapping mode (for gear 2)
5293	Spindle loop gain multiplier in the rigid tapping mode (for gear 3)
5294	Spindle loop gain multiplier in the rigid tapping mode (for gear4)

[Data type] Word type

[Unit of data]

[Valid data range] 0 to 32767

Set the spindle loop gain multipliers for gears 1 to 4 in the rigid tapping mode. The thread precision depends on the multipliers. Find the most appropriate multipliers by conducting the cutting test and assign them to the parameters.

Note

These parameters are used for analog spindles.

Loop gain multiplier = 2048 × E/L × α × 1000

where;

- E : Voltage in the velocity command at 1000 rpm
- L : Rotation angle of the spindle per one rotation of the spindle motor
- α : Unit used for the detection

Examples

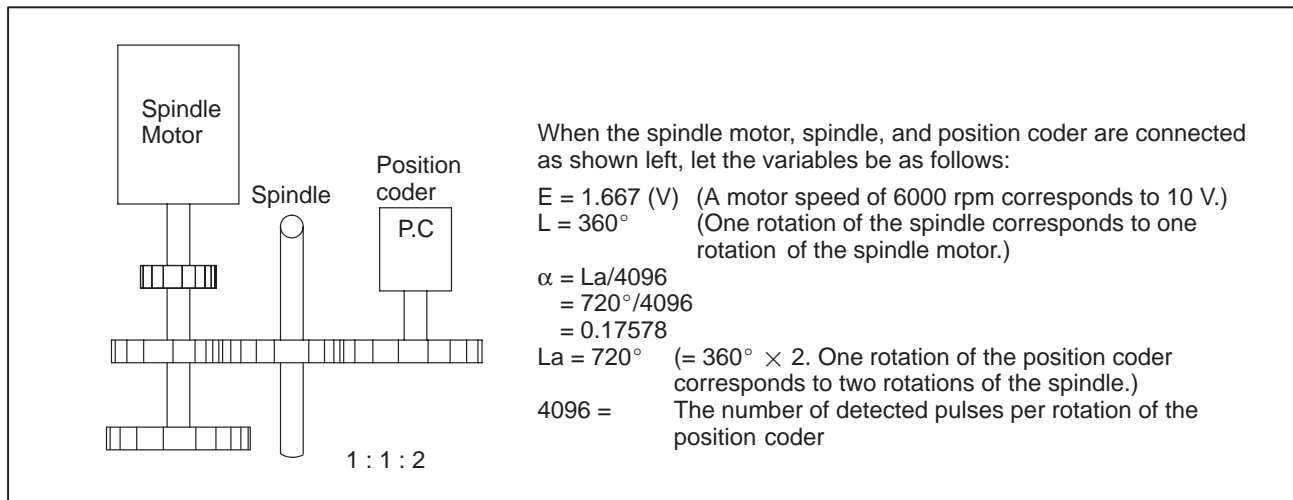

Fig.4.18 (b) Connection among the spindle motor, spindle, and position coder

Gear ratio between the spindle and the position coder

1:1 0.08789 degrees

1:2 0.17578 degrees

1:4 0.35156 degrees

1:8 0.70313 degrees

According to above ratio the loop gain multiplier is calculated as 2048
 $\times 1.667/360 \times 0.17578 \times 1000 = 1667$

Note

When the position coder which is built in a spindle motor sends 512 pulses per rotation, the unit used for the detection, α , is $La/2048$.

5300

In-position width of tapping axis in rigid tapping

[Data type] Word type

[Unit of data] Detection unit

[Valid data range] 1 to 32767

This parameter sets the in-position width of a tapping axis in rigid tapping.

5301

In-position width of spindle in rigid tapping

[Data type] Word

[Unit of data] Detection unit

[Valid data range] 0 to 32767

This parameter sets the in-position width of a spindle in rigid tapping.

Note

The broad in-position width deteriorates the screw precision.

5310

Limit value of tapping axis positioning deviation during movement in rigid tapping

[Data type] Word type

[Unit of data] Detection unit

[Valid data range] 1 to 32767

To set a value larger than this value, set is to No. 5314.

This parameter sets the limit value of a tapping axis positioning deviation during movement in rigid tapping.

Note

The setting value is represented in a 10-times unit when a high-resolution transducer is used.

5311

Limit value of spindle positioning deviation during movement in rigid tapping.

[Data type] Word type**[Unit of data]** Detection unit**[Valid data range]** 1 to 32767

This parameter sets the limit value of a spindle positioning deviation during movement in rigidtapping.

$$\text{Limit value} = S \times 360 \times 100 \times 1.5 / (60 \times G \times \alpha)$$

where

S : Maximum spindle speed in rigid tapping
(Setting value of parameter Nos. 5241 and greater)

G : Loop gain of rigid tapping axis
(Setting value of parameter Nos. 5280 and greater)

α : Detection unit

(Calculation example)

Fig.4.18 (c) Connection Among Spindle Motor, Spindle and Position Coder

Note

The detection unit is $\alpha = La/2048$ when the position coder built-in spindle motor uses a position coder of 512 pulses per revolution.

5312

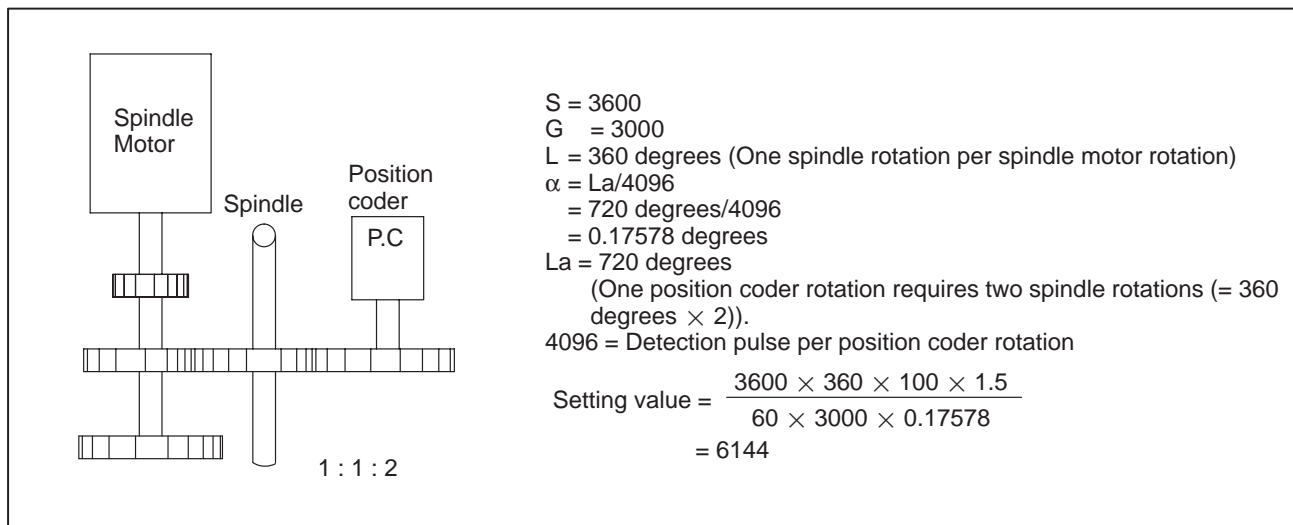
Limit value of tapping axis positioning deviation during stop in rigid tapping

[Data type] Word type**[Unit of data]** Detection unit**[Valid data range]** 1 to 32767

This parameter sets the limit value of a tapping axis positioning deviation during stop in rigid tapping.

5313

Limit value of spindle positioning deviation during stop in rigid tapping

[Data type] Word type**[Unit of data]** Detection unit**[Valid data range]** 1 to 32767

This parameter sets the limit value of a spindle positioning deviation during stop in rigid tapping.

5314

Limit of position deviation during movement along the tapping axis for rigid tapping

[Data type] 2-word type**[Unit of data]** Detection unit**[Valid data range]** 0 to 99999999

Parameter 5310 usually sets the limit of positional deviation during movement along the tapping axis for rigid tapping. To specify a setting exceeding the valid range specified in parameter 5310 according to the resolution of the detector to be used, specify the limit with parameter 5314.

Note

If the setting of this parameter is 0, the setting of parameter 5310 is enabled. Otherwise, the setting of parameter 5310 is disabled, and the setting of parameter 5314 is enabled.

5321

Spindle backlash in rigid tapping (First gear)

Spindle backlash in rigid tapping

5322

Spindle backlash in rigid tapping (Second gear)

5323

Spindle backlash in rigid tapping (Third gear)

5324

Spindle backlash in rigid tapping (Fourth gear)

[Data type] Byte type**[Unit of data]** Detection unit**[Valid data range]** 0 to 127

These parameters set the spindle backlash in rigid tapping.

5382

Overshoot in rigid tapping return

[Data type] 2-word**[Unit of data]** Input increment

[Valid data range] 0 to 99999999

For rigid tapping return (in the machining return or restart function), the tap axis can be extracted from the rigid tapping start position further to the position determined by adding a value specified in this parameter.

4.19 PARAMETERS OF SCALING/COORDINA TE ROTATION

	#7	#6	#5	#4	#3	#2	#1	#0
5400								RIN
	SCR	XSC						RIN

[Data type] Bit type

RIN Coordinate rotation angle command (R)

0 : Specified by an absolute method

1 : Specified by G90 or G91

XSC Axis scaling and programmable mirror image

0 : Invalidated (The scaling magnification is specified by P.)

1 : Validated

SCR Scaling magnification unit

0 : 0.00001 times (1/100,000)

1 : 0.001 times

	#7	#6	#5	#4	#3	#2	#1	#0
5401								
								SCLx

[Data type] Bit axis

SCLx Scaling for every axis

0 : Invalidated

1 : Validated

5410	Angular displacement used when no angular displacement is specified for coordinate system rotation
------	----------------------------------------------------------------------------------------------------

[Data type] 2-word

[Unit of data] 0.001 degrees

[Valid data range] -360000 to 360000

This parameter sets the angular displacement for coordinate system rotation. When the angular displacement for coordinate system rotation is not specified with address R in the block where G68 is specified, the setting of this parameter is used as the angular displacement for coordinate system rotation.

5411	
	Magnification used when scaling magnification is not specified

Setting entry is acceptable.

[Data type] 2-word

[Unit of data] 0.001 or 0.00001 times (Selected using SCR, #7 of parameter No. 5400)

[Valid data range] 1 to 999999

This parameter sets the scaling magnification. This setting value is used when a scaling magnification (P) is not specified in the program.

Note

Parameter No. 5421 becomes valid when scaling for every axis is valid. (XSC, #6 of parameter No. 5400 is "1".)

5421	Scaling magnification for every axis
------	--------------------------------------

Setting entry is acceptable.

[Data type] 2-word

[Unit of data] 0.001 or 0.00001 times (Selected using SCR, #7 of parameter No. 5400)

[Valid data range] -999999 to -1, 1 to 999999

This parameter sets the scaling magnification for every axis.

4.20 PARAMETERS OF UNI-DIRECTIONAL POSITIONING

	#7	#6	#5	#4	#3	#2	#1	#0
5431								
								MDL

[Data type] Bit

MDL Specifies whether the G code for single direction positioning (G60) is included in one-shot G codes (00 group) or modal G codes (01 group)
 0: One-shot G codes (00 group)
 1: Modal G codes (01 group)

5440	
	Positioning direction and overrun distance in uni-directional positioning for each axis

[Data type] Word axis

[Unit of data]

Increment system	IS-A	IS-B	IS-C	Unit
Metric input	0.01	0.001	0.0001	mm
Inch input	0.001	0.0001	0.00001	inch
Rotation axis	0.01	0.001	0.0001	deg

[Valid data range] -16383 to +16383

This parameter sets the positioning direction and overrun distance in uni-directional positioning (G60) for each axis. The positioning direction is specified using a setting data sign, and the overrun distance using a value set here.

Overrun distance > 0: The positioning direction is positive (+).

Overrun distance < 0: The positioning direction is negative (-).

Overrun distance = 0: Uni-directional positioning is not performed.

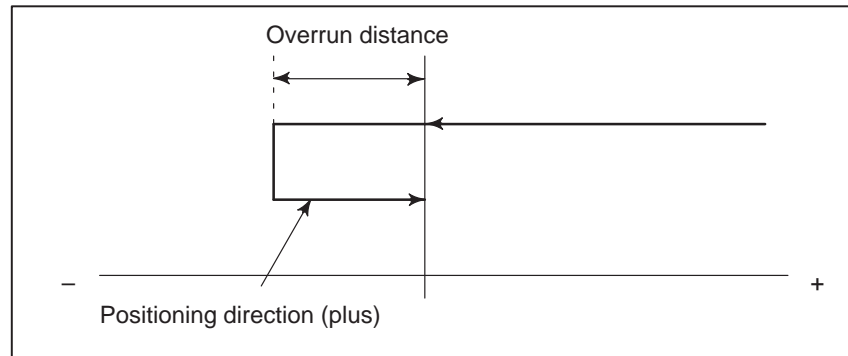

Fig.4.20 Positioning Direction and Overrun distance

4.21 PARAMETERS OF POLAR COORDINATE INTERPOLATION

	#7	#6	#5	#4	#3	#2	#1	#0
5450							AFC	

[Data type] Bit type

AFC In polar coordinate interpolation mode, automatic override operation and automatic feedrate clamp operation are:

0 : Not performed.

1 : Performed.

Note

In polar coordinate interpolation mode, the feedrate component for a rotational axis increases as the tool moves closer to the center of a workpiece. Near the center of a workpiece, the maximum cutting feedrate (parameter No. 5462) may be exceeded, causing servo alarm No. 411 to be issued. The automatic feedrate override function and automatic feedrate clamp function automatically control the feedrate to prevent the feedrate component on a rotation axis from exceeding a specified maximum cutting feedrate.

5460	Axis (linear axis) specification for polar coordinate interpolation
------	---------------------------------------------------------------------

5461	Axis (rotary axis) specification for polar coordinate interpolation
------	---------------------------------------------------------------------

[Data type] Byte

[Valid data range] 1, 2, 3, ... control axes count

These parameters set control axis numbers of linear and rotary axes to execute polar interpolation.

5462	Maximum cutting feedrate during polar coordinate interpolation
------	----------------------------------------------------------------

[Data type] 2-word

[Unit of data]

[Valid data range]

Increment system	Unit of data	Valid data range	
		IS-A, IS-B	IS-C
Millimeter machine	1 mm/min	0, 6 – 240000	0, 6 – 100000
Inch machine	0.1 inch/min	0, 6 – 96000	0, 6 – 48000
Rotation axis	1 deg/min	0, 6 – 240000	0, 6 – 100000

This parameter sets the upper limit of the cutting feedrate that is effective during polar coordinate interpolation. If a feedrate greater than the maximum feedrate is specified during polar coordinate interpolation, it is clamped to the feedrate specified by the parameter. When the setting is 0, the feedrate during polar coordinate interpolation is clamped to the maximum cutting feedrate usually specified with parameter 1422.

5463

Allowable automatic override percentage in polar coordinate interpolation

[Data type] Byte type**[Unit of data]** %**[Valid data range]** 0 to 100

This parameter sets an allowable percentage to find an allowable feedrate on a rotation axis in polar coordinate interpolation mode. A maximum cutting feedrate (parameter No. 5462), multiplied by the allowable percentage set with this parameter represents an allowable feedrate.

$$(\text{Allowable feedrate on rotation axis}) = (\text{maximum cutting feedrate}) \times (\text{allowable percentage})$$

In polar coordinate interpolation mode, the feedrate component on a rotation axis increases as the tool moves closer to the center of a workpiece. Near the center of a workpiece, the maximum allowable feedrate (parameter No. 5462) may be exceeded. To prevent the feedrate component on a rotation axis from exceeding the maximum allowable feedrate in polar coordinate interpolation mode, the following override is automatically applied to the feedrate (automatic override):

$$(\text{Override}) = \frac{(\text{Allowable feedrate on rotation axis})}{(\text{Feedrate component on rotation axis})} \times 100 (\%)$$

If the overridden feedrate component for a rotation axis still exceeds the allowable feedrate, the feedrate is clamped to prevent the feedrate component on a rotation axis from exceeding a maximum cutting feedrate (automatic feedrate clamp).

Note

When 0 is set in this parameter, a specification of 90% is assumed. When a value of 100 or greater is set with this parameter, a specification of 100% is assumed. Before the automatic override function and automatic feedrate clamp function can be used, bit 1 (AFC) of parameter No. 5450 must be set to 1.

4.22 PARAMETERS OF NORMAL DIRECTION CONTROL

5480	
	Number of the axis for controlling the normal direction

[Data type] Byte

[Valid data range] 1 to the maximum control axis number

This parameter sets the control axis number of the axis for controlling the normal direction.

5481	
	Rotation feedrate of normal direction control axis

[Data type] Word

[Unit of data] 1 deg/min

[Valid data range] 1 to 15000

This parameter sets the feedrate of a normal direction control axis that is inserted at the start point of a block during normal direction control.

5482	Limit value that ignores the rotation insertion of normal direction control axis
------	----------------------------------------------------------------------------------

[Data type] 2–word

[Unit of data]

Increment system	IS–A	IS–B	IS–C	Unit
Rotation axis	0.01	0.001	0.0001	deg

[Valid data range] 1 to 99999999

The rotation block of a normal direction control axis is not inserted when the rotation insertion angle calculated during normal direction control does not exceed this setting value. The ignored rotation angle is added to the next rotation insertion angle. The block insertion is then judged.

Notes

- 1 No rotation block is inserted when 360 or more degrees are set.
- 2 If 180 or more degrees are set, a rotation block is inserted only when the circular interpolation is 180 or more degrees.

5483	Limit value of movement that is executed at the normal direction angle of a preceding block
------	---------------------------------------------------------------------------------------------

[Data type] 2–word

[Unit of data]

Increment system	IS-A	IS-B	IS-C	Unit
Metric input	0.01	0.001	0.0001	mm
Inch input	0.001	0.0001	0.00001	inch

[Valid data range] 1 to 99999999

This parameter sets the limit value of movement at the normal direction angle of a preceding block.

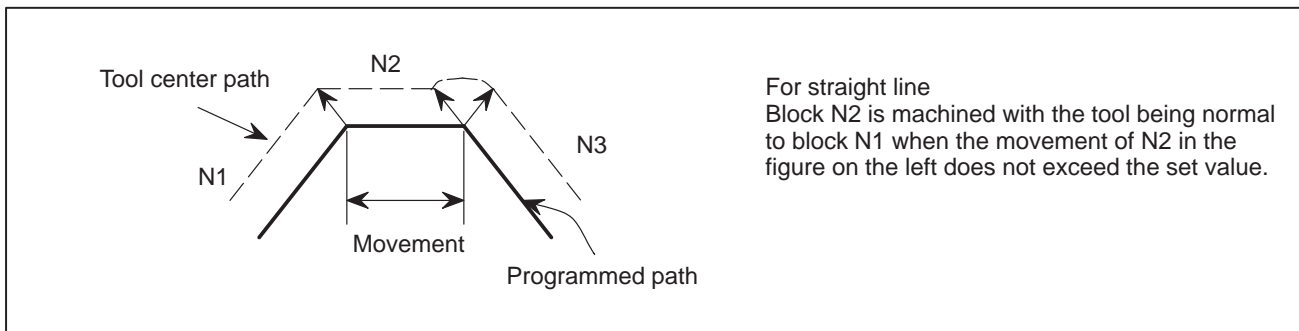

Fig.4.22 (a) When the Block Moves Along a Straight Line

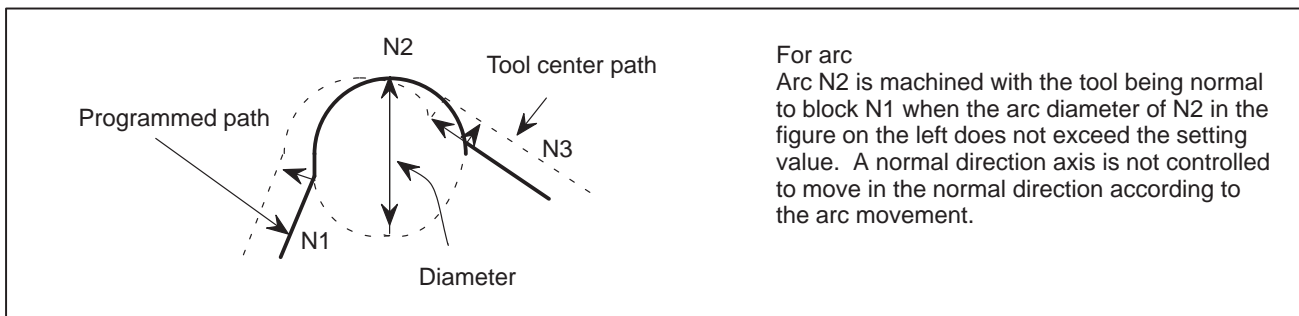

Fig.4.22 (b) When the Block Moves Along on Arc

4.23 PARAMETERS OF INDEXING INDEX TABLE

	#7	#6	#5	#4	#3	#2	#1	#0
5500				G90	INC	ABS	REL	DDP

[Data type] Bit type

- DDP** Selection of decimal–point input method of index table indexing axis
 0 : Conventional method (Example IS–B: B1; = 0.001 deg)
 1 : Pocket calculator method (Example IS–B: B1; = 1.000 deg)
- REL** Relative position display of index table indexing axis
 0 : Not rounded by 360 degrees
 1 : Rounded by 360 degrees
- ABS** Displaying absolute coordinate value of index table indexing axis
 0 : Not rounded by 360 degrees
 The index table indexing axis rotates 720 degrees (two rotations) when G90 B720.0; is specified from the 0–degree position. It rotates in reverse direction 720 degrees (two rotations) when G90 B0.; is specified. The absolute coordinate value then becomes 0 degree.
 1 : Rounded by 360 degrees
 The index table indexing axis is positioned in 40 degrees when G90 B400.0; is specified from the 0–degree position. The index table indexing axis does not rotate by two or more turns when this parameter is set to 1. It also does not move when G90 B720.0; is specified from the 0–degree position.
- INC** Rotation in the G90 mode when negative–direction rotation command M code (parameter No. 5511) is not set
 0 : Not set to the shorter way around the circumference
 1 : Set to the shorter way around the circumference (Set ABS, #2 of parameter No. 5500, to 1.)
- G90** Index table indexing command
 0 : Judged to be an absolute/increment command according to the G90/G91 mode
 1 : Judged to be an absolute command
- IDX** Index table indexing sequence
 0 : Type A
 1 : Type B

5511	Negative–direction rotation command M code
------	--------------------------------------------

[Data type] Byte

[Valid data range] 0 to 255

- 0 : Not use an M code that sets the index table rotation to the negative direction. The rotation direction is specified using a command and parameter (INC, #3 of parameter No. 5500).

1 to 255:

Sets an M code that sets the index table rotation to the negative direction. The rotation is set to the negative direction only when an M code set here is specified in the same block as an index table indexing command. If the M code is not specified in the same block, the rotation is always set to the positive direction.

Note

Set ABS, #2 of parameter No. 5500, to 1.

5512	
	Unit of index table indexing angle

[Data type] 2-word

[Unit of data]

Input increment	IS-A	IS-B	IS-C	Unit
Rotation axis	0.01	0.001	0.0001	deg

[Valid data range] 0 to 360000

This parameter sets the unit of index table indexing angle. A P/S alarm generated when movement other than integer multiple of the setting value is specified.

Note

If zero is specified as the setting value, any command can be specified irrespective of the unit of angle.

4.24 PARAMETER FOR INVOLUTE INTERPOLATION

5610 Limit of initial permissible error during involute interpolation

[Data type] 2-word

[Unit of data]

Increment system	IS-A	IS-B	IS-C	Unit
Metric input	0.01	0.001	0.0001	mm
Inch input	0.001	0.0001	0.00001	inch

[Valid data range] 0 to 99999999

This parameter sets the allowable limit of deviation between an involute curve passing through a start point and an involute curve passing through an end point for an involute interpolation command.

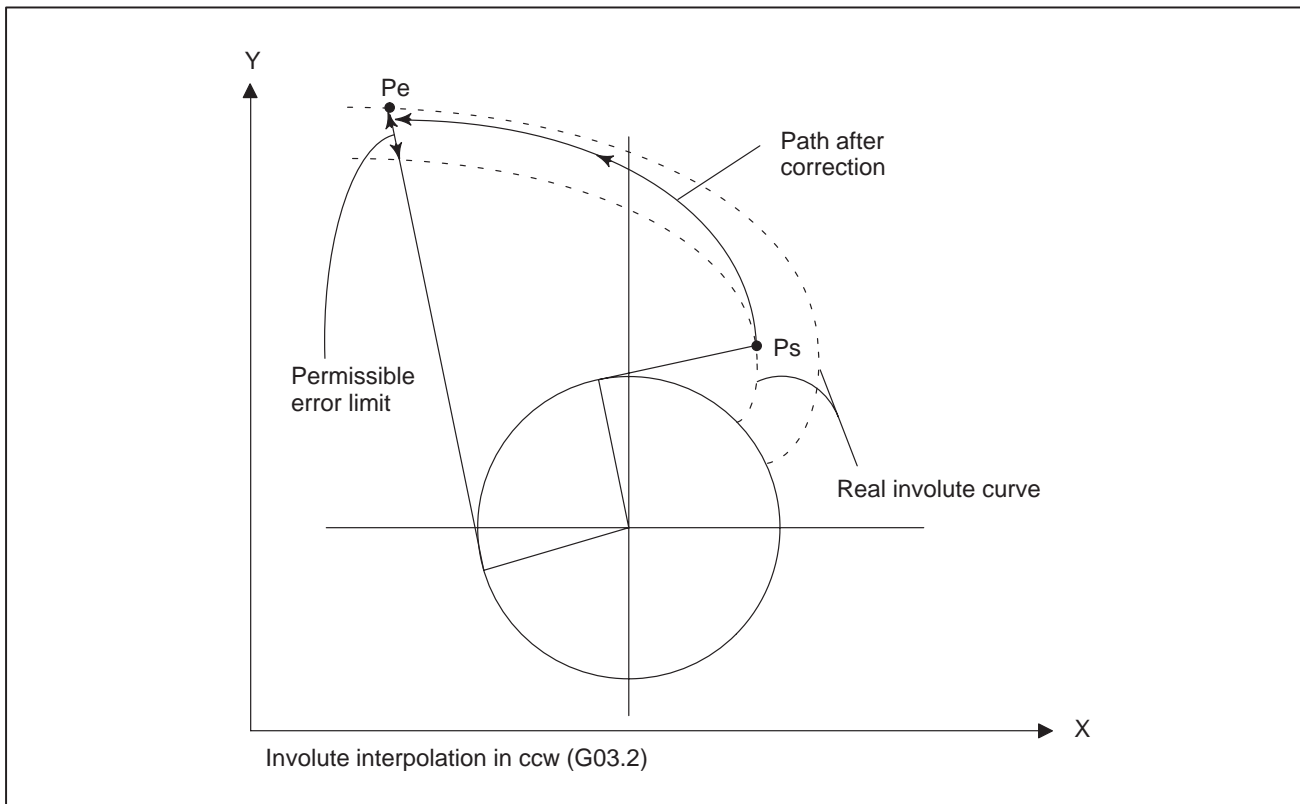

4.25 EXPONENTIAL INTERPOLATION PARAMETERS

	#7	#6	#5	#4	#3	#2	#1	#0
5630								SPN

[Data type] Bit type

SPN The amount of linear axis division (span value) in exponential interpolation is:

0 : Specified with parameter No. 5643.

1 : Specified using address K in a block containing G02.3/G03.3. When address K is not specified, the value set with parameter No. 5643 is used.

5641	Linear axis number subject to exponential interpolation
------	---------------------------------------------------------

[Data type] Byte type

[Valid data range] 1 to number of controlled axes

This parameter sets the ordinal number, among the controlled axes, for the linear axis to which exponential interpolation is applied.

5642	Rotation axis number subject exponential interpolation
------	--------------------------------------------------------

[Data type] Byte type

[Valid data range] 1 to number of controlled axes

This parameter sets the ordinal number, among the controlled axes, for the rotation axis to which exponential interpolation is applied.

5643	Amount of linear axis division (span value) in exponential interpolation
------	--------------------------------------------------------------------------

[Data type] 2-word type

[Valid data range]

Increment system	IS-A	IS-B	IS-C	Unit
Metric input	0.01	0.001	0.0001	mm
Inch input	0.001	0.0001	0.00001	inch

[Valid data range] 1 to 99999999

This parameter sets the amount of linear axis division in exponential interpolation when bit 0 (SPN) of parameter No. 5630 is set to 0.

4.26 STRAIGHTNESS COMPENSATION PARAMETERS

5711	Axis number of moving axis 1
5712	Axis number of moving axis 2
5713	Axis number of moving axis 3

[Data type] Byte type

[Unit of data] Axis number (When 0, compensation is not performed.)

[Valid data range] 1 to Number of controlled axes.
Set the axis numbers of moving axes.

5721	Axis number of compensation axis 1 for moving axis 1
5722	Axis number of compensation axis 2 for moving axis 2
5723	Axis number of compensation axis 3 for moving axis 3

[Data type] Byte type

[Unit of data] Axis number (When 0, compensation is not performed.)

[Valid data range] 1 to Number of controlled axes.
Set the axis numbers of compensation axes.

5731	Compensation point number a of moving axis 1
5732	Compensation point number b of moving axis 1
5733	Compensation point number c of moving axis 1
5734	Compensation point number d of moving axis 1
5741	Compensation point number a of moving axis 2
5742	Compensation point number b of moving axis 2
5743	Compensation point number c of moving axis 2
5744	Compensation point number d of moving axis 2
5751	Compensation point number a of moving axis 3
5752	Compensation point number b of moving axis 3
5753	Compensation point number c of moving axis 3
5754	Compensation point number d of moving axis 3

[Data type] Word type

[Unit of data] Number
(Compensation point numbers in stored pitch error compensation)

[Valid data range] 0 to 1023

Set four compensation point for each moving axis.

5761	Compensation corresponding compensation point number a of moving axis 1
5762	Compensation corresponding compensation point number b of moving axis 1
5763	Compensation corresponding compensation point number c of moving axis 1
5764	Compensation corresponding compensation point number d of moving axis 1
5771	Compensation corresponding compensation point number a of moving axis 2
5772	Compensation corresponding compensation point number b of moving axis 2
5773	Compensation corresponding compensation point number c of moving axis 2
5774	Compensation corresponding compensation point number d of moving axis 2
5781	Compensation corresponding compensation point number a of moving axis 3
5782	Compensation corresponding compensation point number b of moving axis 3
5783	Compensation corresponding compensation point number c of moving axis 3
5784	Compensation corresponding compensation point number d of moving axis 3

[Data type] Word type

[Unit of data] Detection unit

[Valid data range] -32768 to +32767

Note

Set compensation for each compensation point.

4.27 PARAMETERS OF CUSTOM MACROS

	#7	#6	#5	#4	#3	#2	#1	#0
6000			SBM					G67
			SBM		V15			G67

[Data type] Bit type

G67 If the macro continuous-state call cancel command (G67) is specified when the macro continuous-state call mode (G66) is not set:

0 : P/S alarm No. 122 is issued.

1 : The specification of G67 is ignored.

V15 As system variable numbers for tool offset:

0 : The standard system variable numbers for the Series 16 are used.

1 : The same system variable numbers as those used for the Series 15 are used.

The tables below indicate the system variables for tool offset numbers 1 to 999. The values for tool offset numbers 1 to 200 can be read from or assigned to the system variables in parentheses.

(1)

	System parameter number	
	V15 = 0	V15 = 1
Wear offset value	#10001 to #10999 (#2001 to #2200)	

(2)

	System parameter number	
	V15 = 0	V15 = 1
Geometry offset value	#11001 to #11999 (#2201 to #2400)	#10001 to #10999 (#2001 to #2200)
Wear offset value	#10001 to #10999 (#2001 to #2200)	#11001 to #11999 (#2201 to #2400)

(3)

		System parameter number	
		V15 = 0	V15 = 1
H-Code	Geometry offset value	#11001 to #11999 (#2201 to #2400)	#10001 to #10999 (#2001 to #2200)
	Wear offset value	#10001 to #10999 (#2001 to #2200)	#11001 to #11999 (#2201 to #2400)
D-Code	Geometry offset value	#13001 to #13999	#12001 to #12999
	Wear offset value	#12001 to #12999	#13001 to #13999

SBM Custom macro statement
 0: Not stop the single block
 1: Stops the single block

When parameter No. 3404 #0 NOP = 1, it becomes invalid.

	#7	#6	#5	#4	#3	#2	#1	#0
6001	CLV	CCV	TCS	CRO	PV5		PRT	

PRT Reading zero when data is output using a DPRINT command
 0 : Outputs a space
 1 : Outputs no data

PV5 Custom macro common variables:
 0 : Nos. 500 to 599 are output.
 1 : Nos. 100 to 199 and Nos. 500 to 599 are output.

CRO ISO code in BPRWT or DPRNT command
 0 : Outputs only LF after data is output
 1 : Outputs LF and CR after data is output

TCS Custom macro (subprogram)
 0 : Not called using a T code
 1 : Called using a T code

CCV Custom macro's common variables Nos. 100 through 149
 0: Cleared to "vacant" by reset
 1: Not cleared by reset

CLV Custom macro's local variables Nos. 1 through 33
 0: Cleared to "vacant" by reset
 1: Not cleared by reset

	#7	#6	#5	#4	#3	#2	#1	#0
6003	MUS	MCY	MSB	MPR	TSE	MIN	MSK	

Note

When this parameter is set, the power must be turned off before operation is continued.

[Data type] Bit

MSK Absolute coordinates at that time during custom macro interrupt
 0 : Not set to the skip coordinates (system variables #5061 and later)
 1 : Set to the skip coordinates (system variables #5601 and later)

MIN Custom macro interrupt
 0 : Performed by interrupting an in-execution block (Custom macro interrupt type I)
 1 : Performed after an in-execution block is completed (Custom macro interrupt type II)

TSE Custom macro interrupt signal UINT
 0 : Edge trigger method (Rising edge)
 1 : Status trigger method

- MPR** Custom macro interrupt valid/invalid M code
 0 : M96/M97
 1 : M code set using parameters (Nos. 6033 and 6034)
- MSB** Interrupt program
 0 : Uses a dedicated local variable (Macro-type interrupt)
 1 : Uses the same local variable as in the main program (Subprogram-type interrupt)
- MCY** Custom macro interrupt
 0 : Not performed during cycle operation
 1 : Performed during cycle operation
- MUS** Interrupt-type custom macro
 0 : Not used
 1 : Used

	#7	#6	#5	#4	#3	#2	#1	#0
6010	*7	*6	*5	*4	*3	*2	*1	*0
6011	=7	=6	=5	=4	=3	=2	=1	=0
6012	#7	#6	#5	#4	#3	#2	#1	#0
6013	[7	[6	[5	[4	[3	[2	[1	[0
6014]7]6]5]4]3]2]1]0

[Data type] Bit type

These parameters are used to input/output macro statements.
 *0 to *7 : Set the hole pattern of an EIA code indicating *.
 =0 to =7 : Set the hole pattern of an EIA code indicating =.
 #0 to #7 : Set the hole pattern of an EIA code indicating #.
 [0 to [7 : Set the hole pattern of an EIA code indicating [.
] 0 to] 7 : Set the hole pattern of an EIA code indicating].
 0 : Corresponding bit is 0
 1 : Corresponding bit is 1.

Note
 The numeral of a suffix indicates the bit position in a code.

6030	M code that calls the program entered in file
------	-----------------------------------------------

[Data type] Byte

[Valid data range] 0, and 1 to 255

This parameter sets an M code that calls the program entered in a file.

Note
 The M code is judged to be M198 when zero is specified as the setting value.

6033	M code that validates a custom macro interrupt
6034	M code that invalidates a custom macro interrupt

[Data type] Byte type

[Valid data range] 0 to 255

These parameters set the custom macro interrupt valid/invalid M codes.

Note

These parameters can be used when MPR, #4 of parameter No. 6003, is 1. M96 is used as a valid M code and M97 is used as an invalid M code when MPR is 0, irrespective of the state of this parameter.

6036	Number of custom macro variables common to tool posts (#100's)
------	----------------------------------------------------------------

[Data type] Byte

[Unit of data] Number of custom macro variables

[Valid data range] 0 to 50

The parameter specifies the number of variables commonly used for both tool paths 1 and 2 (custom macro variables common to tool paths) that are included in custom macro variables 100 to 149.

The custom macro variables common to tool paths can be written from or read into either of the tool paths.

Examples

When this parameter is set to 10, the custom macro variables are specified as follows:

Custom macro variables 100 to 109: Used commonly between two paths

Custom macro variables 110 to 149: Used independently for each path

Note

- 1 This parameter is dedicated to the 2-path control.
- 2 When this parameter is set to 0, custom macro variables 100 to 149 are not used commonly between two paths.
- 3 Custom macro variables that can be used as custom macro variables common between two paths are from 100 to 149. Custom macro variable 150 and subsequent custom macro variables cannot be used commonly between two paths, even if this parameter is set to 51 or more.

6037	Number of custom macro variables common to tool posts (#500's)
------	----------------------------------------------------------------

[Data type] Byte

[Unit of data] Number of custom macro variables

[Valid data range] 0 to 32

Examples

When this parameter is set to 10, the custom macro variables are specified as follows:

Custom macro variables 500 to 509: Used commonly between two paths

Custom macro variables 510 to 531: Used independently for each path

Note

- 1 This parameter is dedicated to the 2-path control.
- 2 When this parameter is set to 0, custom macro variables 500 to 531 are not used commonly between two paths.
- 3 Custom macro variables that can be used as custom macro variables common between two paths are from 500 to 531. Custom macro variable 532 and subsequent custom macro variables cannot be used commonly for both tool posts, even if this parameter is set to 33 or more.

6050	G code that calls the custom macro of program number 9010
6051	G code that calls the custom macro of program number 9011
6052	G code that calls the custom macro of program number 9012
6053	G code that calls the custom macro of program number 9013
6054	G code that calls the custom macro of program number 9014
6055	G code that calls the custom macro of program number 9015
6056	G code that calls the custom macro of program number 9016
6057	G code that calls the custom macro of program number 9017
6058	G code that calls the custom macro of program number 9018
6059	G code that calls the custom macro of program number 9019

[Data type] Word type

[Valid data range] 1 to 9999

These parameters set the G codes that call the custom macros of program numbers 9010 through 9019.

Note

Setting value 0 is invalid. No custom macro can be called by G00.

6071	M code that calls the subprogram of program number 9001
6072	M code that calls the subprogram of program number 9002
6073	M code that calls the subprogram of program number 9003
⋮	⋮
6079	M code that calls the subprogram of program number 9009

[Data type] 2–word type

[Valid data range] 1 to 99999999

These parameters set the M codes that call the subprograms of program numbers 9001 through 9009.

Note

Setting value 0 is invalid. No custom macro can be called by M00.

6080	M code that calls the custom macro of program number 9020
6081	M code that calls the custom macro of program number 9021
6082	M code that calls the custom macro of program number 9022
6083	M code that calls the custom macro of program number 9023
6084	M code that calls the custom macro of program number 9024
6085	M code that calls the custom macro of program number 9025
6086	M code that calls the custom macro of program number 9026
6087	M code that calls the custom macro of program number 9027
6088	M code that calls the custom macro of program number 9028
6089	M code that calls the custom macro of program number 9029

[Data type] 2–word type

[Valid data range] 1 to 99999999

These parameters set the M codes that call the custom macros of program numbers 9020 through 9029.

Note

Setting value 0 is invalid. No custom macro can be called by M00.

6090	ASCII code that calls the subprogram of program number 9004
6091	ASCII code that calls the subprogram of program number 9005

Note

When this parameter is set, the power must be turned off before operation is continued.

[Data type] Byte type

[Valid data range] 65 (A:41H) to 90 (Z:5AH)

These parameters set the ASCII codes that call subprograms in decimal.

Addresses that can be used are as follows:

T series : A, B, F, H, I, K, M, P, Q, R, S, T

M series: A, B, D, F, H, I, J, K, L, M, P, Q, R, S, T, X, Y, Z

Note

Set 0 when no subprogram is called

4.28 PARAMETERS RELATED TO PATTERN DATA INPUT

6101	First variable number displayed on pattern data screen 1
6102	First variable number displayed on pattern data screen 2
6103	First variable number displayed on pattern data screen 3
6104	First variable number displayed on pattern data screen 4
6105	First variable number displayed on pattern data screen 5
6106	First variable number displayed on pattern data screen 6
6107	First variable number displayed on pattern data screen 7
6108	First variable number displayed on pattern data screen 8
6109	First variable number displayed on pattern data screen 9
6110	First variable number displayed on pattern data screen 10

[Data type] Word type

[Valid data range] 0, 100 to 199, 500 to 999

These parameters specify the first variable number displayed on the pattern data screen selected from the pattern menu screen. When 0 is set, 500 is assumed.

4.29 PARAMETER OF SKIP FUNCTION

Parameter

	#7	#6	#5	#4	#3	#2	#1	#0
6200	SKF	SRE	SLS	HSS	MIT		SK0	GSK
	SKF	SRE	SLS	HSS			SK0	

[Data type] Bit type

- GSK** In skip cutting (G31), the signal SKIPP (bit 6 of G006) is:
 0 : Not used as a skip signal.
 1 : Used as a skip signal.
- SK0** This parameter specifies whether the skip signal is made valid under the state of the skip signal SKIP (bit 7 of X004) and the multistage skip signals (bits 0 to 7 of X004) (for the T series only).
 0 : Skip signal is valid when these signals are 1.
 1 : Skip signal is valid when these signals are 0.
- MIT** In skip cutting (G31), the tool compensation measurement value direct input B signals +MIT1, -MIT1, +MIT2, and =MIT2 (bit 2 to 5 of X004) are :
 0 : Not used as skip signals.
 1 : Used as skip signals.
- HSS** 0 : The skip function does not use high-speed skip signals.
 1 : The skip function uses high-speed skip signals.
- SLS** 0 The multi-step skip function does not use high-speed skip signals while skip signals are input.
 1 : The multi-step skip function uses high-speed skip signals while skip signals are input.
- SRE** When a high-speed skip signal is used:
 0 : The signal is considered to be input at the rising edge (0 → 1).
 1 : The signal is considered to be input at the falling edge (1 → 0).
- SKF** Dry run, override, and automatic acceleration/deceleration for G31 skip command
 0 : Disabled
 1 : Enabled

	#7	#6	#5	#4	#3	#2	#1	#0
6201				IGX	TSA	TSE	SEB	SEA
			CSE	IGX			SEB	SEA

[Data type] Bit

- SEA** When a high speed skip signal goes on while the skip function is used, acceleration/deceleration and servo delay are:
 0 : Ignored.
 1 : Considered and compensated (type A).
- SEB** When a high speed skip signal goes on while the skip function is used, acceleration/deceleration and servo delay are:
 0 : Ignored.
 1 : Considered and compensated (type B).

Note

There are two types of compensation: Types A and B. With the skip function, the current position is stored in the NC according to the skip signal. However, the current position stored in the NC contains servo delay. The machine position is therefore deviated by the servo delay. The deviation can be obtained from the position deviation of the servo and the error generated due to feedrate acceleration/deceleration performed by the NC. If the deviation can be compensated, it is not necessary to include the servo delay in measurement errors. The deviation can be compensated with the following two types by the parameter as follows:

- (1) Type A: The deviation is the value calculated from the cutting time constant and servo time constant (loop gain).
- (2) Type B: The deviation is the error due to acceleration/deceleration and the position deviation when the skip signal goes on.

TSE When the skip function, based on the torque limit arrival signal is used, the skip position stored in a system variable is :

0 : An offset position reflecting a servo system delay (positional deviation).

1 : A position independent of a servo system delay.

Note

The skip function based on the torque limit arrival signal stores the current position within the CNC when the torque limit arrival signal is turned on. However, the current position within the CNC includes a servo system delay, causing that position to be shifted from the machine position by an amount equal to the servo delay. This amount of shift can be found from the positional deviation on the servo side. When TSE = 0, a skip position is determined to be the current position, less the positional deviation. When TSE = 1, the skip position is determined to be the current position (including a servo system delay), independent of the shift equal to the positional deviation.

TSA When the skip function, based on the torque limit arrival signal is used, torque limit arrival is monitored for :

0 : All axes.

1 : Only those axes that are specified in a block containing G31.

IGX When the high-speed skip function is used, SKIP (bit 7 of X004), SKIPP (bit 6 of G006), and +MIT1 to -MIT2 (bits 2 to 5 of X004) are:

0 : Enabled as skip signals.

1 : Disabled as skip signals.

Note

- 1 SKIPP (bit 6 of G006) and +MIT1 to –MIT2 (bits 2 to 5 of X004) are enabled only when bit 0 (GSK) of parameter No. 6200 is set to 1 and bit 3 (MIT) of parameter No. 6200 is set to 1. Note also that these signals are enabled only for the T series.
- 2 The skip signals for the multistage skip function (SKIP, SKIP2 to SKIP8) can also be disabled.

CSE For continuous high-speed skip command G31 P90, high-speed skip signals are :

0 : Effective at either a rising or falling edge (depending on the setting of bit 6 (SRE) of parameter 6200)

1 : Effective for both the rising and falling edges

	#7	#6	#5	#4	#3	#2	#1	#0
6202	1S8	1S7	1S6	1S5	1S4	1S3	1S2	1S1
6203	2S8	2S7	2S6	2S5	2S4	2S3	2S2	2S1
6204	3S8	3S7	3S6	3S5	3S4	3S3	3S2	3S1
6205	4S8	4S7	4S6	4S5	4S4	4S3	4S2	4S1
6206	DS8	DS7	DS6	DS5	DS4	DS3	DS2	DS1

[Data type] Bit type

1S1 to 1S8 Specify which high-speed skip signal is enabled when the G31 skip command is issued. The bits correspond to the following signals:

- 1S1 — HDI0
- 1S2 — HDI1
- 1S3 — HDI2
- 1S4 — HDI3
- 1S5 — HDI4
- 1S6 — HDI5
- 1S7 — HDI6
- 1S8 — HDI7

1S1 to 1S8, 2S1 to 2S8, 3S1 to 3S8, 4S1 to 4S8, DS1 to DS8

Specify which skip signal is enabled when the skip command (G31, or G31P1 to G31P4) and the dwell command (G04, G04Q1 to G04Q4) are issued with the multi-step skip function.

The following table shows the correspondence between the bits, input signals, and commands.

The setting of the bits have the following meaning :

0 : The skip signal corresponding to the bit is disabled.

1 : The skip signal corresponding to the bit is enabled.

Multi-speed skip function	
Command	G31
Input signal	
HDI0	1S1
HDI1	1S2
HDI2	1S3
HDI3	1S4
HDI4	1S5
HDI5	1S6
HDI6	1S7
HDI7	1S8

Multi-step skip function					
Command	G31 G31P1 G04Q1	G31P2 G04Q2	G31P2 G04Q2	G31P4 G04Q4	G04
Input signal					
SKIP/HDI0	1S1	2S1	3S1	4S1	DS1
SKIP2/HDI1	1S2	2S2	3S2	4S2	DS2
SKIP3/HDI2	1S3	2S3	3S3	4S3	DS3
SKIP4/HDI3	1S4	2S4	3S4	4S4	DS4
SKIP5/HDI4	1S5	2S5	3S5	4S5	DS5
SKIP6/HDI5	1S6	2S6	3S6	4S6	DS6
SKIP7/HDI6	1S7	2S7	3S7	4S7	DS7
SKIP8/HDI7	1S8	2S8	3S8	4S8	DS8

Note

HDI0 to HDI7 are high-speed skip signals.

	#7	#6	#5	#4	#3	#2	#1	#0
6207								IOC

Note

When this parameter has been set, the power must be turned off before operation is continued.

[Data type] Bit type

IOC For the high-speed skip input signal HDIn:

0 : The option 2 board is used.

1 : An I/O card is used.

	#7	#6	#5	#4	#3	#2	#1	#0
6208	9S8	9S7	9S6	9S5	9S4	9S3	9S2	9S1

[Data type] Bit type

9S1 to 9S8 Specify valid high-speed skip signals for high-speed skip command G31P90. The bits correspond to signals as follows:

9S1	—	HDI0
9S2	—	HDI1
9S3	—	HDI2
9S4	—	HDI3
9S5	—	HDI4
9S6	—	HDI5
9S7	—	HDI6
9S8	—	HDI7

Set each bit as follows:

0 : The corresponding skip signal is invalid.

1 : The corresponding skip signal is valid.

6220	
	Period during which input is ignored for continuous high-speed skip signal

[Data type] Byte type

[Unit of data] 8 ms

[Valid data range] 3 to 127 (× 8 ms)

If a value that falls outside this range is specified, 3 (× 8 ms) is assumed. This parameter specifies the period that must elapse between a high-speed skip signal being input and input of the next high-speed skip signal being enabled, for the continuous high-speed skip function. This parameter is used to ignore chattering in skip signals.

4.30 PARAMETERS OF AUTOMATIC TOOL COMPENSATION (16-TB) AND AUTOMATIC TOOL LENGTH COMPENSATION (16-MB)

	#7	#6	#5	#4	#3	#2	#1	#0
6240								AE0

[Data type] Bit type

AE0 Measurement position arrival is assumed when the automatic tool compensation signals XAE and ZAE (bits 0 and 1 of X004) (T system) or the automatic tool length measurement signals XAE, YAE, and ZAE (bits 0, 1, and 2 of X004) (M system) are:

0 : 1
1 : 0

6241	Feedrate during measurement of automatic tool compensation
	Feedrate during measurement of automatic tool length compensation

[Data type] Word type

Increment system	Unit of data	Valid data range	
		IS-A, IS-B	IS-C
Millimeter machine	1 mm/min	6 to 15000	6 to 12000
Inch machine	0.1 inch/min	6 to 6000	6 to 4800
Rotation axis	1 deg/min	6 to 15000	6 to 12000

This parameter sets the feedrate during measurement of automatic tool compensation (T series) and automatic tool length compensation (M series).

6251	γ value on X axis during automatic tool compensation
	γ value during automatic tool length automatic compensation

6252	γ value on Z axis during automatic tool compensation
------	-------------------------------------------------------------

[Data type] 2-word type

[Unit of data]

Increment system	IS-A	IS-B	IS-C	Unit
Metric input	0.01	0.001	0.0001	mm
Inch input	0.001	0.0001	0.00001	inch

[Valid data range] 1 to 99999999

These parameters set the ϵ value during automatic tool compensation (T series) or tool length automatic compensation (M series).

Note

Set a radius value irrespective of whether the diameter programming or the radius programming is specified.

6254	ϵ value on X axis during automatic tool compensation
	ϵ value during automatic tool length automatic compensation
6255	ϵ value on Z axis during automatic tool compensation

[Data type] 2–word type

[Unit of data]

Increment system	IS–A	IS–B	IS–C	Unit
Millimeter machine	0.01	0.001	0.0001	mm
Inch machine	0.001	0.0001	0.00001	inch

[Valid data range] 1 to 99999999

These parameters set the ϵ value during automatic tool compensation (T series) or automatic tool length offset (M series).

Note

Set a radius value irrespective of whether the diameter programming or the radius programming is specified.

4.31 PARAMETER OF EXTERNAL DATA INPUT/OUTPUT

	#7	#6	#5	#4	#3	#2	#1	#0
6300				ESR				

[Data type] Bit type

ESR External program number search
 0 : Disabled
 1 : Enabled

4.32 PARAMETERS OF GRAPHIC DISPLAY

	#7	#6	#5	#4	#3	#2	#1	#0
6500		NZM			DPA	GUL	SPC	GRL
			DPO					

[Data type] Bit

GRL Graphic display (2-path control)
 0 : Tool post 1 is displayed on the left, and tool post 2 is displayed on the right.
 1 : Tool post 1 is displayed on the right, and tool post 2 is displayed on the left.

SPC Graphic display (2-path control) is done
 0 : on two spindles and two tool posts
 1 : on one spindle and two tool posts

GUL 0 : The positions of X1- and X2-axes are not replaced with each other in the coordinate system specified with parameter 6509. (2-path control)
 1 : The positions of X1- and X2-axes are replaced with each other in the coordinate system specified with parameter 6509. (2-path control)

DPA Current position display on the graphic display screen
 0 : Displays the actual position to ensure tool nose radius compensation
 1 : Displays the programmed position

DPO Current position on the solid drawing (machining profile drawing) or tool path drawing screen
 0 : Not appear
 1 : Appears

NZM 0 : The screen image is not enlarged by specifying the center of the screen and magnification. (Screen image enlargement by a conventional method is enabled.)
 1 : The screen image is enlarged by specifying the center of the screen and magnification. (Screen image enlargement by the conventional method is disabled.)

	#7	#6	#5	#4	#3	#2	#1	#0
6501			CSR					
			CSR	FIM	RID	3PL	TLC	ORG

[Data type] Bit

ORG Movement when coordinate system is altered during drawing
 0 : Draws in the same coordinate system
 1 : Draws in the new coordinate system (only for the path drawing)

TLC In solid drawing
 0 : Not compensate the tool length
 1 : Compensates the tool length

3PL Tri-plane drawing in solid drawing
 0 : Drawn by the first angle projection
 1 : Drawn by the third angle projection

RID In solid drawing
 0 : Draws a plane without edges.
 1 : Draws a plane with edges.

FIM Machining profile drawing in solid drawing
 0 : Displayed in the coarse mode
 1 : Displayed in the fine mode

CSR While the screen image is enlarged, the shape of the graphic cursor is:
 0 : A square.
 1 : An X.

6509	Coordinate system for drawing a single spindle (2-path control)

[Data type] Byte

[Valid data range] 0 to 7 and 10 to 17 (However, 0 to 7 are the same settings as 10 to 17.)

This parameter sets the coordinate system for drawing a single spindle (bit 1 of parameter 6500 = 1) for 2-path control.

The following shows the relationship between the settings and the drawing coordinate systems:

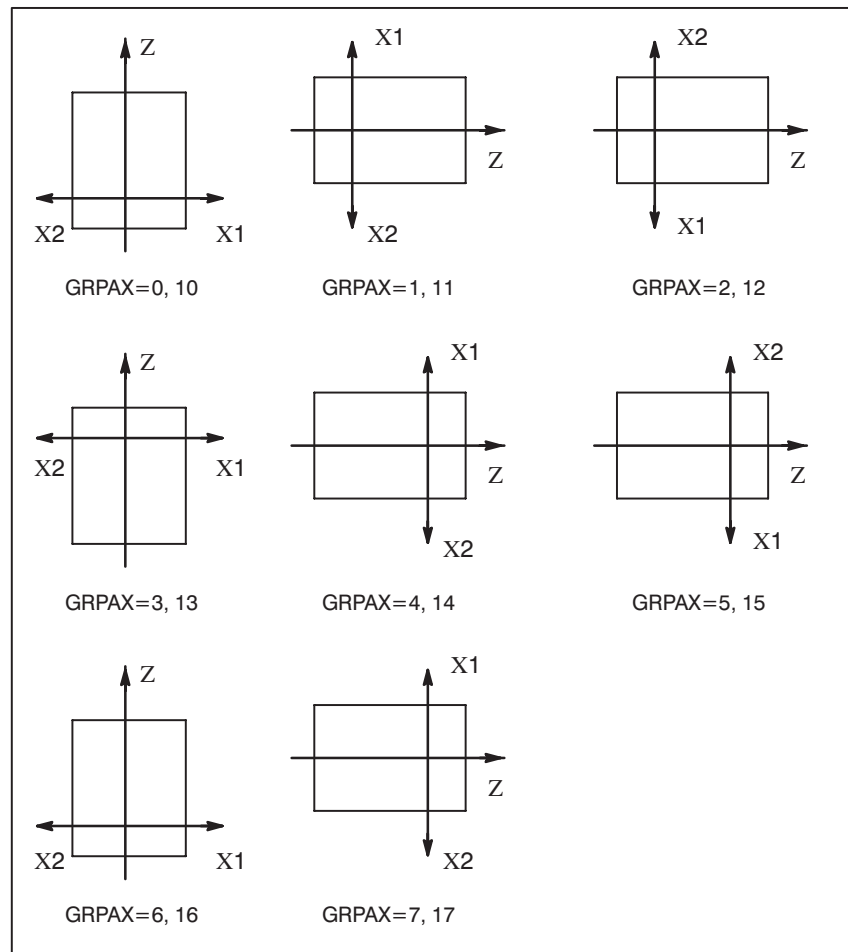

6510	Drawing coordinate system
------	---------------------------

[Data type] Byte

[Valid data range] 0 to 7

This parameter specifies the drawing coordinate system for the graphic function.

The following show the relationship between the set values and the drawing coordinate systems.

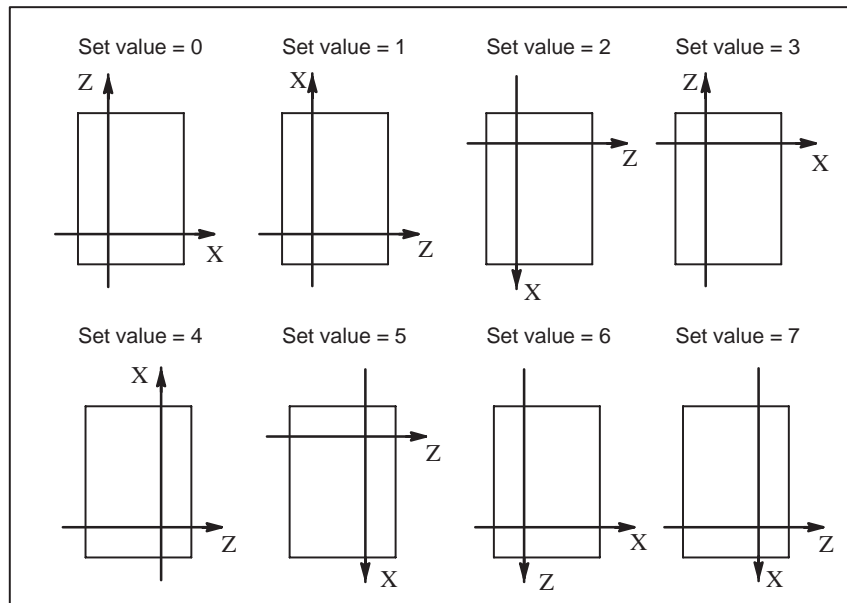

Note

This parameter is specified for each tool post in the 2-path control. A different drawing coordinate system can be selected for each tool post.

6511	Right margin in solid drawing
6512	Left margin in solid drawing
6513	Upper margin in solid drawing
6514	Lower margin in solid drawing

[Data type] Word

[Unit of data] Dot

These parameters set the machining profile drawing position in margins on the CRT screen. The unit is a dot.

Parameter No.	Margin area	Standard set value			
		DPO=0		DPO=1	
		9" CRT	14" CRT	9" CRT	14" CRT
6511	Right	0	0	200	100
6512	Left	0	0	0	0
6513	Upper	25	32	25	32
6514	Lower	0	10	0	10

Set DPO with parameter No. 6500#5.

6515	
	Change in cross-section position in tri-plane drawing

[Data type] Byte type

[Unit of data] Dot

[Valid data range] 0 to 10

This parameter sets the change in the cross-section position when a soft key is continuously pressed in tri-plane drawing. When zero is specified, it is set to 1.

6520	C-axis number for dynamic graphic display

[Data type] Byte type

[Valid data range] 0, 1 to number of controlled axes

This parameter sets a C-axis number for dynamic graphic display. When 0 or a value greater than the number of controlled axes is specified with this parameter, the third axis is assumed.

4.33 PARAMETERS OF DISPLAYING OPERATION TIME AND NUMBER OF PARTS

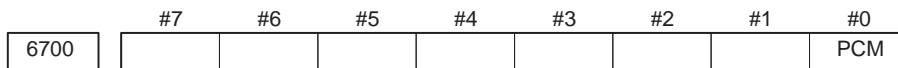

[Data type] Bit

PCM M code that counts the total number of machined parts and the number of machined parts
 0 : M02, or M30, or an M code specified by parameter No. 6710
 1 : Only M code specified by parameter No. 6710

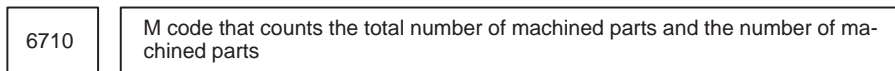

[Data type] Byte

[Valid data range] 0 to 255 except 98 and 99

The total number of machined parts and the number of machined parts are counted (+1) when the M code set is executed.

Note
 Set value 0 is invalid (the number of parts is not counted for M00). Data 98 and 99 cannot be set.

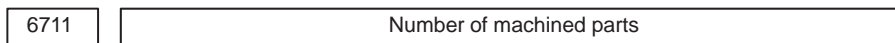

Setting entry is acceptable.

[Data type] 2-word

[Unit of data] One piece

[Valid data range] 0 to 99999999

The number of machined parts is counted (+1) together with the total number of machined parts when the M02, M30, or a M code specified by parameter No. 6710 is executed.

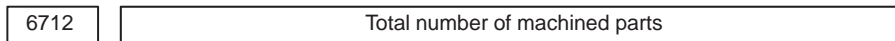

Setting entry is acceptable.

[Data type] 2-word

[Unit of data] One piece

[Valid data range] 0 to 99999999

This parameter sets the total number of machined parts.

The total number of machined parts is counted (+1) when M02, M30, or an M code specified by parameter No. 6710 is executed.

6713	Number of required parts
------	--------------------------

Setting entry is acceptable.

[Data type] Word

[Unit of data] One piece

[Valid data range] 0 to 9999

This parameter sets the number of required machined parts.

Required parts finish signal PRTSF is output to PMC when the number of machined parts reaches the number of required parts. The number of parts is regarded as infinity when the number of required parts is zero. The PRTSF signal is then not output.

6750	Integrated value of power-on period
------	-------------------------------------

Setting entry is acceptable.

[Data type] 2-word

[Unit of data] One minute

[Valid data range] 0 to 99999999

This parameter displays the integrated value of power-on period.

6751	Operation time (integrated value of time during automatic operation)
------	----------------------------------------------------------------------

Setting entry is acceptable.

[Data type] 2-word

[Unit of data] One ms

[Valid data range] 0 to 60000

6752	Operation time (integrated value of time during automatic operation)
------	----------------------------------------------------------------------

Setting entry is acceptable.

[Data type] 2-word

[Unit of data] One minute

[Valid data range] 0 to 99999999

This parameter displays the integrated value of time during automatic operation (neither stop nor hold time included).

6753	Integrated value of cutting time
------	----------------------------------

Setting entry is acceptable.

[Data type] 2-word

[Unit of data] One ms

[Valid data range] 1 to 60000

6754

Integrated value of cutting time

Setting entry is acceptable.

[Data type] 2-word**[Unit of data]** One minute**[Valid data range]** 0 to 99999999

This parameter displays the integrated value of a cutting time that is performed in cutting feed such as linear interpolation (G01) and circular interpolation (G02 or G03).

6755

Integrated value of general-purpose integrating meter drive signal (TMRON) ON time

Setting entry is acceptable.

[Data type] 2-word**[Unit of data]** One ms**[Valid data range]** 0 to 60000

6756

Integrated value of general-purpose integrating meter drive signal (TMRON) ON time

Setting entry is acceptable.

[Data type] 2-word**[Unit of data]** One minute**[Valid data range]** 0 to 99999999

This parameter displays the integrated value of a time while input signal TMRON from PMC is on.

6757

Operation time (integrated value of one automatic operation time)

Setting entry is acceptable.

[Data type] 2-word**[Unit of data]** One ms**[Valid data range]** 0 to 60000

6758

Operation time (integrated value of one automatic operation time)

Setting entry is acceptable.

[Data type] 2-word**[Unit of data]** One minute**[Valid data range]** 0 to 99999999

This parameter displays the one automatic operation drive time (neither stop nor hold state included). The operation time is automatically preset to 0 during the power-on sequence and the cycle start from the reset state.

4.34 PARAMETERS OF TOOL LIFE MANAGEMENT

6800	#7	#6	#5	#4	#3	#2	#1	#0
	M6T	IGI	SNG	GRS	SIG	LTM	GS2	GS1

[Data type] Bit

GS1, GS2 This parameter sets the combination of the number of tool life groups which can be entered, and the number of tools which can be entered per group as shown in the table below.

GS2	GS1	M series		T series	
		Group count	Tool count	Group count	Tool count
0	0	1-16 1-64	1-16 1-32	1-16 1-16	1-16 1-32
0	1	1-32 1-28	1-8 1-16	1-32 1-32	1-8 1-16
1	0	1-64 1-256	1-4 1-8	1-64 1-64	1-4 1-8
1	1	1-128 1-512	1-2 1-4	1-16 1-128	1-16 1-4

The values on the lower row in the table apply when for the M series, the 512-tool-life-management-group option is provided, and for the T series, the 128-tool-life-management-group option is provided.

LTM Tool life

0 : Specified by the number of times

1 : Specified by time

SIG Group number is

0 : Not input using the tool group signal during tool skip (The current group is specified.)

1 : Input using the tool group signal during tool skip

GRS Tool exchange reset signal

0 : Clears only the execution data of a specified group

1 : Clears the execution data of all entered groups

SNG Input of the tool skip signal when a tool that is not considered tool life management is selected.

0 : Skips the tool of the group used last or of the specified group (using SIG, #3 of parameter No. 6800).

1 : Ignores a tool skip signal

IGI Tool back number

0 : Not ignored

1 : Ignored

M6T T code in the same block as M06

0 : Judged as a back number

1 : Judged as a next tool group command

	#7	#6	#5	#4	#3	#2	#1	#0
6801		EXG	EIS				TSM	
	M6E	EXT	EIS		EMD	LFV		CUT

[Data type] Bit

- CUT** The tool life management using cutting distance is
0 : Not performed (Usually set this parameter to 0).
1 : Performed
- TSM** When a tool takes several tool numbers, life is counted in tool life management:
0 : For each of the same tool numbers.
1 : For each tool.
- LFV** Specifies whether life count override is enabled or disabled when the extended tool life management function is used.
0 : Disabled
1 : Enabled
- EMD** An asterisk (*) indicating that a tool has been expired is displayed,
0 : When the next tool is selected
1 : When the tool life is expired
- EIS** When the life of a tool is measured in time-based units:
0 : The life is counted every four seconds.
1 : The life is counted every second.

Note

This parameter is valid when bit 2 (LTM) of parameter No. 6800 is set to 1.

- EXT** Specifies whether the extended tool life management function is used.
0 : Not used
1 : Used
- EXG** Tool life management data registration by G10 (T system) is:
0 : Performed after the data for all tool groups has been cleared.
1 : Performed by adding/changing or deleting the data for a specified group.

Note

When EXG = 1, address P in the block including G10 can be used to specify whether data is to be added/changed or deleted (P1: add/change, P2: delete). When P is not specified, the data for all tool groups is cleared before the tool life management data is registered.

- M6E** When a T code is specified in the same block as M06
0 : The T code is processed as a return number or as a group number selected next. Either is set by parameter M6T No. 6800#7.
1 : The tool group life is counted immediately.

6810	
	Tool life management ignored number

[Data type] Word

[Valid data range] 0 to 9999

This parameter sets the tool life management ignored number.

When the set value is subtracted from a T code, a remainder is used as the tool group number of tool life management when a value exceeding the set value is specified in the T code.

6811	Tool life count restart M code

[Data type] Byte

[Valid data range] 0 to 255 (not including 01, 02, 30, 98, and 99)

When zero is specified, it is ignored.

When the life is specified by the number of times, the tool exchange signal is output when a tool life count restart M code is specified if tool life of at least one tool group is expired. A tool in life is selected in the specified group when a T code command (tool group command) is specified after the tool life count restart M code is specified. A tool life counter is then incremented by one.

When the life is specified by time, a tool in life is selected in the specified group when a T code command (tool group command) is specified after the tool life count restart M code is specified.

4.35 PARAMETERS OF POSITION SWITCH FUNCTIONS

	#7	#6	#5	#4	#3	#2	#1	#0
6901								IGP

[Data type] Bit type

IGP During follow-up for the absolute position detector, position switch signals are:

0 : Output

1 : Not output

6910	Axis corresponding to the first position switch
6911	Axis corresponding to the second position switch
6912	Axis corresponding to the third position switch
6913	Axis corresponding to the fourth position switch
6914	Axis corresponding to the fifth position switch
6915	Axis corresponding to the sixth position switch
6916	Axis corresponding to the seventh position switch
6917	Axis corresponding to the eighth position switch
6918	Axis corresponding to the ninth position switch
6919	Axis corresponding to the tenth position switch

[Data type] Byte

[Valid data range] 1, 2, 3, . . . , control axis count

These parameters specify the control-axes numbers corresponding to the first through tenth position switch functions. A corresponding position switch signal is output to PMC when the machine coordinate value of a corresponding axis is within the range that is set using a parameter.

Note

Set 0 for those position switch numbers that are not to be used.

6930	Maximum operation range of the first position switch
6931	Maximum operation range of the second position switch
6932	Maximum operation range of the third position switch
6933	Maximum operation range of the fourth position switch
6934	Maximum operation range of the fifth position switch
6935	Maximum operation range of the sixth position switch
6936	Maximum operation range of the seventh position switch
6937	Maximum operation range of the eighth position switch
6938	Maximum operation range of the ninth position switch
6939	Maximum operation range of the tenth position switch

[Data type] 2-word

[Unit of data]

Increment system	IS-A	IS-B	IS-C	Unit
Metric input	0.01	0.001	0.0001	mm
Inch machine	0.001	0.0001	0.00001	inch
Rotation axis	0.01	0.001	0.0001	deg

[Valid data range] 0 to ± 99999999

These parameters set the maximum operation range of the first through tenth position switches.

6950	Minimum operation range of the first position switch
6951	Minimum operation range of the second position switch
6952	Minimum operation range of the third position switch
6953	Minimum operation range of the fourth position switch
6954	Minimum operation range of the fifth position switch
6955	Minimum operation range of the sixth position switch
6956	Minimum operation range of the seventh position switch
6957	Minimum operation range of the eighth position switch
6958	Minimum operation range of the ninth position switch
6959	Minimum operation range of the tenth position switch

[Data type] 2-word

[Unit of data]

Increment system	IS-A	IS-B	IS-C	Unit
Metric input	0.01	0.001	0.0001	mm
Inch machine	0.001	0.0001	0.00001	inch
Rotation axis	0.01	0.001	0.0001	deg

[Valid data range] 0 to ± 99999999

These parameters set the minimum operation range of the first through tenth position switches.

4.36 PARAMETERS OF MANUAL OPERATION AND AUTOMATIC OPERATION

	#7	#6	#5	#4	#3	#2	#1	#0
7001	MFM							MIN

[Data type] Bit

MIN The manual intervention and return function is:

0 : Disabled.

1 : Enabled.

MFM For the manual linear or circular interpolation function, modifying a value specified with a command during jog feed in the guidance direction (approach direction):

0 : Immediately starts moving according to the new value.

1 : Stops moving.

	#7	#6	#5	#4	#3	#2	#1	#0
7050								RV1

Note

After setting this parameter, turn off the power. Then, turn the power back on to enable the setting.

[Data type] Bit

RV1 When the tool moves backwards after feed hold during forward feed with the retrace function:

0 : The block is split at the feed hold position and stored.

1 : The block is stored without being split.

Command block in program

-----*----->

If the tool moves backwards after feed hold at position indicated with *

When RV1 = 0

The block is split into two blocks and stored.

----->----->

When RV1 = 1

The block is stored as is.

----->

4.37 PARAMETERS OF MANUAL HANDLE FEED, HANDLE INTERRUPTION AND HANDLE FEED IN TOOL AXIAL DIRECTION

	#7	#6	#5	#4	#3	#2	#1	#0
7100				HPF	HCL		THD	JHD

[Data type] Bit

- JHD** Manual handle feed in JOG mode or incremental feed in the manual handle feed
0 : Invalid
1 : Valid
- THD** Manual pulse generator in TEACH IN JOG mode
0 : Invalid
1 : Valid
- HCL** The clearing of handle interruption amount display by soft key operation is:
0 : Disabled.
1 : Enabled.
- HPF** When a manual handle feed exceeding the rapid traverse rate is issued,
0 : The rate is clamped at the rapid traverse rate, and the handle pulses corresponding to the excess are ignored. (The graduations of the manual pulse generator may not agree with the distance the machine has traveled.)
1 : The rate is clamped at the rapid traverse rate, and the handle pulses corresponding to the excess are not ignored, but stored in the CNC. (If the rotation of the manual pulse generator is stopped, the machine moves by the distance corresponding to the pulses preserved in the CNC, then stops.)

	#7	#6	#5	#4	#3	#2	#1	#0
7101								IOL

[Data type] Bit

- IOL** Selects a manual pulse generator interface to be used during manual handle feed.
0 : Manual pulse generator interface on the main CPU board
1 : Manual pulse generator interface provided in the machine operator's panel interface for I/O-Link

	#7	#6	#5	#4	#3	#2	#1	#0
7102								HNGx

[Data type] Bit axis

HNGx Axis movement direction for rotation direction of manual pulse generator
 0 : Same in direction
 1 : Reverse in direction

	#7	#6	#5	#4	#3	#2	#1	#0
7104				3D2	3D1	CXC		TLX

[Data type] Bit

TLX When the tool axis direction handle feed function when tool axis direction handle feed is used, this parameter selects a tool axis direction when the rotation axes for the three basic axes in the basic coordinate system are positioned to the machine zero point:

0 : Z-axis direction
 1 : X-axis direction

CXC Tool axis direction handle feed is performed with:

0 : 5-axis machine.
 1 : 4-axis machine.

3D1 When handle feed is along (or across) the tool axis, the coordinate of the first rotation axis is:

0 : Machine coordinate that exists when tool axis direction handle feed (or radial tool axis handle feed) mode is selected, or when a reset occurs.
 1 : Value set in parameter No. 7144.

3D2 When handle feed is along (or across) the tool axis, the coordinate of the second rotation axis is:

0 : Machine coordinate that exists when tool axis direction handle feed (or radial tool axis handle feed) mode is selected, or when a reset occurs.
 1 : Value set in parameter No. 7145.

7110	Number of manual pulse generators used
------	----------------------------------------

[Data type] Byte

[Valid data range] 1, 2, or 3

This parameter sets the number of manual pulse generators.

7113	Manual handle feed magnification m
------	------------------------------------

[Data type] Word

[Unit of data] One time

[Valid data range] 1 to 127

This parameter sets the magnification when manual handle feed movement selection signal MP2 is on.

7114

Manual handle feed magnification n

[Data type] Word**[Unit of data]** One time**[Valid data range]** 1 to 1000

This parameter sets the magnification when manual handle feed movement selection signals MP1 and MP2 are “1”.

Movement selection signal		Movement (Manual handle feed)
MP2	MP1	
0	0	Least input increment × 1
0	1	Least input increment × 10
1	0	Least input increment × m
0	1	Least input increment × n

7120

Axis configuration for using the tool axis direction handle feed when tool axis direction handle feed function

[Data type] Byte**[Valid data range]** 1 to 4

When using the tool axis direction handle feed function, suppose that the rotation axes for the three basic axes X, Y, and Z in the basic coordinate system are axes A, B, and C, respectively. Suppose also that the Z-axis represents the tool axis direction when the rotation axes are positioned to the machine zero point. Then, depending on the axis configuration of the machine, four types are available. For a 4-axis machine, types (1) and (2) are available.

- (1) A–C axis type
- (2) B–C axis type
- (3) A–B axis (A–axis master) type
- (4) A–B axis (B–axis master) type

This parameter selects a type. Values of 1 to 4 are assigned to these types, in order, from top to bottom. When the X-axis represents the tool axis direction, the above types are changed to B–A axis type, C–A axis type, B–C axis (B–axis master) type, and B–C axis (C–axis master) type.

7121

Axis selection in tool axis direction handle feed mode

[Data type] Byte**[Valid data range]** 1 to number of controlled axes

This parameter sets an axis number for the manual handle feed axis selection signal for the first manual pulse generator to enable tool axis direction handle feed mode. When the value set in this parameter matches the value of the manual handle feed axis selection signal, tool axis direction handle feed mode is enabled.

7141	Axis selection in the X direction for the radial tool axis handle feed
7142	Axis selection in the Y direction for the radial tool axis handle feed

[Data type] Byte

[Valid data range] 1 to 8

These parameters specify the axis selection signal for the first manual pulse generator used to enable the radial tool axis handle feed. When the setting of these parameters matches the manual handle feed axis selection signal, radial tool axis handle feed mode is enabled.

7144	Coordinate of the first rotation axis for tool axis direction handle feed and radial tool axis handle feed
7145	Coordinate of the second rotation axis for tool axis handle feed and radial tool axis handle feed

[Data type] 2-word

[Unit of data] 0.001 degrees

[Valid data range] -360000 to 360000

These parameters specify the coordinates (rotation degrees) of the first and second rotation axes used when parameters 3D1 and 3D2 (bits 3 and 4 of parameter No. 7104) are 1. When parameter CXC (bit 2 of parameter No. 7104) is 1, however, the coordinate of the second rotation axis is assumed to be 0 regardless of the value of 3D2 or this parameter.

4.38 PARAMETERS RELATED TO BUTT-TYPE REFERENCE POSITION SETTING

7181

First withdrawal distance in butt-type reference position setting

[Data type] 2-word axis**[Unit of data]**

Increment system	IS-A	IS-B	IS-C	Unit
Millimeter machine	0.01	0.001	0.0001	mm
Inch machine	0.001	0.0001	0.00001	inch

[Valid data range] -99999999 to 99999999

When the butt-type reference position setting function is used, this parameter sets a distance an axis, along which withdrawal is performed after the mechanical stopper is hit (distance from the mechanical stopper to the withdrawal point).

7182

Second withdrawal distance in butt-type reference position setting

[Data type] 2-word axis**[Unit of data]**

Increment system	IS-A	IS-B	IS-C	Unit
Millimeter machine	0.01	0.001	0.0001	mm
Inch machine	0.001	0.0001	0.00001	inch

[Valid data range] -99999999 to 99999999

When the butt-type reference position setting function is used, this parameter sets a distance an axis, along which withdrawal is performed after the mechanical stopper is hit (distance from the mechanical stopper to the withdrawal point).

7183

First butting feedrate in butt-type reference position setting

[Data type] Word axis**[Unit of data and valid range]**

Increment system	Unit of data	Valid data range	
		IS-A, IS-B	IS-C
Millimeter machine	1 mm/min	30-15000	30-12000
Inch machine	0.1 inch/min	30-6000	30-4800

When the butt-type reference position setting function is used, this parameter sets the feedrate first used to hit the stopper on an axis.

7184

Second butting feedrate in butt-type reference position setting

[Data type] Word axis**[Unit of data and valid range]**

Increment system	Unit of data	Valid data range	
		IS-A, IS-B	IS-C
Millimeter machine	1 mm/min	30–15000	30–12000
Inch machine	0.1 inch/min	30–6000	30–4800

When the butt-type reference position setting function is used, this parameter sets the feedrate used to hit the stopper on an axis for a second time.

7185

Withdrawal feedrate (common to the first and second butting operations) in butt-type reference position setting

[Data type] Word axis**[Unit of data and valid range]**

Increment system	Unit of data	Valid data range	
		IS-A, IS-B	IS-C
Millimeter machine	1 mm/min	30–15000	30–12000
Inch machine	0.1 inch/min	30–6000	30–4800

When the butt-type reference position setting function is used, this parameter sets the feedrate used for withdrawal along an axis after the mechanical stopper has been hit.

7186

Torque limit value in butt-type reference position setting

[Data type] Byte axes**[Unit of data]** %**[Valid data range]** 0 to 100

This parameter sets a torque limit value in butt-type reference position setting.

Note

When 0 is set in this parameter, 100% is assumed.

4.39 PARAMETERS OF SOFTWARE OPERATOR'S PANEL

	#7	#6	#5	#4	#3	#2	#1	#0
7200		OP7	OP6	OP5	OP4	OP3	OP2	OP1

[Data type] Bit





- OP1** Mode selection on software operator's panel
0 : Not performed
1 : Performed
- OP2** JOG feed axis select and JOG rapid traverse buttons on software operator's panel
0 : Not performed
1 : Performed
- OP3** Manual pulse generator's axis select and manual pulse generator's magnification switches on software operator's panel
0 : Not performed
1 : Performed
- OP4** JOG speed override and rapid traverse override switches on software operator's panel
0 : Not performed
1 : Performed
- OP5** Optional block skip, single block, machine lock, and dry run switches on software operator's panel
0 : Not performed
1 : Performed
- OP6** Protect key on software operator's panel
0 : Not performed
1 : Performed
- OP7** Feed hold on software operator's panel
0 : Not performed
1 : Performed

7210	Job-movement axis and its direction on software operator's panel [↑]
7211	Job-movement axis and its direction on software operator's panel [↓]
7212	Job-movement axis and its direction on software operator's panel [→]
7213	Job-movement axis and its direction on software operator's panel [←]
7214	Job-movement axis and its direction on software operator's panel [↘]
7215	Job-movement axis and its direction on software operator's panel [↙]
7216	Job-movement axis and its direction on software operator's panel [↗]
7217	Job-movement axis and its direction on software operator's panel [↖]

[Data type] Byte

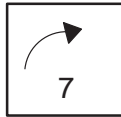
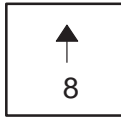
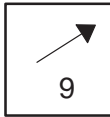
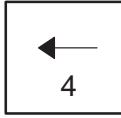
[Valid data range] 0 to 8

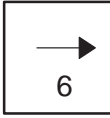
On software operator's panel, set a feed axis corresponding to an arrow key on the CRT/MDI panel when jog feed is performed.

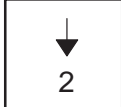
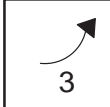
Set value	Feed axis and direction	Arrow keys on the CRT/MDI panel		
0	Not moved			
1	First axis, positive direction			
2	First axis, negative direction			
3	Second axis, positive direction			
4	Second axis, negative direction			
5	Third axis, positive direction			
6	Third axis, negative direction			
7	Fourth axis, positive direction			
8	Fourth axis, negative direction			

Example

Under X, Y, and Z axis configuration, to set arrow keys to feed the axes in the direction specified as follows, set the parameters to the values given below. [8 ↑] to the positive direction of the Z axis, [2 ↓] to the negative direction of the Z axis, [6 →] to the positive direction of the X axis [4 ←] to the negative direction of the X axis, [1 ↙] to the positive direction of the Y axis, [9 ↗] to the negative direction of the Y axis

- Parameter No. 7210 = 5 (Z axis, positive direction)
- Parameter No. 7211 = 6 (Z axis, negative direction)
- Parameter No. 7212 = 1 (X axis, positive direction)
- Parameter No. 7213 = 2 (X axis, negative direction)
- Parameter No. 7214 = 3 (Y axis, positive direction)
- Parameter No. 7215 = 4 (Y axis, negative direction)
- Parameter No. 7216 = 0 (Not used)
- Parameter No. 7217 = 0 (Not used)

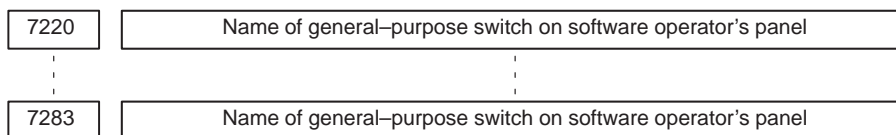

[Data type] Byte

Example

These parameters set the names of the general-purpose switches (SIGNAL 1 through SIGNAL 8) on the software operator's panel as described below.

OPERATOR'S PANEL O1234 N5678

SIGNAL 1 :	<input type="checkbox"/> OFF	<input type="checkbox"/> ON
SIGNAL 2 :	<input type="checkbox"/> OFF	<input checked="" type="checkbox"/> ON
SIGNAL 3 :	<input type="checkbox"/> OFF	<input checked="" type="checkbox"/> ON
SIGNAL 4 :	<input checked="" type="checkbox"/> OFF	<input type="checkbox"/> ON
SIGNAL 5 :	<input checked="" type="checkbox"/> OFF	<input type="checkbox"/> ON
SIGNAL 6 :	<input checked="" type="checkbox"/> OFF	<input type="checkbox"/> ON
SIGNAL 7 :	<input checked="" type="checkbox"/> OFF	<input type="checkbox"/> ON
SIGNAL 8 :	<input type="checkbox"/> OFF	<input checked="" type="checkbox"/> ON

These names are set using character codes that are displayed in parameter Nos. 7220 to 7283.

Parameter No. 7220:

Sets the character code (083) corresponding to S of SIGNAL 1.

Parameter No. 7221:

Sets the character code (073) corresponding to I of SIGNAL 1.

Parameter No. 7222:

Sets the character code (071) corresponding to G of SIGNAL 1.

Parameter No. 7223:

Sets the character code (078) corresponding to N of SIGNAL 1.

Parameter No. 7224:

Sets the character code (065) corresponding to A of SIGNAL 1.

Parameter No. 7225:

Sets the character code (076) corresponding to L of SIGNAL 1.

Parameter No. 7226:

Sets the character code (032) corresponding to (space) of SIGNAL 1.

Parameter No. 7227:

Sets the character code (049) corresponding to 1 of SIGNAL 1.

Parameter Nos. 7228 to 7235:

Set the character codes of SIGNAL 2 shown in the figure above.

Parameter Nos. 7236 to 7243:

Set the character codes of SIGNAL 3 shown in the figure above.

Parameter Nos. 7244 to 7251:

Set the character codes of SIGNAL 4 shown in the figure above.

Parameter Nos. 7252 to 7259:

Set the character codes of SIGNAL 5 shown in the figure above.

Parameter Nos. 7260 to 7267:

Set the character codes of SIGNAL 6 shown in the figure above.

Parameter Nos. 7268 to 7275:

Set the character codes of SIGNAL 7 shown in the figure above.

Parameter Nos. 7276 to 7283:

Set the character codes of SIGNAL 8 shown in the figure above.

The character codes are shown in Appendix 1 CHARACTER CODE LIST.

4.40 PARAMETERS OF PROGRAM RESTART

7310

Movement sequence to program restart position

Setting entry is accepted.

[Data type] Byte

[Valid data range] 1 to no. of controlled axes

This parameter sets the axis sequence when the machine moves to the restart point by dry run after a program is restarted.

[Example]

The machine moves to the restart point in the order of the fourth, first, second, and third axes one at a time when the first axis = 2, the second axis = 3, the third axis = 4, and the fourth axis = 1 are set.

7351

Macro variable start number

[Data type] Word

[Valid data range] 500 to 975

This parameter specifies the first variable number where data for the machining return or restart function is stored. If a value out of the valid data range is specified, 500 is assumed.

Note

- 1 If 0 is specified, the machining return or restart data will not be set in a macro variable.
- 2 If a value from 507 to 531 is specified, 500 is assumed. If 532 or greater is specified, the custom macro variable expansion option becomes necessary.

4.41 PARAMETERS OF HIGH-SPEED MACHINING (HIGH-SPEED CYCLE MACHINING/HIGH- SPEED REMOTE BUFFER)

	#7	#6	#5	#4	#3	#2	#1	#0
7501	IPC	IT2	IT1	IT0				CSP
	IPC	IT2	IT1	IT0				

[Data type] Bit

CSP Cs contouring control function dedicated to a piston lathe is
 0 : Not used.
 1 : Used.

IT0, IT1, IT2

IT2	IT1	IT0	Interpolation of G05 data (ms)
0	0	0	8
0	0	1	2
0	1	0	4
0	1	1	1
1	0	0	16

IPC

0 : The system does not monitor whether a distribution process is stopped while high-speed machining (G05) is performed with high-speed remote buffer A or B or in a high-speed cycle.
 1 : The system monitors whether a distribution process is stopped while high-speed machining (G05) is performed with high-speed remote buffer A or B or in a high-speed cycle.
 (Alarms 179 and 000 are simultaneously issued if the distribution process is stopped. In this case, the power must be turned off then on again.)

Note

The distribution process stops, when the host cannot send data with the high-speed remotebuffer by the specified time.

	#7	#6	#5	#4	#3	#2	#1	#0
7502					L8M		PMX	
					L8M		PMX	SUP

[Data type] Bit axis

SUP In high-speed remote buffering and high-speed machining:
 0 : Acceleration/deceleration control is not applied.
 1 : Acceleration/deceleration control is applied.

PMX A PMC axis control command in high-speed cycle machining (G05) is:
 0 : Ignored.
 1 : Executed.

L8M In high-speed cycle machining (G05) with an interpolation period of 8 msec, digital servo learning control is:
 0 : Not applied.
 1 : Applied.

	#7	#6	#5	#4	#3	#2	#1	#0
7505							HUNx	HSCx
								HSCx

Note

After setting this parameter, the power must be tuned off then on again.

[Data type] Bit axis

HSCx Specifies whether each axis is used for high-speed distribution in a high-speed cycle or with a high-speed remote buffer.
 0 : Not used for high-speed distribution.
 1 : Used for high-speed distribution

HUNx Specifies whether the unit of data to be distributed during machining a high-speed cycle is tentimes the least input increment.
 0 : The unit of data is the same as the least input increment.
 1 : The unit of data is ten times the least input increment.

Note

This parameter is used when a data item to be distributed exceeds a word in terms of the least input increment or the maximum travel speed.
 The data to be distributed for machining in a high-speed cycle for the axes in which this parameter HUNX = 1 is set.
 Therefore, set a value one tenth the value to be distributed for machining in a high-speed cycle along the specified axes.

7510

Maximum number of simultaneously controlled axes when G05 is specified during high-speed cycle machining/no. of controlled axes in high-speed remote buffer

[Data type] Word**[Valid data range]** 1 to 16

This parameter sets the maximum number of simultaneous control axes when G05 is specified during high-speed cycle machining or sets the number of control axes in a high-speed remote buffer.

7511

Extension of data variables used for machining in a high-speed cycle

Note

When this parameter is set, the power must be turned off before operation is continued.

[Data type] Byte**[Valid data range]** 0 to 8

This parameter sets the size for extending the data variables used for machining in a high-speed cycle. (Variables 200000 to 462143)

Set value	Means
0	Variable #200000 is not used. Conventional variables #200000 to #85535 are used.
1	Variables #200000 to #232767 are used.
2	Variables #200000 to #265535 are used.
3	Variables #200000 to #298303 are used.
4	Variables #200000 to #331072 are used.
5	Variables #200000 to #363839 are used.
6	Variables #200000 to #396607 are used.
7	Variables #200000 to #429375 are used.
8	Variables #200000 to #462143 are used.

4.42 PARAMETERS OF POLYGON TURNING

	#7	#6	#5	#4	#3	#2	#1	#0
7600	PLZ							

[Data type] Bit

PLZ Synchronous axis using G28 command

0: Returns to the reference position in the same sequence as the manual reference position return.

1: Returns to the reference position by positioning at a rapid traverse. The synchronous axis returns to the reference position in the same sequence as the manual reference position return when no return-to-reference position is performed after the power is turned on.

	#7	#6	#5	#4	#3	#2	#1	#0
7602			COF	HST	HSL	HDR	SNG	MNG

[Data type] Bit

MNG The rotational direction of the master axis (first spindle) in the spindle–spindle polygon turning mode is:

0 : Not reversed.

1 : Reversed.

SNG The rotational direction of the polygon synchronization axis (second spindle) in the spindle–spindle polygon turning mode is:

0 : Not reversed.

1 : Reversed.

HDR When phase control is exercised in spindle–spindle polygon turning mode (COF = 0), the phase shift direction is:

0 : Not reversed for phase synchronization.

1 : Reversed for phase synchronization.

Note

Use MNG, SNG, and HDR when the specified rotational direction of the master axis or polygon synchronization axis, or the specified phase shift direction is to be reversed in spindle–spindle polygon turning mode.

HSL When phase control is exercised in spindle–spindle polygon turning mode (COF = 0), this parameter selects the spindle that is subject to a phase shift operation for phase synchronization:

0 : The polygon synchronization axis (second spindle) is selected.

1 : The master axis (first spindle) is selected.

- HST** When phase control is applied in spindle–spindle polygon turning mode (COF = 0), and spindle–spindle polygon turning mode is specified:
- 0 : Spindle–spindle polygon turning mode is entered with the current spindle speed maintained.
 - 1 : Spindle–spindle polygon turning mode is entered after the spindle is stopped.

Note

This parameter can be used, for example, when single–rotation signal detection cannot be guaranteed at an arbitrary feedrate because a separate detector is installed to detect the spindle single–rotation signal, as when a built–in spindle is used. (When bit 7 of parameter No. 4016 for the serial spindle is set to 1, together with this parameter, a single–rotation signal detection position in spindle–spindle polygon turning mode is guaranteed.)

- COF** In spindle–spindle polygon turning mode, phase control is:
- 0 : Used.
 - 1 : Not used.

Note

When the use of phase control is not selected, the steady state is reached in a shorter time because phase synchronization control is not applied. Once steady rotation is achieved, however, polygonal turning must be completed without changing the steady state. (If the rotation is stopped, or the rotational speed altered, polygonal turning is disabled because of the inevitable phase shift.) Even when this parameter is set to 1, an R command (phase position command) in a block containing G51.2 is ignored ; no alarm is issued.

	#7	#6	#5	#4	#3	#2	#1	#0
7603	PST		RDG				QDR	RPL

[Data type] Bit

- RPL** Upon reset, spindle–spindle polygon turning mode is:
- 0 : Released.
 - 1 : Not released.
- QDR** The rotational direction of the polygon synchronization axis:
- 0 : Depends on the sign (+/–) of a specified value for Q.
 - 1 : Depends on the rotational direction of the first spindle. (If – is specified for Q, P/S alarm No. 218 is issued.)
- RDG** On the diagnosis screen No. 476, for spindle–spindle polygon phase command value (R), displays:
- 0 : The specified value (in the increment system for the rotation axis).
 - 1 : The actual number of shift pulses.

Note

A phase command is specified in address R, in units of degrees. For control, the actual shift amount is converted to a number of pulses according to the conversion formula: 360 degrees = 4096 pulses. This parameter switches the display of a specified value to that of a converted value.

PST The polygon spindle stop signal *PLSST (bit 0 of G038) is:
 0 : Not used.
 1 : Used.

7610	Control axis number of tool rotation axis for polygon turning
------	---------------------------------------------------------------

[Data type] Byte

[Valid data range] 1, 2, 3, . . . number of control axes

This parameter sets the control axis number of a rotation tool axis used for polygon turning.

7620	Movement of tool rotation axis per revolution
------	-----------------------------------------------

[Data type] 2-word

Increment system	IS-A	IS-B	IS-C	Unit
Rotation axis	0.01	0.001	0.0001	deg

[Valid data range] 1 to 9999999

This parameter sets the movement of a tool rotation axis per revolution.

7621	Maximum allowable speed for the tool rotation axis (polygon synchronization axis)
------	-----------------------------------------------------------------------------------

[Data type] Word

[Unit of data] rpm

[Valid data range] For polygonal turning using servo motors:

$$0 \text{ to } 1.2 \times 10^8$$

set value of the parameter No. 7620

For polygon turning with two spindles:

Set a value between 0 and 32767, but which does not exceed the maximum allowable speed, as determined by the performance of the second spindle and other mechanical factors.

This parameter sets the maximum allowable speed of the tool rotation axis (polygon synchronization axis).

If the speed of the tool rotation axis (polygon synchronization axis) exceeds the specified maximum allowable speed during polygon turning, the speed is clamped at the maximum allowable speed. When the speed is clamped at a maximum allowable speed, however, synchronization between the spindle and tool rotation axis (polygon synchronization axis) is lost. And, when the speed is clamped, P/S alarm No. 5018 is issued.

7631	Allowable spindle speed deviation level in spindle–spindle polygon turning
------	----------------------------------------------------------------------------

[Data type] Byte

[Unit of data] rpm

[Valid data range] 0 to 255

[Standard setting value] 1 to 10

This parameter sets the allowable level of deviation between the actual speed and specified speed of each spindle in spindle–spindle polygon turning. The value set with this parameter is used for both the master axis and polygon synchronization axis.

7632	Steady state confirmation time duration in spindle polygon turning
------	--------------------------------------------------------------------

[Data type] Word

[Unit of data] ms

[Valid data range] 0 to 32767

This parameter sets the duration required to confirm that both spindles have reached their specified speeds in spindle–spindle polygon turning. If the state where the speed of each spindle is within the range set with parameter No. 7631, and has lasted at least for the duration specified with parameter No. 7632, the spindle polygon speed arrival signal PSAR (bit 2 of F0063) is set to 1.

4.43 PARAMETERS OF THE EXTERNAL PULSE INPUT

7681	
	Setting 1 for the ratio of an axis shift amount to external pulses (M)

[Data type] Word

[Valid data range] 1 to 255

7682	
	Setting 2 for the ratio of an axis shift amount to external pulses (N)

[Data type] Word

[Valid data range] 1 to 1000

4.44 PARAMETERS OF THE HOBBING MACHINE AND ELECTRONIC GEAR BOX

	#7	#6	#5	#4	#3	#2	#1	#0
7700								
		DPS	RTO		MLT	HDR	CMS	HBR

[Data type] Bit

- HBR** 0 : Performing a reset does not cancel synchronization of the C-axis to the hob axis (G81).
1 : Performing a reset cancels synchronization of the C-axis to the hob axis (G81).
- CMS** 0 : The position manually set with a single rotation signal is canceled when a synchronization cancel command (G80, reset) is issued.
1 : The position manually set with a single rotation signal is not canceled when a synchronization cancel command (G80, reset) is issued.
- HDR** Setting of the direction for compensating a helical gear (1 is usually specified.)
- MLT** Unit of data for the magnification for compensating C-axis servo delay (parameter 7714)
0 : 0.001
1 : 0.0001
- RTO** Gear ratio for the spindle and position coder specified in parameter 3706
0 : Disabled (Always specify 0.)
1 : Enabled
- DPS** Display of actual spindle speed
0 : The hob-axis speed is displayed.
1 : The spindle speed is displayed.

	#7	#6	#5	#4	#3	#2	#1	#0
7701								
			DLY	JHD		SM3	SM2	SM1

[Data type] Bit

SM1, SM2, and SM3 Specify the number of times a feedback pulse from the position coder is sampled when the hobbing machine function is used.

SM3	SM2	SM1	Number of times the pulse is sampled
0	0	0	4
0	0	1	1
0	1	0	2
0	1	1	16
1	0	0	32
1	1	0	4
1	1	1	4

JHD While the C-axis and hob axis are synchronized with each other (in the G81 mode), jogging and handle feeds around the C-axis are
 0 : Disabled
 1 : Enabled

DLY Compensating C-axis servo delay with G84 is
 0 : Disabled
 1 : Enabled

7709	Number of the axial feed axis for a helical gear
------	--------------------------------------------------

[Data type] Byte

[Valid range] 1 to the maximum number of controlled axes

This parameter sets the number of the axial feed axis for a helical gear. If the value out of the valid range is specified, 3 (the 3rd axis) is specified.

Note

After setting this parameter, the power must be turned off then on again.

7710	Number of the axis synchronized with the hob axis
------	---------------------------------------------------

Note

When this parameter is set, the power must be turned off before operation is continued.

[Data type] Byte

[Valid range] 1 to the maximum number of controlled axes

This parameter sets the number of the axis (workpiece) that is synchronized with the hob axis (cutter). If a value out of the valid range is specified, 4 (the 4th axis) is assumed.

7711	Gear ratio for the hob axis and position coder
------	------------------------------------------------

[Data type] Byte

[Valid range] 1 to 20

[Unit of data] 1 time

This parameter sets the gear ratio for the hob axis and position coder.

7712	
	Time constant for C-axis acceleration/deceleration during rotation with the hob axis and C-axis synchronized with each other

[Data type] Word

[Unit of data] ms

[Valid range] 0 to 4000

This parameter sets the time constant for C-axis exponential acceleration/deceleration during rotation with the hob axis and C-axis synchronized with each other.

Note

Acceleration/deceleration is applied to G01, G83, or compensation of a helical gear with the time constant and FL speed for acceleration/deceleration during cutting feed (parameters 1622 and 1623).

7713	
	FL speed of C-axis acceleration/deceleration during rotation with the hob axis and C-axis synchronized each other

[Data type] Word

[Unit of data and valid range]

Unit of data	Valid range	
	IS-B	IS-C
1 deg/min	6 to 15000	6 to 12000

This parameter sets the FL speed of C-axis exponential acceleration/deceleration during rotation with the hob axis and C-axis synchronized with each other.

7714	
	Magnification 2 for compensation of C-axis servo delay by G83

[Data type] Word

[Unit of data] 0.0001/0.001

[Valid range] 500 to 2000

This parameter sets the magnification for compensation of C-axis servo delay by G83.

7715	
	Magnification 1 for compensation of C-axis servo delay by G83

[Data type] Word

[Unit of data] 0.0001/0.001

[Valid range] 500 to 2000

This parameter sets the magnification for compensation of C-axis servo delay by G83.

7730	#7	#6	#5	#4	#3	#2	#1	#0
								RTRx

[Data type] Bit axis

RTRx Specifies whether the retraction function is effective for each axis.

0 : Retraction is disabled.

1 : Retraction is enabled.

7740	
	Feedrate during retraction for each axis

[Data type] 2-word axis

[Unit of data and valid range]

Increment system	Unit of data	Valid range	
		IS-B	IS-C
Millimeter machine	1 mm/min	30 to 240000	30 to 100000
Inch machine	0.1 inch/min	30 to 96000	30 to 48000

This parameter sets the feedrate during retraction for each axis.

7741	
	Retracted distance for each axis

[Data type] 2-word axis

[Valid range] ± 99999999

Unit of data	Valid range	
	IS-B	IS-C
Millimeter input	0.001 mm	0.0001 mm
Inch input	0.0001 inch	0.00001 inch

This parameter sets the retracted distance for each axis.

7771	
	Number of EGB axis

Notes

After setting this parameter, turn off the power. Then, turn the power back on to enable the setting.

[Data type] Byte

[Valid data range] 1 to the number of controlled axes

This parameter specifies the number of the EGB axis.

Notes

- 1 You cannot specify four because the fourth axis is used as the workpiece axis.
- 2 For a machine using the inch increment system, linear axes cannot be used as the EGB axis.

7772	
	Number of position detector pulses per rotation about tool axis

[Data type] 2-word

[Data unit] Detection unit

[Valid data range] 1 to 99999999

This parameter specifies the number of pulses per rotation about the tool axis (on the spindle side), for the position detector.

Note

Specify the number of feedback pulses per rotation about the tool axis for the position detector, considering the gear ratio with respect to the position coder.

7773	
	Number of position detector pulses per rotation about workpiece axis

[Data type] 2-word

[Data unit] Detection unit

[Valid data range] 1 to 99999999

This parameter specifies the number of pulses per rotation about the workpiece axis (on the fourth axis side), for the position detector.

[Example]

The number of feedback pulses for the position detector is 360000 for a rotation axis for which the detection unit is 0.001 deg.

4.45 PARAMETERS OF AXIS CONTROL BY PMC

	#7	#6	#5	#4	#3	#2	#1	#0
8001	SKE	AUX	NCC		RDE	OVE		MLE

[Data type] Bit

MLE Whether all axis machine lock signal MLK is valid for PMC-controlled axes

0 : Valid

1 : Invalid

Note

Each-axis machine lock signals MLK1 to MLK8 are always valid, regardless of the setting of this parameter.

OVE Signals related to dry run and override used in PMC axis control

0: Same signals as those used for the CNC

(1) Feedrate override signals *FV0 to *FV7

(2) Override cancellation signal OVC

(3) Rapid traverse override signals ROV1 and ROV2

(4) Dry run signal DRN

(5) Rapid traverse selection signal RT

1: Signals specific to the PMC

(1) Feedrate override signals *FV0E to *FV7E

(2) Override cancellation signal OVCE

(3) Rapid traverse override signals ROV1E and ROV2E

(4) Dry run signal DRNE

(5) Rapid traverse selection signal RTE

RDE Whether dry run is valid for rapid traverse in PMC axis control

0 : Invalid

1 : Valid

NCC When a travel command is issued for a PMC-controlled axis (selected by a controlled-axis selection signal) according to the program:

0 : P/S alarm 139 is issued while the PMC controls the axis with an axis control command. While the PMC does not control the axis, a CNC command is enabled.

1 : P/S alarm 139 is issued unconditionally.

AUX The number of bytes for the code of an auxiliary function (12H) command to be output is

0 : 1 (0 to 255)

1 : 2 (0 to 65535)

SKE Skip signal during axis control by the PMC

0 : Uses the same signal SKIP (X004#7) as CNC.

1 : Uses dedicated axis control signal ESKIP (X004#6) used by the PMC.

	#7	#6	#5	#4	#3	#2	#1	#0
8002	FR2	FR1	PF2	PF1	F10	SUE	DWE	RPD

[Data type] Bit

- RPD** Rapid traverse rate for PMC-controlled axes
 0 : Feedrate specified with parameter No. 1420
 1 : Feedrate specified with the feedrate data in an axis control command
- DWE** Minimum time which can be specified in a dwell command in PMC axis control when the increment system is IS-C
 0 : 1 ms
 1 : 0.1 ms
- SUE** Whether acceleration/deceleration is performed for an axis that is synchronized with external pulses, for external pulse synchronization commands in PMC axis control
 0 : Performed (exponential acceleration/deceleration)
 1 : Not performed
- F10** Least increment for the feedrate for cutting feed (per minute) in PMC axis control

F10	Metric input	Inch input
0	1 mm/min	0.01 inch/min
1	10 mm/min	0.1 inch/min

PF1, PF2 Set the the feedrate unit of feed per minute in PMC axis control

PF2	PF1	Feedrate unit
0	0	1/1
0	1	1/10
1	0	1/100
1	1	1/1000

FR1, FR2 Set the feedrate unit for feed per rotation for an axis controlled by the PMC.

FR2	FR1	Metric input	Inch input
0	0	0.0001 mm/rev	0.000001 inch/rev
1	1		
0	1	0.001 mm/rev	0.00001 inch/rev
1	0	0.01 mm/rev	0.0001 inch/rev

	#7	#6	#5	#4	#3	#2	#1	#0
8003								PIM

Note

When this parameter is set, the power must be turned off before operation is continued.

[Data type] Bit

PIM When only the axes controlled by the PMC are used, the linear axis is:

- 0: Influenced by inch/millimeter input.
 1: Not influenced by inch/millimeter input.

	#7	#6	#5	#4	#3	#2	#1	#0
8004	NDI	NCI	DSL	G8R	G8C	JFM	NMT	
		NCI	DSL	G8R	G8C	JFM	NMT	

- NMT** When a command is specified from the CNC for the axis on which the tool is moving according to axis control specification from the PMC:
 0 : P/S alarm No. 130 is issued.
 1 : The command is executed without issuing an alarm, provided the command does not involve a movement on the axis.

- JFM** This parameter sets the units used to specify feedrate data when continuous feed is specified in axis control by the PMC.

Increment system	JFM	Input in mm	Input in inches	Rotation axis
IS-B	0	1 mm/min	0.01 inch/min	0.00023 rpm
	1	200 mm/min	2.00 inch/min	0.046 rpm
IS-C	0	0.1 mm/min	0.001 inch/min	0.000023 rpm
	1	20 mm/min	0.200 inch/min	0.0046 rpm

- G8C** Look-ahead control for the axes controlled by the PMC is:
 0 : Disabled.
 1 : Enabled.

Note

This parameter is valid for an axis for which bit 7 (NAHx) of parameter No. 1819 is set to 0.

- G8R** Look-ahead control over axes controlled by the PMC is:
 0 : Enabled for cutting feed (disabled for rapid traverse).
 1 : Enabled for both cutting feed and rapid traverse.

Note

This parameter is valid for an axis for which bit 7 (NAHx) of parameter No. 1819 is set to 0.

- DSL** If the selection of an axis is changed when PMC axis selection is disabled:
 0 : P/S alarm No. 139 is issued.
 1 : The change is valid, and no alarm is issued for an unspecified system.
- NCI** In axis control by the PMC, a position check at the time of deceleration is:
 0 : Performed.
 1 : Not performed.
- NDI** During PMC axis control, when a diameter is specified for PMC controlled axes:
 0 : The amount of travel specified in the command is multiplied by two but the speed specified in the command is used as is.
 1 : The amount of travel specified in the command is used as is but the speed specified in the command is multiplied by 1/2.

Notes

This parameter is valid when bit 3 (DIA) of parameter No. 1006 is set to 1.

[Example]

The table below lists the values for PMC axis control and memory operation when a rapid traverse command specifies an amount of travel of 100.000 mm and a speed of 100 mm/min.

	When specified with a PMC signal		When specified with a memory operation
	NDI=0	NDI=1	
Speed	100 mm/min	50 mm/min	100 mm/min
Amount of travel	200.00 mm	100.000 mm	100.000 mm
Travel time	60 sec	60 sec	30 sec

	#7	#6	#5	#4	#3	#2	#1	#0
8005						CDI		

[Data type] Bit

CDI During PMC axis control, when a diameter is specified for a PMC controlled axes:

0 : The amount of travel specified in the command is multiplied by two but the speed specified in the command is used as is.

1 : The amount of travel and speed specified in the command are used as is.

Notes

1 This parameter is valid when bit 3 (DIA) of parameter No. 1006 is set to 1.

2 When CDI is set to 1, bit 7 (NDI) of parameter No. 8004 is disabled.

[Example]

The table below lists the values for PMC axis control and memory operation when a rapid traverse command specifies an amount of travel of 100.000 mm and a speed of 100 mm/min.

	When specified with a PMC signal		When specified with a memory operation
	CDI=0	CDI=1	
Speed	100 mm/min	100 mm/min	100 mm/min
Amount of travel	200.00 mm	100.000 mm	100.000 mm
Travel time	60 sec	30 sec	30 sec

8010

Selection of the DI/DO group for each axis controlled by the PMC

[Data type] Byte axis**[Valid data range]** 1 to 4

Specify the DI/DO group to be used to specify a command for each PMC-controlled axis.

Value	Description
1	DI/DO group A (G142 to G153) is used.
2	DI/DO group B (G154 to G165) is used.
3	DI/DO group C (G166 to G177) is used.
4	DI/DO group D (G178 to G189) is used.

Note

If another value is specified, the axis is not PMC-controlled.

8022

Upper-limit rate of feed per revolution during PMC axis control

[Data type] Word**[Unit of data]****[Valid data range]**

Increment system	Unit data	Valid data range	
		IS-B	IS-C
Millimeter machine	1 mm/min	6-15000	6-12000
Inch machine	0.1 inch/min	6-6000	6-4800
Rotation axis	1 deg/min	6-15000	6-12000

This parameter sets the upper limit rate of feed per revolution during PMC axis control.

4.46 PARAMETERS OF TWO-PATH CONTROL

	#7	#6	#5	#4	#3	#2	#1	#0
8100		DSB	COF				IAL	RST
	NWP							RST

[Data type] Bit

- RST** Reset key on the CRT/MDI panel
 0 : Effective for both paths, or in the M series, for both machining and background drawing sides
 1 : Effective for a path selected by the path selection signal, or in the M series, for the background drawing side.
- IAL** When an alarm is raised in one tool post in the automatic operation mode,
 0 : The other path enters the feed hold state and stops.
 1 : The other path continues operation without stopping.
- COF** Tool post 1 and tool post 2 (under two-path control) use:
 0 : Their own tool compensation memories.
 1 : Common tool compensation memory.
- DSB** The special single block function (under two-path control) is:
 0 : Disabled.
 1 : Enabled.

8110	Waiting M code range (minimum value)
------	--------------------------------------

[Data type] 2-word

[Valid data range] 0 and 100 to 99999999

This parameter specifies the minimum value of the waiting M code.

The waiting M code range is specified using parameter 8110 (minimum value) and parameter 8111 (maximum value).

(parameter 8110) ≤ (waiting M code) ≤ (parameter 8111)

Notes

A value of 0 indicates that the waiting M code is not used.

8111	Waiting M code range (maximum value)
------	--------------------------------------

[Data type] 2-word

[Valid data range] 0 and 100 to 99999999

This parameter specifies the maximum value of the waiting M code.

4.47 PARAMETERS FOR CHECKING INTERFERENCE BETWEEN TOOL POSTS (TWO-PATH CONTROL)

	#7	#6	#5	#4	#3	#2	#1	#0
8140			ZCL	IFE	IFM	ITO	TY1	TY0

[Data type] Bit

TY0, TY1 This parameter specifies the relationship between the coordinate systems of the two tool paths.

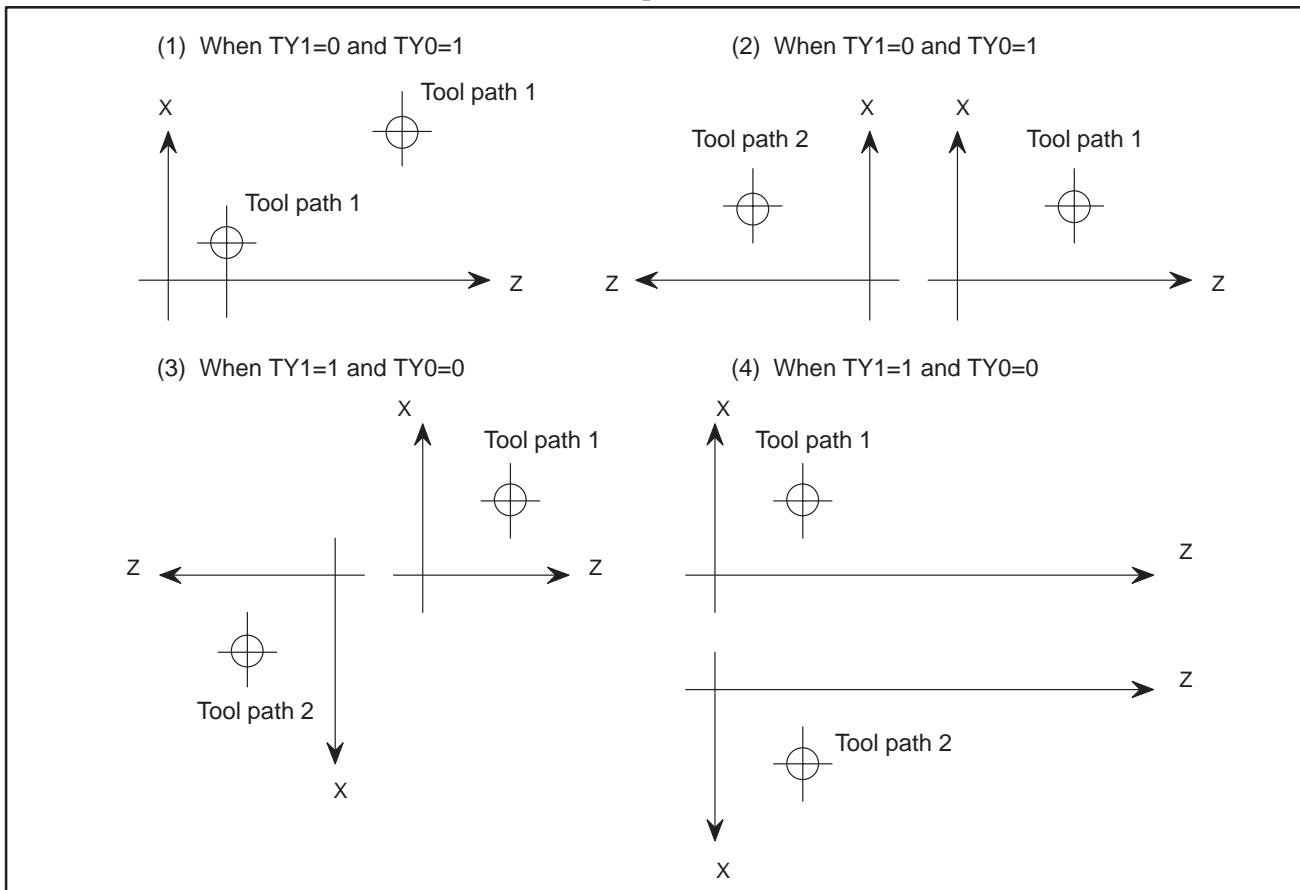

ITO When offset number 0 is specified by the T code,
 0 : Checking interference between tool posts is stopped until an offset number other than 0 is specified by the next T code.
 1 : Checking interference between tool posts is continued according to the previously specified offset number.

IFM Specifies whether interference between tool posts is checked in the manual operation mode.
 0 : Not checked
 1 : Checked

IFE Specifies whether interference between tool posts is checked.
 0 : Checked
 1 : Not checked

ZCL Specifies whether interference along the Z axis is checked while checking interference between tool posts.
 0 : Checked
 1 : Not checked (Only interference along the X axis is checked.)

8151 Distance along the X axis between the reference positions of tool posts 1 and 2

8152 Distance along the Z axis between the reference positions of tool posts 1 and 2

[Data type] 2-word

[Unit of data]

Increment system	IS-B	IS-C	Unit
Metric input	0.001	0.0001	mm
Inch machine	0.0001	0.00001	inch

[Valid data range] 0 to 99999999

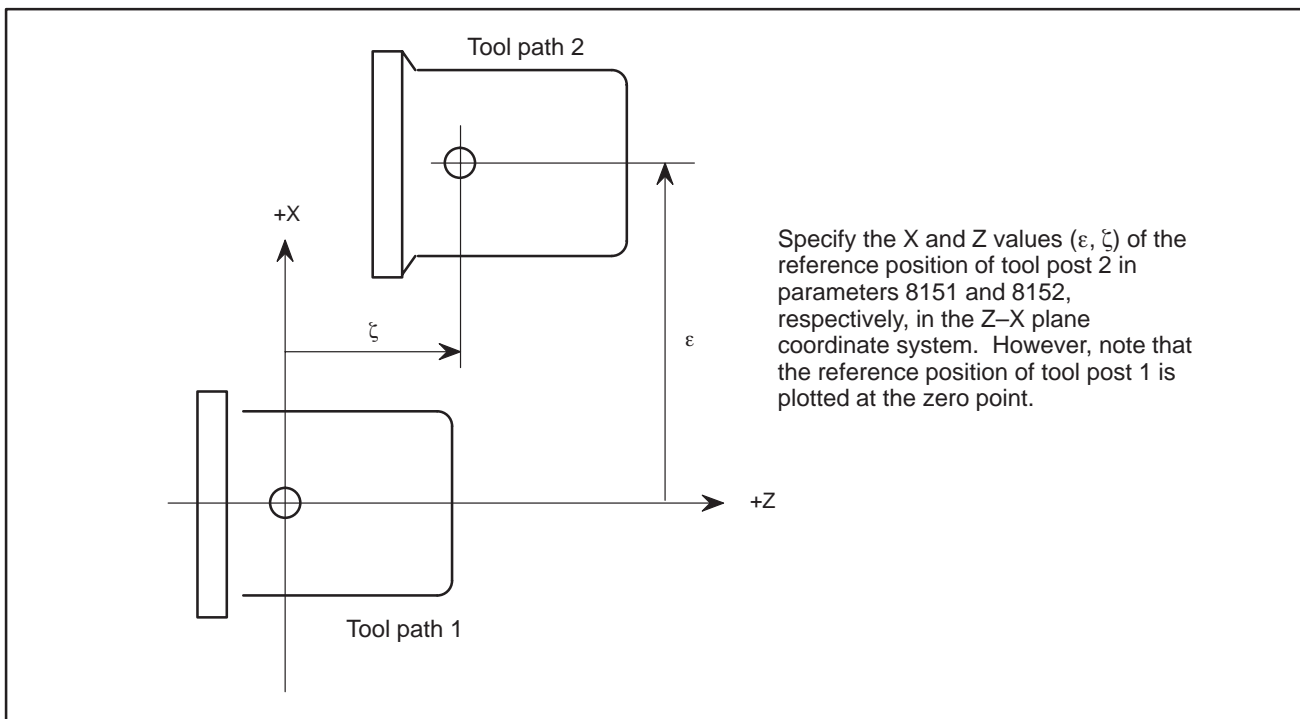

Note

After the parameter values are changed, perform manual reference position return for individual tool posts. Otherwise, data on the positional relationship between the tool posts stored in memory will not be updated to the new parameter values.

4.48 PARAMETERS RELATED TO PATH AXIS REASSIGNMENT

	#7	#6	#5	#4	#3	#2	#1	#0
8160	NRS	SPE				ZSI	XSI	MXC

[Data type] Bit

- MXC** During mixed control of the X- or Z-axis, measurement direct input function B for tool compensation performs calculation based on:
 0 : Machine coordinates for the path being controlled
 1 : Machine coordinates for another path subject to mixed control

Notes

- 1 This parameter is valid for setting tool compensation values for the X- or Z axis and setting shift of the workpiece coordinate system for the Z-axis.
- 2 This parameter cannot be used when mixed control is applied to paths for which different minimum command increments (metric or inch) are specified.

- XSI** When $MXC = 1$, the machine coordinates along the X-axis for the other path subject to mixed control are fetched:
 0 : With the sign as is
 1 : With the sign inverted

- ZSI** When $MXC = 1$, machine coordinates along the Z-axis for the other path subject to mixed control are fetched:
 0 : With the sign as is
 1 : With the sign inverted

- SPE** The synchronization deviation is:
 0 : The difference between the positioning deviation of the master axis and that of the slave axis.
 1 : The difference between the positioning deviation of the master axis and that of the slave axis plus the acceleration/deceleration delay.

Note

When the master and slave axes have different acceleration/deceleration time constants, set 1.

- NRS** When the system is reset, synchronous, composite, or superimposed control is:
 0 : Released.
 1 : Not released.

	#7	#6	#5	#4	#3	#2	#1	#0
8161							CZM	NMR

[Data type] Bit

NMR When an axis subject to mixed control is placed in servo-off state:
 0 : Mixed control is stopped.
 1 : Mixed control is not stopped, provided bit 0 (FUP) of parameter No. 1819 is set to 1 to disable follow-up for the axis.

Note
 Mixed control is not stopped only when bit 0 (FUP) of parameter No. 1819 is set to 1. If follow-up is disabled with the follow-up signal (*FLWU <G007 bit 5> =1), mixed control is stopped.

CZM When two Cs contour axes are subject to mixed control, the function for mixing zero point return commands for Cs contour axes is:
 0 : Not used
 1 : Used

	#7	#6	#5	#4	#3	#2	#1	#0
8162	MUMx	MCDx	MPSx	MPMx	OMRx	PKUx	SERx	SMRx

[Data type] Bit axis

SMRx Synchronous mirror-image control is:
 0 : Not applied. (The master and slave axes move in the same direction.)
 1 : Applied. (The master and slave axes move in opposite directions.)

SERx The synchronization deviation is:
 0 : Not detected.
 1 : Detected.

Note
 When both master and slave axes move in synchronization, the positioning deviations of the corresponding axes are compared with each other. If the difference is greater than or equal to the value specified in parameter No. 8181, an alarm occurs. When either axis is in the parking or machine-locked state, however, the synchronization deviation is not detected.

PKUx In the parking state,
 0 : The absolute, relative, and machine coordinates are not updated.
 1 : The absolute and relative coordinates are updated. The machine coordinates are not updated.

OMRx Superimposed mirror-image control is:
 0 : Not applied. (The superimposed pulse is simply added.)
 1 : Applied. (The inverted superimposed pulse is added.)

MPMx When composite control is started, the workpiece coordinate system is:
 0 : Not set automatically.
 1 : Set automatically.

Note

When the workpiece coordinate system is automatically set at the start of composite control, it is calculated from the following: Current machine coordinates and the workpiece coordinates at the reference point of each axis (parameter No. 8184).

MPSx When composite control is terminated, the workpiece coordinate system is:

0 : Not set automatically.

1 : Set automatically.

Note

When the workpiece coordinate system is automatically set at the end of composite control, it is calculated from the following: Current machine coordinates and the workpiece coordinates at the reference point of each axis under composite control (parameter No. 1250)

MCDx The axes to be replaced with each other under composite control have the coordinate systems placed:

0 : In the same direction. Simple composite control is applied. (The axes of paths 1 and 2 move in the same direction.)

1 : In opposite directions. Mirror-image composite control is applied. (The axes of paths 1 and 2 move in opposite directions.)

This parameter determines the direction in which an axis moves. The parameter is also used to automatically set the coordinate system when composite control is started or terminated.

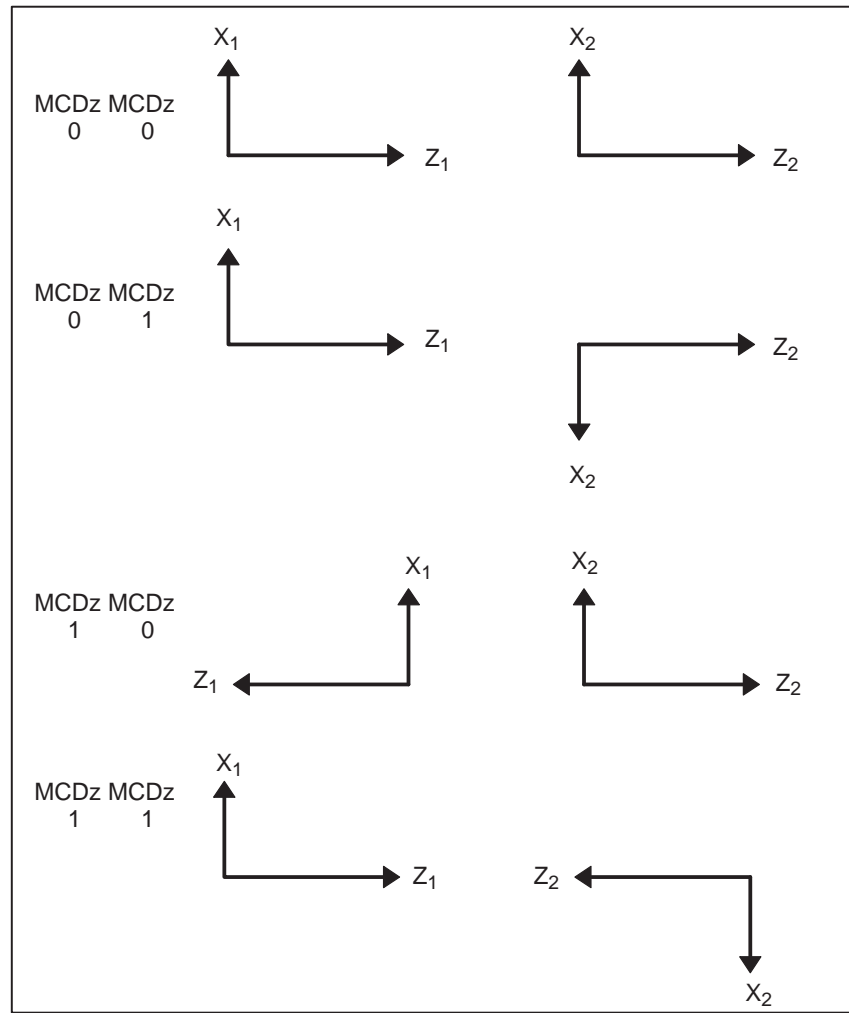

MUMx In mixed control, a move command for the axis:
 0 : Can be specified.
 1 : Cannot be specified.

Note

Upon the execution of a move command along an axis for which MUMx is set to 1 during mixed control, alarm P/S 226 is issued.

	#7	#6	#5	#4	#3	#2	#1	#0
8163	NUMx			SCDx	SCMx	SPSx	SPMx	MDXx

Note

Set the parameters SPMx, SPSx, SCMx, and SCDx for the master axis. These settings are referenced during automatic workpiece coordinate setting for the master axis at the start of synchronous control.

[Data type] Bit axis

MDXx In mixed control, the current position (absolute/relative coordinates) display indicates:

0 : Coordinates in the local system.

1 : Coordinates in the other system under mixed control.

SPMx When synchronous control is started, automatic workpiece coordinate system setting for the master axis is

0 : Not Performed.

1 : Performed.

Note

When a workpiece coordinate system is automatically set at the start of synchronous control, the workpiece coordinate system is calculated from the current machine coordinates and the workpiece coordinates of each axis at the reference position set in parameter No. 8185.

SPSx When synchronous control terminates, automatic workpiece coordinate system setting for the master axis is:

0 : Not performed.

1 : Performed.

Note

When a workpiece coordinate system is automatically set at the end of synchronous control, the workpiece coordinate system is calculated from the current machine coordinates and the workpiece coordinates for each axis at the reference position set in parameter No. 1250.

SCMx When workpiece coordinates are calculated in synchronous control:

0 : The workpiece coordinates are calculated from the machine coordinates of the slave axis.

1 : The workpiece coordinates are calculated from the machine coordinates of the master axis and slave axis.

SCDx The positive (+) directions of the master axis and slave axis in the coordinate system in synchronous control are:

0 : Identical.

1 : Opposite.

NUMx When neither synchronous control nor mixed control is applied, a move command for the axis is:

0 : Not disabled.

1 : Disabled.

Note

If a move command is specified for an axis with NUMx set to 1 when neither synchronous control nor mixed control is applied, P/S alarm No. 226 is issued.

8180	Master axis with which an axis is synchronized under synchronous control
------	--------------------------------------------------------------------------

[Data type] Byte axis

[Valid data range] 1, 2, 3, ... to the maximum number of control axes, or 201, 202, 203, ... to 200 plus the maximum number of control axes

This parameter specifies the number of the master axis with which an axis is synchronized. When zero is specified, the axis does not become a slave axis and is not synchronized with another axis. When an identical number is specified in two or more axes, one master axis has two or more slave axes.

- Exercising synchronous control between two paths
In the parameter of a slave axis, specify the axis number of the master axis with which the slave axis is to be synchronized.
Setting: 1 to 8
The value specified here must not exceed the maximum number of control axes.

(Example 1) Synchronizing the Z₂-axis with the Z₁-axis

Path 1	Path 2
Parameter No. 8180x 0	Parameter No. 8180x 0
Parameter No. 8180z 0	Parameter No. 8180z 2
Parameter No. 8180c 0	
Parameter No. 8180y 0	

- Exercising synchronous control in a path
In the parameter of a slave axis, specify 200 plus the number of the master axis with which the slave axis is to be synchronized.
Setting: 201 to 208
The value specified here must not exceed 200 plus the maximum number of control axes.

(Example 1) Synchronizing the Y₁-axis with the Z₁-axis

Tool post 1	Tool post 2
Parameter No. 8180x 0	Parameter No. 8180x 0
Parameter No. 8180z 0	Parameter No. 8180z 0
Parameter No. 8180c 0	
Parameter No. 8180y 202	

8181	Synchronization error limit of each axis (Synchronous or composite control)
------	-----------------------------------------------------------------------------

[Data type] 2-word axis

[Unit of data] Unit of detection

[Valid data range] 0 to 32767

When the synchronization deviation detected (SERx of Bit #1 parameter No. 8162 is set to 1), this parameter specifies the limit of the difference between the positioning deviation of the slave axis and that of the master axis. Set this parameter to the slave axis.

8182	Display of the synchronization error of an axis (synchronous or composite control)
------	------------------------------------------------------------------------------------

[Data type] 2-word axis

[Unit of data] Unit of detection

[Valid data range] 0 or more

When the synchronization deviation is detected (SERx of Bit #1 parameter No. 8162 is set to 1), this parameter specifies the difference between the positioning deviation of the slave axis and that of the master axis. (The value is used for diagnosis.) The deviation is displayed on the slave side

The parameter is only of display. It should not be set.

The difference between the positioning deviation is:

(Positioning deviation of the master axis) \pm (Positioning deviation of the slave axis)

↑
 Plus for a mirror-image synchronization command
 Minus for a simple synchronization command

8183	Axis under composite control in path 1 corresponding to an axis of path 2
------	---------------------------------------------------------------------------

[Data type] Byte axis

[Valid data range] 1, 2, 3, ... to the maximum number of control axes

This parameter specifies an axis of path 1 to be placed under composite control with each axis of path 2. The value specified here must not exceed the maximum number of axes that can be used in path 1. When zero is specified, control of the axis is not replaced under composite control. An identical number can be specified in two or more axes, but composite control cannot be exercised for all of them at a time.

Note

Specify this parameter only for path 2.

(Example 1) Exercising composite control to replace the X₁-axis with the X₂-axis

Tool post 1	Tool post 2
Parameter No. 8183x 0	Parameter No. 8183x 1
Parameter No. 8183z 0	Parameter No. 8183z 0
Parameter No. 8183c 0	
Parameter No. 8183y 0	

(Example 2) Exercising composite control to replace the Y_1 -axis with the X_2 -axis

Tool post 1		Tool post 2	
Parameter No. 8183x	0	Parameter No. 8183x	4
Parameter No. 8183z	0	Parameter No. 8183z	0
Parameter No. 8183c	0		
Parameter No. 8183y	0		

8184	Coordinates of the reference point of an axis on the coordinate system of another axis under composite control

[Data type] 2-word axis

[Unit of data]

Increment system	IS-A	IS-B	IS-C	Unit
Millimeter machine	0.01	0.001	0.0001	mm
Inch machine	0.001	0.0001	0.00001	inch
Rotation axis	0.01	0.001	0.0001	deg

[Valid range] 0 to 99999999

This parameter specifies the coordinates of the reference point of an axis on the coordinate system of another axis under composite control.

The parameter is validated when MPMx of bit 4 parameter No. 8162 is set to 1.

Example

Exercising composite control to replace the X1-axis with the X2-axis

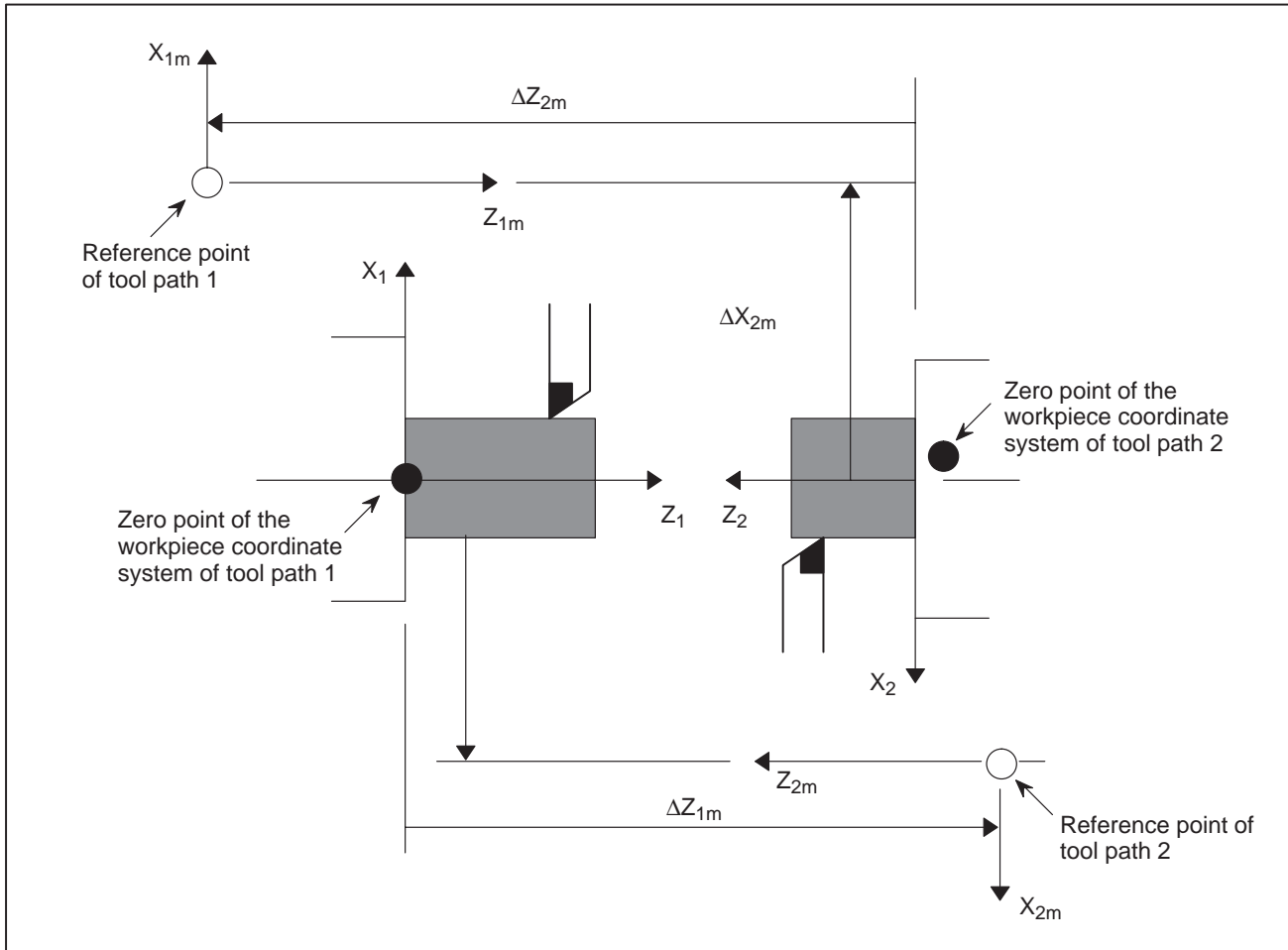

$(\Delta X_{1m}, \Delta Z_{1m})$ are the coordinates of the reference point of tool path 2 on the workpiece coordinate system of tool post 1. $(\Delta X_{2m}, \Delta Z_{2m})$ are the coordinates of the reference point of tool post 1 on the workpiece coordinate system of tool post 2.

ΔX_{1m} is specified for the X-axis of tool post 1 and ΔX_{2m} for the X-axis of tool post 2.

If bit 4 of parameter no. 8162 MPMx is set to 1 when composite control is started, the workpiece coordinate system satisfying the following conditions is specified:

$$X_1 = (\text{Value specified for the X-axis of tool post 1}) \pm (\text{Machine coordinate of } X_2)$$

↑
 Plus when parameter no. 8162 MCDx of tool post 1 is set to 0
 Minus when parameter no. 8162 MCDx of tool post 1 is set to 1

$$X_2 = (\text{Value specified for the X-axis of tool post 2}) \pm (\text{Machine coordinate of } X_1)$$

↑
 Plus when parameter no. 8162 MCDx of tool post 2 is set to 0
 Minus when parameter no. 8162 MCDx of tool post 2 is set to 1

If bit 5 of parameter no. 8162 MPSx is set to 1 when composite control is terminated, the workpiece coordinate system satisfying the following conditions is specified:

$$X_1 = \text{Parameter No. 1250 of tool post 1} + \text{Machine coordinate of } X_1$$

$$X_2 = \text{Parameter No. 1250 of tool post 2} + \text{Machine coordinate of } X_2$$

8185	Workpiece coordinates on each axis at the reference position
------	--------------------------------------------------------------

[Data type] 2-word axis

[Unit of data]

Increment system	IS-A	IS-B	IS-C	Unit
Millimeter machine	0.01	0.001	0.0001	mm
Inch machine	0.001	0.0001	0.00001	inch
Rotation axis	0.01	0.001	0.0001	deg

[Valid data range] -99999999 to 99999999

This parameter sets the workpiece coordinates on each master axis, subject to synchronous control, when the master and slave axes are at the reference position. This parameter is enabled when SPMx of bit 1 parameter No. 8163 is set to 1. Set this parameter for the master axis.

8186	Master axis under superimposed control
------	----------------------------------------

[Data type] Byte axis

[Valid range] 1, 2, 3, ... to number of control axes

This parameter specifies the axis number of the master axis under superimposed control.

When zero is specified, the axis does not become a slave axis under superimposed control and the move pulse of another axis is not superimposed.

8190	Rapid traverse rate of an axis under superimposed control
------	-----------------------------------------------------------

[Data type] 2-word axis

Increment system	Unit of data	Valid data range	
		IS-A, IS-B	IS-C
Millimeter machine	1 mm/min	30 to 240000	30 to 100000
Inch machine	0.1 inch/min	30 to 96000	30 to 48000
Rotation axis	1 deg/min	30 to 240000	30 to 100000

Set a rapid traverse rate for each of the axes when the rapid traverse override of the axes (master and slave axes) under superimposed control is 100%.

8191	F0 velocity of rapid traverse override of an axis under superimposed control

[Data type] Word axis

[Unit of data]	Increment system	Unit of data	Valid data range	
			IS-A, IS-B	IS-C
[Valid data range]	Millimeter machine	1 mm/min	6 to 15000	6 to 12000
	Inch machine	0.1 inch/min	6 to 6000	6 to 4800
	Rotation axis	1 deg/min	6 to 15000	6 to 12000

This parameter specifies the maximum cutting feedrate for an axis under superimposed control.

8192	Linear acceleration/deceleration time constant in rapid traverse of an axis under superimposed control

[Data type] Word axis

[Unit of data] ms

[Valid range] 0 to 4000

This parameter specifies the linear acceleration/deceleration time constant in rapid traverse for each of the axes (master and slave axes) under superimposed control.

8193	Maximum cutting feedrate under superimposed control

[Data type] 2 words

[Unit of data and valid range]

Increment system	Unit of data	Valid range	
		IS-A, IS-B	IS-C
Millimeter machine	1 mm/min	30 to 240000	30 to 100000
Inch machine	0.1 inch/min	30 to 76000	30 to 48000
Rotation axis	1 deg/min	30 to 240000	30 to 100000

This parameter specifies the maximum cutting feedrate under superimposed control.

8194

Maximum cutting feedrate of an axis under superimposed control

[Data type] 2-word axis**[Unit of data and valid range]**

Increment system	Unit of data	Valid range	
		IS-A, IS-B	IS-C
Millimeter machine	1 mm/min	6 to 240000	6 to 100000
Inch machine	0.1 inch/min	6 to 96000	6 to 48000
Rotation axis	1 deg/min	6 to 240000	6 to 100000

This parameter specifies the maximum cutting feedrate for an axis under superimposed control.

4.49 PARAMETERS FOR ANGULAR AXIS CONTROL

	#7	#6	#5	#4	#3	#2	#1	#0
8200						AZR		AAC

Note

When this parameter is set, the power must be turned off before operation is continued.

[Data type] Bit

AAC

- 0 : Does not perform angular axis control.
- 1 : Performs inclined axis control.

AZR

- 0 : The machine tool is moved along the Cartesian axis during manual reference position return along the slanted axis under angular axis control.
- 1 : The machine tool is not moved along the Cartesian axis during manual reference position return along the slanted axis under angular axis control.

8210	Inclination angle for angular axis control
------	--------------------------------------------

[Data type] 2 words

[Unit of data] 0.001 degree

[Valid data range] 20000 to 60000

8211	Axis number of a slanted axis subject to slanted axis control
------	---------------------------------------------------------------

8212	Axis number of a Cartesian axis subject to slanted axis control
------	-----------------------------------------------------------------

[Data type] Word

[Unit of data] Number

[Valid data range] 1 to number of controlled axes

These parameters set the axis numbers of a slanted axis and Cartesian axis subject to slanted axis control.

4.50 PARAMETERS RELATED TO B-AXIS CONTROL

	#7	#6	#5	#4	#3	#2	#1	#0
8240	MST	ABS	SOV	TEM	REF			

[Data type] Bit

- REF** Reference position return operation by G28:
 0 : Always uses deceleration dogs in the same way as a manual reference position return operation.
 1 : Uses deceleration dogs when a reference position has not yet been set, but is performed by rapid traverse when a reference position has already been set (in the same way as an ordinary G28 command).
- TEM** When an offset movement is made in a block containing a T code:
 0 : M code and MF are output before a movement along an axis.
 1 : M code and MF are output after a movement along an axis.
- SO** A G110 block:
 0 : Overlaps the next block.
 1 : Does not overlap the next block.
- ABS** The B-axis command is:
 0 : An incremental command.
 1 : An absolute command.
- MST** When an M code for starting a movement along the B-axis is specified:
 0 : Operation is started after a ready notice using the FIN signal is received.
 1 : Operation is started without waiting for a ready notice.

	#7	#6	#5	#4	#3	#2	#1	#0
8241						MDF	MDG	FXC

[Data type] Bit

- FXC** In canned cycle G84:
 0 : The spindle is rotated clockwise or counterclockwise after M05 is output.
 1 : The spindle is rotated clockwise or counterclockwise without first outputting M05.
- MDG** The initial continuous-state value for starting B-axis operation command registration is:
 0 : G00 mode (rapid traverse).
 1 : G01 mode (cutting feed).
- MDF** The initial continuous-state value for starting B-axis operation command registration is:
 0 : G98 (feed per minute).
 1 : G99 (feed per rotation).

	#7	#6	#5	#4	#3	#2	#1	#0
8242								COF

[Data type] Bit

COF For tool post 1 and tool post 2 (under two-path control):

- 0 : A separate B-axis offset value is set.
- 1 : A common B-axis offset value is set.

8250	Axis number used for B-axis control

[Data type] Byte

[Valid data range] 1 to number of controlled axes (in one-system control)
 11 to ((number of controlled axes for tool post 1) + 11), or
 21 to ((number of controlled axes for tool post 2) + 20) (in two-path control)

This parameter sets which axis is to be used for B-axis control.

In one-system control, set the controlled axis number of a selected B-axis.

In two-path control, set the axis number, used for B-axis control on tool post 1, added to 10 when a tool post 1 axis is used.

Set an axis number, used for B-axis control on tool post 2, added to 20 when a tool post 2 axis is used.

Example of setting:

- (1) For one-system control
 When the fourth axis is controlled as the B-axis, set 4 in this parameter. Furthermore, specify a DI/DO number to be used for the fourth axis in parameter No. 8010.
- (2) For two-path control
 - (a) When B-axis control is applied to tool post 1 only
 When the fourth axis of tool post 1 is controlled as the B-axis, set 14 with this parameter. Furthermore, specify the DI/DO number to be used for the fourth axis with parameter No. 8010 for tool post 1.
 - (b) When B-axis control is applied to tool post 2 only
 When the fourth axis on tool post 2 is controlled as the B-axis, set 24 with this parameter. Furthermore, specify a DI/DO number to be used for the fourth axis in parameter No. 8010 for tool post 2.
 - (c) When B-axis control is applied separately to tool post 1 and tool post 2
 Make the settings described in (a) and (b) above.
 - (d) When B-axis control is simultaneously applied to both tool post 1 and tool post 2
 When the fourth axis for tool post 1 is controlled as the common B-axis, set 14 with this parameter for both tool post 1 and tool post 2. Furthermore, specify a DI/DO number to be used for the fourth axis in parameter No. 8010 for tool post 1.

8251	M code (G101) for specifying the start of first program operation
8252	M code (G102) for specifying the start of second program operation
8253	M code (G103) for specifying the start of third program operation

[Data type] 2-word

[Valid data range] 6 to 99999999

These parameters set M codes for starting previously registered B-axis operation programs. M codes (such as M30, M98, and M99), already used for other purposes, cannot be set.

8257	T code number for tool offset cancellation
------	--------------------------------------------

[Data type] Byte

[Valid data range] 0 to 90

This parameter sets a T code number for tool offset cancellation. When a T code from (setting + 1) to (setting + 9) is specified, tool offset is specified.

8258	Clearance, used in canned cycle G83, for the B-axis
------	-----------------------------------------------------

[Data type] 2-word

[Valid data range] 0 to 99999999

[Unit of data]

Increment system	IS-B	IS-C	Unit
Millimeter machine	0.001	0.0001	mm
Inch machine	0.0001	0.00001	inch

This parameter sets the clearance used for peck drilling cycle G83.

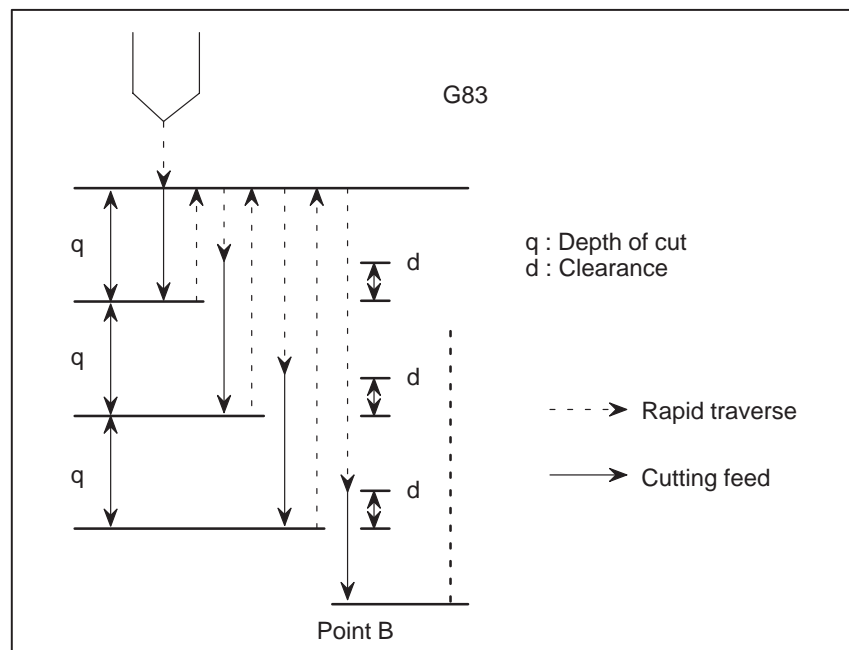

4.51 PARAMETERS OF SIMPLE SYNCHRONOUS CONTROL

	#7	#6	#5	#4	#3	#2	#1	#0
8301								
	SOR							

[Data type] Bit

SY1	SY0	
0	0	The simple synchronous control is not performed.
0	1	The X axis is the master axis. (The fourth axis synchronizes the X axis.)
1	0	The Y axis is the master axis. (The fourth axis synchronizes the Y axis.)
1	1	The Z axis is the master axis. (The fourth axis synchronizes the Z axis.)

SOF The synchronization function is:
 0 : Not used.
 1 : Used.

	#7	#6	#5	#4	#3	#2	#1	#0
8302								
							ATS	ATE

Note

When this parameter is set, the power must be turned off before operation is continued.

[Data type] Bit

ATE Automatic setting of grid positioning for simplified synchronous control is:
 0 : Disabled
 1 : Enabled

ATS Automatic setting of grid positioning for simplified synchronous control is:
 0 : Not started
 1 : Started

Note

- 1 When the bits are set to 1, parameter No. 8316 and bit 4 (APZx) of parameter No. 1815 for the master and slave axes are set to 0.
- 2 These bits are automatically set to 0 once grid positioning has been completed.

8311

Axis number of master axis in synchronous control

[Data type] Byte axis**<For the T system>**

Select a master axis and slave axis for simple synchronous control. Set a master axis number for the axis used as a slave axis. Set the parameters for the first to fourth axes with parameter No. 8311, as follows:

Units digit in the parameter for the first axis

→ Set the master axis number for the first axis.

Tens digit in the parameter for the first axis

→ Set the master axis number for the second axis.

Units digit in the parameter for the second axis

→ Set the master axis number for the third axis.

Tens digit in the parameter for the second axis

→ Set the master axis number for the fourth axis.

Units digit in the parameter for the third axis

→ Set the master axis number for the fifth axis.

Tens digit in the parameter for the third axis

→ Set the master axis number for the sixth axis.

Units digit in the parameter for the fourth axis

→ Set the master axis number for the seventh axis.

Tens digit in the parameter for the fourth axis

→ Set the master axis number for the eighth axis.

Number	Tens digit	Units digit
First	Second axis	First axis
Second	Fourth axis	Third axis
Third	Sixth axis	Fifth axis
Fourth	Eighth axis	Seventh axis

The axis number settings are: 0 for the first axis, 1 for the second axis, 2 for the third axis, and so on.

Note

For an axis for which 0 is specified, the first axis is the master axis. This means that when the synchronous control signal for the axis is set to 1, the first axis becomes the master axis for synchronous control.

<For the M system>

[Valid data range] 0, 1 to number of controlled axes

Select a master axis and slave axis for simple synchronous control. Set a master axis number for the slave axis side. The axis number settings are: 1 for the first axis, 2 for the second axis, 3 for the third axis, and so on.

Example

When using the first axis (X-axis) as the master axis, and the third axis (Z-axis) as the slave axis, set parameter No. 8311 as follows:

Parameter No. 8311 X (first axis) = 0

Parameter No. 8311 Y (second axis) = 0

Parameter No. 8311 Z (third axis) = 1

Parameter No. 8311 A (fourth axis) = 0

Note

Specifying the third axis (Z-axis) as the master axis, and the first axis (X-axis) as the slave axis is not allowed. The master axis number must always be smaller than the slave axis number.

8312	Enabling/disabling mirror image in synchronous control
------	--------------------------------------------------------

[Data type] Byte axis

[Valid data range] -127 - +128

This parameter sets the mirror image function. When 100 or a greater value is set with this parameter, the mirror image function is applied to synchronous control. Set this parameter to the slave axis.

Example

To establish reversed synchronization when using the third axis as the master axis and the fourth axis as the slave axis, set parameter No. 8311 and parameter No. 8312 as follows:

Parameter No. 8311 (first axis) = 0

Parameter No. 8311 (second axis) = 20

Parameter No. 8311 (third axis) = 0

Parameter No. 8311 (fourth axis) = 0

Parameter No. 8312 (first axis) = 0

Parameter No. 8312 (second axis) = 0

Parameter No. 8312 (third axis) = 0

Parameter No. 8312 (fourth axis) = 100

8313	Limit of the difference between the amount of positioning deviation of the master and slave axes
------	--------------------------------------------------------------------------------------------------

[Data type] Word

[Unit of data] Detection unit

[Valid data range] 0 to 32767

Set the limit of the difference between the amount of positioning deviation of the master and slave (fourth) axes. If the difference between them exceeds the limit assigned to the parameter, the alarm (No. 213) is activated.

8314

Allowable error in synchronization error check

[Data type] Word axis

[Unit of data] Detection unit

[Valid data range] 0 to 32767

This parameter sets, in the detection unit, the allowable error when a synchronization error check is made. The mechanical coordinates of the master axis and slave axis are monitored. When a synchronization error equal to or greater than the value set in this parameter is detected, servo alarm No. 407 is issued, and the machine is stopped. Set this parameter for the master axis. When 0 is set with this parameter, no synchronization error check is performed.

8315

Maximum compensation value for synchronization

Note

When this parameter is set, the power must be turned off before operation is continued.

[Data type] Word axis

[Unit of data] Unit used for the detection

[Valid data range] 0 to 32767

This parameter sets the maximum compensation value for synchronization. When a compensation value greater than the value set in this parameter is used, servo alarm No. 407 is issued.

8316

Difference between reference counters for master and slave axes

Note

When this parameter is set, the power must be turned off before operation is continued.

[Data type] 2-word

[Data unit] Detection unit

[Valid data range] -99999999 to 99999999

This parameter indicates the difference between the values in the reference counter for the master axis and that for the slave axis.

Note

Once grid positioning has been completed, the difference between the reference counters is automatically set in this parameter. At this time, bit 1 (ATS) of parameter No. 8302 is set to 0.

8317	
	Torque difference alarm detection time

[Data type] Word

[Data unit] ms

[Valid data range] 0 to 4000 (When 0 is set, 512 ms is assumed.)

This parameter specifies the period between the servo preparation completion signal (SA <F000 bit 6>) being set to 1 and the check of the torque difference alarm being started, for the torque difference alarm detection function.

The set value is rounded up to the nearest a multiple of 16 ms.

[Example]

When 100 is specified, 112 ms is assumed.

4.52 PARAMETERS OF RELATED TO CHECK TERMINATION

8341

Program number subject to check termination

[Data type] Word**[Valid data range]** 0 to 9999

This parameter sets the program number, including a sequence number, subject to sequence number check termination. Parameter No. 8342 is used to set a sequence number subject to check termination.

Note

A program number can also be set on the setting screen. If a program number is set on the setting screen, the value of the parameter is changed accordingly.

8342

Sequence number subject to check termination

[Data type] 2-word**[Unit of data]****[Valid data range]** 0 to 9999

This parameter sets the sequence number subject to sequence number check termination.

If the block containing the sequence number set with this parameter is executed while the program set with parameter No. 8341 is being executed, a single block stop occurs after the block is executed. At this time, the setting is automatically set to -1. Upon power-up, the setting is automatically set to 0.

Note

A sequence number can also be set by using the setting screen. If a sequence number is set on the setting screen, the value of the parameter is changed accordingly.

4.53 CHOPPING PARAMETERS

8343	Program number where collation is to be stopped (when an 8-digit program number is used)
------	------------------------------------------------------------------------------------------

[Data type] 2-word

[Valid data range] 0 to 99999999

This parameter specifies an 8-digit program number where collation is to be stopped.

Note

Do not use parameter No. 8341, which is dedicated to the standard function (4-digit O number).

	#7	#6	#5	#4	#3	#2	#1	#0
8360	CHPX							CPRPD

[Data type] Bit

CPRPD For the chopping function, a rapid traverse override for a section from the current position to the R point is determined as follows:

0 : A chopping override is enabled.

1 : An ordinary rapid traverse override is enabled.

CHPX On the chopping screen, the chopping speed can:

0 : Be set.

1 : Not be set.

8370	Chopping axis
------	---------------

[Data type] Byte

[Valid data range] 1 to the number of controlled axes

This parameter specifies which servo axis the chopping axis corresponds to.

8371	Chopping reference point (R point)
------	------------------------------------

8372	Chopping upper dead point
------	---------------------------

8373	Chopping lower dead point
------	---------------------------

[Data type] 2-word

[Valid data range]

Increment system	IS-A	IS-B	IS-C	Unit
Metric machine	0.01	0.001	0.0001	mm
Inch machine	0.001	0.0001	0.00001	inch
Rotation axis	0.01	0.001	0.0001	deg

[Valid data range] –99999999 to 99999999

The data set in these parameters are absolute coordinates.

8374	Chopping speed
------	----------------

[Data type] 2–word

[Unit of data]

Increment system	Unit
Linear axis (metric input)	1.00 mm/min
Linear axis (inch input)	0.01 inch/min

Valid data range : For IS–A and –B, 240000 mm/min or 9600 inches/min
For IS–C, 100000 mm/min or 4800 inches/min

8375	Maximum chopping feedrate
------	---------------------------

[Data type] 2–word

[Unit of data]

[Valid data range]

Increment system	Unit of data	Valid data range	
		IS–A, IS–B	IS–C
Metric machine	1 mm/min	30 to 240000	30 to 100000
Inch machine	0.1 inch/min	30 to 96000	30 to 48000
Rotation axis	1 deg/min	30 to 240000	30 to 100000

The chopping speed is clamped at a value specified in this parameter.
When the parameter is 0, no chopping operation occurs.

8376	Chopping compensation scaling factor
------	--------------------------------------

[Data type] Byte

[Unit of data] %

[Valid data range] 0 to 100

This parameter specifies a scaling factor used to multiply the compensation value for a servo delay or acceleration/deceleration delay in an chopping operation. When this parameter is 0, servo delay compensation will not be applied.

8377	Compensation start tolerance
------	------------------------------

[Data type] Word

[Unit of data]

Increment system	IS–A	IS–B	IS–C	Unit
Metric machine	0.01	0.001	0.0001	mm
Inch machine	0.001	0.0001	0.00001	inch
Rotation axis	0.01	0.001	0.0001	deg

[Valid data range] 0 to 32767

Compensation is applied when the difference between an amount of shortage at the upper dead point and that at the lower dead point is less than the value specified in this parameter. In other words, this parameter is used to enable compensation after the chopping operation settles. When the parameter is 0, compensation will not be applied.

4.54 PARAMETERS OF HIGH-SPEED HIGH-PRECISION CONTOUR CONTROL BY RISC (16-MB)

(1) Parameters of acceleration and deceleration before interpolation

8400	
	Parameter 1 for determining a linear acceleration/deceleration before interpolation

[Data type] 2-word

[Unit of data]

[Valid range]

Increment system	Unit	Valid range	
		IS-B	IS-C
Millimeter machine	1 mm/min	10 to 60000	1 to 6000
Inch machine	0.1 inch/min	10 to 60000	1 to 6000
Rotation axis	1 deg/min	10 to 60000	1 to 6000

This parameter determines a linear acceleration and deceleration before interpolation. Usually, set the maximum cutting speed (parameter No. 1422).

8401	
	Parameter 2 for determining a linear acceleration/deceleration before interpolation

[Data type] Word

[Unit of data] 1 ms

[Valid range] 0 to 4000

This parameter specifies the time required until the speed specified in parameter 1 is achieved.

Note

The function for linear acceleration/deceleration before interpolation is canceled when either parameter no. 8400 or 8401 is set to 0.

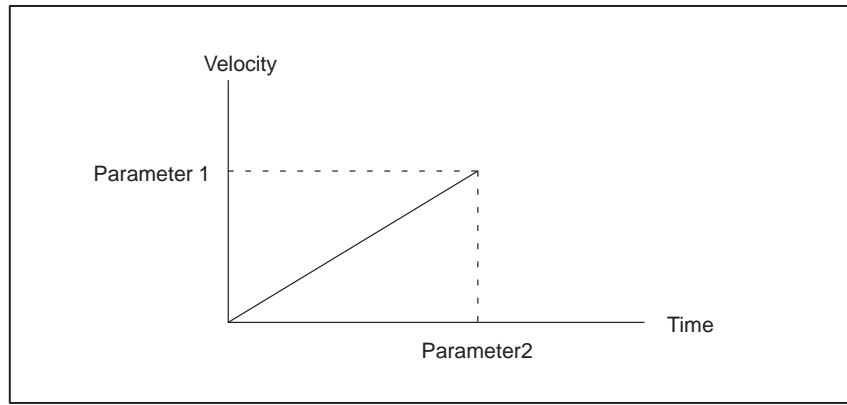

	#7	#6	#5	#4	#3	#2	#1	#0
8402								
	BADO		DST	BLK			NWBL	

[Data type] Bit

NWBL, BADO Select the type of acceleration/deceleration before interpolation.

BADO	NWBL	Meaning
0	0	Linear type is used for acceleration/deceleration prior to pre-read interpolation
1	1	Bell-shape type is used for acceleration/deceleration prior to pre-read interpolation

BLK Be sure to set 0.

DST Be sure to set 1.

	#7	#6	#5	#4	#3	#2	#1	#0
8403								
	SGO				PLC2	PLC1	MSU	

[Data type] Bit

MSU When G00, or an M, S, T, or B code is specified in HPCC mode:

0 : An alarm is issued.

1 : The CNC executes the command.

PLC1 In HPCC mode, a strokek check before movement for stored stroke limit 1 is:

0 : Not performed.

1 : Performed.

PLC2 In HPCC mode, a strokek check before movement for the stored stroke limit is -2:

0 : Not performed.

1 : Performed.

SG0 When G00 is specified in HPCC mode:

0 : The setting of bit 1 (MSU) of parameter No. 8403 is followed.

1 : The tool is moved along the axis at the feedrate set with parameter No. 8481, replacing the G00 command with the G01 command, regardless of the setting made for bit 1 (MSU) of parameter No. 8403.

(2) Parameters of automatic velocity setting

8410	Allowable velocity difference in velocity determination considering the velocity difference at corners
------	--------------------------------------------------------------------------------------------------------

[Data type] Word axis

[Unit of data]

[Valid range]

Increment system	Unit	Valid range	
		IS-B	IS-C
Millimeter machine	1 mm/min	10 to 60000	1 to 6000
Inch machine	0.1 inch/min	10 to 60000	1 to 6000
Rotation axis	1 deg/min	10 to 60000	1 to 6000

If zero specified for all axes, the machine does not decelerate at corners.

When the function for determining the velocity considering the velocity difference at corners is used, the system calculates the feedrate whereby a change in the velocity element of each axis does not exceed this parameter value at the interface between blocks. Then the machine decelerates using acceleration/deceleration before interpolation.

8416	Look-ahead bell-shaped acceleration/deceleration before interpolation
------	-----------------------------------------------------------------------

[Data type] 2-word

[Unit of data] ms

[Valid range] 0 to 99999999

This parameter sets the time required to reach the feedrate set with parameter No. 8400 or No. 8401 in look-ahead bell-shaped

8451	#7	#6	#5	#4	#3	#2	#1	#0
	NOF			ZAG				USE

Setting point

[Data type] Bit

USE Automatic velocity control is:

0 : Not applied.

1 : Applied.

ZAG The velocity is:

0 : Not determined according to the angle at which the machine descends along the Z-axis.

1 : Determined according to the angle at which the machine descends along the Z-axis.

NOF In a block where automatic velocity control is validated, the F command is:

0 : Validated.

1 : Ignored.

8452								
	Range of velocity fluctuation to be ignored							

Setting input

[Data type] Byte

[Unit of data] %

[Valid range] 0 to 100 (Standard setting: 10)

8456								
	Area-2 override							

[Data type] Word

[Unit of data] %

[Valid range] 0 to 100 (Standard setting: 80)

This parameter specifies an override in area 2 of velocity calculation considering the cutting load.

8457								
	Area-3 override							

[Data type] Word

[Unit of data] %

[Valid range] 0 to 100 (Standard setting: 70)

This parameter specifies an override in area 3 of velocity calculation considering the cutting load.

8458								
	Area-4 override							

[Data type] Word

[Unit of data] %

[Unit of data] 0 to 100 (Standard setting: 60)

This parameter specifies an override in area 4 of velocity calculation considering the cutting load.

	#7	#6	#5	#4	#3	#2	#1	#0
8459							CTY	CDC

[Data type] Bit

CDC Be sure to set to 0.

CTY Be sure to set to 1.

8464	
	Initial feedrate for automatic feedrate control

[Data type] 2-word

[Unit of data and valid range]

Increment system	Unit	Valid range	
		IS-B	IS-C
Millimeter machine	1 mm/min	0 to 600000	0 to 60000
Inch machine	0.1 inch/min	0 to 600000	0 to 60000
Rotation axis	1 deg/min	0 to 600000	0 to 60000

This parameter sets the initial feedrate for automatic feedrate control.

In automatic feedrate control, the initial feedrate set with this parameter is used at the beginning if no F command is specified in the program. Usually, set the maximum cutting feedrate (specified in parameter No. 1422).

8465	Maximum allowable feedrate for automatic feedrate control
------	-----------------------------------------------------------

[Data type] 2-word

[Unit of data and valid range]

Increment system	Unit	Valid range	
		IS-B	IS-C
Millimeter machine	1 mm/min	0 to 600000	0 to 60000
Inch machine	0.1 inch/min	0 to 600000	0 to 60000
Rotation axis	1 deg/min	0 to 600000	0 to 60000

This parameter sets the maximum allowable feedrate for automatic feedrate control. Usually, set the maximum allowable cutting feedrate (set in parameter No. 1422).

8470	Parameter for determining allowable acceleration in velocity calculation considering acceleration
------	---------------------------------------------------------------------------------------------------

[Data type] Word axis

[Unit of data] ms

[Valid range] 0 to 32767

When the function for calculating the velocity considering the acceleration is used under automatic velocity control, this parameter is used to determine the allowable acceleration. The time required until the maximum cutting speed (parameter No. 1422) is reached must be specified here.

	#7	#6	#5	#4	#3	#2	#1	#0
8475								
					CIR	BIP		

[Data type] Bit

CIR The function of automatic velocity control considering acceleration and deceleration during circular interpolation is:

0 : Not used.

1 : Used.

When 1 is set, parameter No. 8470 for determining the allowable acceleration must be specified.

BIP The function of deceleration at corners is:

0 : Not used.

1 : Used. (Always set 1.)

	#7	#6	#5	#4	#3	#2	#1	#0
8480								
		RI2	RI1	RI0				

Note

When this parameter is set, the power must be turned off before operation is continued.

[Data type] Bit

RI2, RI1, RI0 Always set the following values.

	RI2	RI1	RI0
Setting	0	1	0

8481	
	Rapid traverse rate in HPCC mode

[Data type] 2-word axis

[Unit of data and valid range]

Increment system	Unit	Valid range	
		IS-B	IS-C
Millimeter machine	1 mm/min	0 to 600000	0 to 60000
Inch machine	0.1 inch/min	0 to 600000	0 to 60000
Rotation axis	1 deg/min	0 to 600000	0 to 60000

When bit 7 (SG0) of parameter No. 8403 is set to 1, this parameter sets the rapid traverse rate in the HPCC mode.

Note

The G00 command is replaced with the G01 command before execution. So, even if feedrate is specified for two axes, the rapid traverse rate set with this parameter is always used.

[Example]

If the following command is specified when a rapid traverse rate of 1000 mm/min is set F1000, rather than F1414, is used:

G00 X100.Y100.;

	#7	#6	#5	#4	#3	#2	#1	#0
8485			CDSP					

[Data type] Bit

CDSP 0 : Disables smooth interpolation in HPCC mode.

1 : Enables smooth interpolation in HPCC mode.

To apply smooth interpolation, be sure to set this parameter to 1.

8486	Maximum travel distance of a block where smooth interpolation is applied
------	--------------------------------------------------------------------------

[Data type] 2-word

[Unit of data] Least input increment (depending on the set reference axis)

[Valid data range] 0 to 99999999

This parameter specifies a block length used as a reference to decide whether to apply smooth interpolation. If the line specified in a block is longer than the value set in the parameter, smooth interpolation will not be applied to that block. This parameter can be used, for example, to specify the maximum line length of a folded line to which a metal die workpiece is approximated with some tolerance.

(3) Parameters of axis control

7510	Maximum number of axes controlled by RISC
------	-------------------------------------------

[Data type] Byte

[Valid range] 1, 2, 3, ... to the maximum number of control axes

This parameter specifies the maximum number of axes to be controlled by RISC.

[Example]

Six axes are provided. Starting from the first axis, they are the X-axis, Y-axis, Z-axis, A-axis, B-axis, and C-axis. To control the fourth axis (A-axis) by RISC, specify 4. When 4 is specified, X-, Y-, and Z-axes are also controlled by RISC.

X-, Y-, Z-, and A-axes: Controlled by RISC

B- and C-axes: Not controlled by RISC

4.55 OTHER PARAMETERS

	#7	#6	#5	#4	#3	#2	#1	#0
8650							CNA	RSK

[Data type] Bit

RSK When the RESET key is pressed, the key code is:

0 : Not passed to the application.

1 : Passed to the application.

Note

This parameter is used with the C executor. Any modifications to the value set for this parameter does not become effective until after the system is next powered on.

CNA When an NC alarm is issued during the display of the user screen for the C executor:

0 : The NC alarm screen can be displayed depending on the setting of bit 7 (NPA) of parameter No. 3111.

1 : The NC alarm screen is not displayed.

Note

This parameter is used only for the C executor.

	#7	#6	#5	#4	#3	#2	#1	#0
8701		CTV					PLD	
							PLD	

[Data type] Bit

PLD When the P-code loader function is used (macro compiler/executor):

0 : AM is initialized and the entire contents of RAM are rewritten.

1 : RAM is not initialized, being overwritten instead

CTV When CAP II is provided, 1 must be specified.

	#7	#6	#5	#4	#3	#2	#1	#0
8703							LCL	DLF

[Data type] Bit

DLF If an incomplete program file is created because program registration, performed via a communication board such as MAP is interrupted by a reset or alarm, the file is:

0 : Not deleted.

1 : Deleted.

Note

This parameter is used with the OSI/Ethernet function.

LCL When a change in the internal state of the CNC (such as a change in the number of part programs or selected programs) occurs, information about the change is:

0 : Not sent to the host.

1 : Sent to the host.

Note

This parameter is used with the OSI/Ethernet function.

8760

Program number for data registration (data input/output function using the I/O link)

[Data type] Word

[Valid data range] 0 to 9999

When the data input/output function using the I/O link is used, this parameter sets the program numbers of the programs to be used for registering data (parameters, macro variables, and diagnostic data) from Power Mates.

For a Power Mate in group n , the following program numbers are used:

For parameters: $\text{Setting} + n \times 10 + 0$

For macro variables: $\text{Setting} + n \times 10 + 1$

For diagnostic data: $\text{Setting} + n \times 10 + 2$

Example: When 8000 is set

8000: Parameters of group 0 (I/O channel = 20)

8001: Macro variables of group 0 (I/O channel = 20)

8002: Diagnostic data of group 0 (I/O channel = 20)

8010: Parameters of group 1 (I/O channel = 21)

8011: Macro variables of group 1 (I/O channel = 21)

8012: Diagnostic data of group 1 (I/O channel = 21)

8020: Parameters of group 2 (I/O channel = 22)

8021: Macro variables of group 2 (I/O channel = 22)

8022: Diagnostic data of group 2 (I/O channel = 22)

8150: Parameters of group 15 (I/O channel = 35)

8151: Macro variables of group 15 (I/O channel = 35)

8152: Diagnostic data of group 15 (I/O channel = 35)

Note

When 0 is set, the input/output of parameters, macro variables, and diagnostic data cannot be performed, but program input/output processing is performed.

8781	Amount of DRAM used with the C executor
------	-----------------------------------------

Note
When this parameter is set, the power must be turned off before operation is continued.

[Data type] Byte
[Unit of data] 64k Byte
[Valid data range] 16 to 64

This parameter sets the amount of DRAM to be used by the C executor. Specify a size of no less than 1024K bytes, in multiples of 64K bytes. If a value that exceeds the valid data range is specified, 0 is assumed.

Note
The available size depends on the amount of installed DRAM and the selected options.

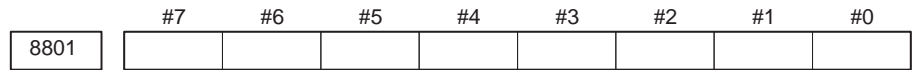

[Data type] Bit
 Bit parameter 1 for machine tool builder



[Data type] Bit
 Bit parameter 2 for machine tool builder

Note
These parameters are used only by the machine tool builder. Refer to the relevant manual supplied by the machine tool builder for details.

8811	2-word parameter 1 for machine tool builder
8812	2-word parameter 2 for machine tool builder
8813	2-word parameter 3 for machine tool builder

[Data type] 2-word
[Valid data range] -99999999 to 99999999

Note
These parameters are used only by the machine tool builder. Refer to the relevant manual supplied by the machine tool builder for details.

4.56 PARAMETERS FOR MAINTENANCE

	#7	#6	#5	#4	#3	#2	#1	#0
8901								FAN

[Data type] Bit

FAN A fan motor error is:

0 : Detected. (When the fan motor error is detected, an overheating alarm occurs.)

1 : Not detected. (Use inhibited)

A CHARACTER CODE LIST

Character	Code	Comment	Character	Code	Comment
A	065		6	054	
B	066		7	055	
C	067		8	056	
D	068		9	057	
E	069			032	Space
F	070		!	033	Exclamation mark
G	071		"	034	Quotation marks
H	072		#	035	Shape
I	073		\$	036	Dollar mark
J	074		%	037	Percent
K	075		&	038	Ampersand
L	076		'	039	Apostrophe
M	077		(040	Left parenthesis
N	078)	041	Right parenthesis
O	079		*	042	Asterisk
P	080		+	043	Positive sign
Q	081		,	044	Comma
R	082		-	045	Negative sign
S	083		.	046	Period
T	084		/	047	Slash
U	085		:	058	Colon
V	086		;	059	Semicolon
W	087		<	060	Left angle bracket
X	088		=	061	Equal sign
Y	089		>	062	Right angle bracket
Z	090		?	063	Question mark
0	048		@	064	Commercial at mark
1	049		[091	Left square bracket
2	050		^	092	
3	051		¥	093	Yen mark
4	052]	094	Right square bracket
5	053			095	Underline

[C]

Character Code List, 321
Chopping Parameters, 307

[D]

Description of Parameters, 8
Displaying Parameters, 1

[E]

Exponential Interpolation Parameters, 220

[I]

Inputting and Outputting Parameters Through the Reader/Puncher Interface, 5
Inputting Parameters through the Reader/Puncher Interface, 7

[O]

Other Parameters, 317
Outputting Parameters through the Reader/Puncher Interface, 6

[P]

Parameter for Involute Interpolation, 219
Parameter of External Data Input/Output, 238
Parameter of Skip Function, 231
Parameters for Angular Axis Control, 296
Parameters for Checking Interference between Tool Posts (Two-path Control), 282
Parameters for Maintenance, 320
Parameters of Acceleration/ Deceleration Control, 72
Parameters of Automatic Tool Compensation (16-TB) and Automatic Tool Length Compensation (16-MB), 236
Parameters of Axis Control by PMC, 276
Parameters of Axis Control/ Increment System, 32
Parameters of Canned Cycles, 186
Parameters of Coordinates, 48
Parameters of Crt/Mdi, Display, and Edit, 110
Parameters of Custom Macros, 223

Parameters of Di/Do, 106
Parameters of Displaying Operation Time and Number of Parts, 243
Parameters of Feedrate, 60
Parameters of Graphic Display, 238
Parameters of High-Speed High-Precision Contour Control by RISC (16-MB), 310
Parameters of High-Speed Machining (High-Speed Cycle Machining/High-S peed Remote Buffer), 263
Parameters of Indexing Index Table, 217
Parameters of Manual Handle Feed, Handle Interruption and Handle Feed in Tool Axial Direction, 253
Parameters of Manual Operation and Automatic Operation, 252
Parameters of Normal Direction Control, 215
Parameters of Pitch Error Compensation, 136
Parameters of Polar Coordinate Interpolation, 213
Parameters of Polygon Turning, 266
Parameters of Position Switch Functions, 249
Parameters of Programs, 128
Parameters of reader/puncher interface, remote buffer, dnc1, dnc2, and m-net interface, 14
Parameters of Related to Check Termination, 306
Parameters of Rigid Tapping, 197
Parameters of Scaling/Coordinate Rotation, 210
Parameters of Servo, 90
Parameters of Setting , 10
Parameters of Simple Synchronous Control, 301
Parameters of Software Operator's Panel, 259
Parameters of Spindle Control, 141
Parameters of the Chuck and Tailstock Barrier (16-TB), 56
Parameters of the External Pulse Input, 270
Parameters of the Hobbing Machine and Electronic Gear Box, 271
Parameters of Tool Compensation, 177
Parameters of Tool Life Management, 246
Parameters of Two-path Control, 281
Parameters of Uni-directional Positioning, 212
Parameters Related to B-Axis Control, 297
Parameters Related to Butt-Type Reference Position Setting, 257
Parameters Related to Grinding-wheel Wear Compensation, 185
Parameters Related to Path Axis Reassignment, 284
Parameters Related to Pattern Data Input, 230

[S]

Setting Parameters from MDI, 3
Straightness Compensation Parameters, 221

Revision Record

FANUC Series 16/18/160/180 MODEL C PARAMETER MANUAL (B-62760EN)

Edition	Date	Contents	Edition	Date	Contents
01	Dec., '95	_____			

- *No part of this manual may be reproduced in any form.*
- *All specifications and designs are subject to change without notice.*